

GROMACS

Groningen Machine for Chemical Simulations



USER MANUAL

Version 4.6.2

GROMACS USER MANUAL

Version 4.6.2

Contributions from

Mark Abraham, Emile Apol, Rossen Apostolov,
Herman J.C. Berendsen, Aldert van Buuren, Pär Bjelkmar,
Rudi van Drunen, Anton Feenstra, Sebastian Fritsch,
Gerrit Groenhof, Christoph Junghans, Jochen Hub, Peter Kasson,
Carsten Kutzner, Brad Lambeth, Per Larsson, Justin A. Lemkul,
Erik Marklund, Peiter Meulenhoff, Teemu Murtola,
Szilárd Páll, Sander Pronk, Roland Schulz,
Michael Shirts, Alfons Sijbers, Peter Tieleman and Maarten Wolf.
Berk Hess, David van der Spoel, and Erik Lindahl.

© 1991–2000: Department of Biophysical Chemistry, University of Groningen.
Nijenborgh 4, 9747 AG Groningen, The Netherlands.

© 2001–2013: The GROMACS development teams at the Royal Institute of Technology and
Uppsala University, Sweden.

More information can be found on our website: www.gromacs.org.

Preface & Disclaimer

This manual is not complete and has no pretention to be so due to lack of time of the contributors – our first priority is to improve the software. It is worked on continuously, which in some cases might mean the information is not entirely correct.

Comments are welcome, please send them by e-mail to gromacs@gromacs.org, or to one of the mailing lists (see www.gromacs.org).

We try to release an updated version of the manual whenever we release a new version of the software, so in general it is a good idea to use a manual with the same major and minor release number as your GROMACS installation. Any revision numbers (like 3.1.1) are however independent, to make it possible to implement bug fixes and manual improvements if necessary.

On-line Resources

You can find more documentation and other material at our homepage www.gromacs.org. Among other things there is an on-line reference, several GROMACS mailing lists with archives and contributed topologies/force fields.

Citation information

When citing this document in any scientific publication please refer to it as:

D. van der Spoel, E. Lindahl, B. Hess, and the GROMACS development team,
GROMACS User Manual version 4.6.2, www.gromacs.org (2013)

However, we prefer that you cite (some of) the GROMACS papers [1, 2, 3, 4, 5, 6] when you publish your results. Any future development depends on academic research grants, since the package is distributed as free software!

Current development

GROMACS is a joint effort, with contributions from lots of developers around the world. The core development is currently taking place at

- Department of Cellular and Molecular Biology, Uppsala University, Sweden.
(David van der Spoel).
- Stockholm Bioinformatics Center, Stockholm University, Sweden
(Erik Lindahl).
- Stockholm Bioinformatics Center, Stockholm University, Sweden
(Berk Hess)

GROMACS is *Free Software*

The entire GROMACS package is available under the GNU Lesser General Public License, version 2.1. This means it's free as in free speech, not just that you can use it without paying us money. For details, check the COPYING file in the source code or consult <http://www.gnu.org/licenses/old-licenses/lgpl-2.1.html>.

The GROMACS source code and selected set of binary packages are available on our homepage, www.gromacs.org. Have fun.

Contents

1	Introduction	1
1.1	Computational Chemistry and Molecular Modeling	1
1.2	Molecular Dynamics Simulations	2
1.3	Energy Minimization and Search Methods	5
2	Definitions and Units	7
2.1	Notation	7
2.2	MD units	7
2.3	Reduced units	9
3	Algorithms	11
3.1	Introduction	11
3.2	Periodic boundary conditions	11
3.2.1	Some useful box types	13
3.2.2	Cut-off restrictions	14
3.3	The group concept	14
3.4	Molecular Dynamics	15
3.4.1	Initial conditions	17
3.4.2	Neighbor searching	18
3.4.3	Compute forces	25
3.4.4	The leap-frog integrator	26
3.4.5	The velocity Verlet integrator	26
3.4.6	Understanding reversible integrators: The Trotter decomposition	27
3.4.7	Twin-range cut-offs	29
3.4.8	Temperature coupling	30
3.4.9	Pressure coupling	36

3.4.10	The complete update algorithm	42
3.4.11	Output step	44
3.5	Shell molecular dynamics	44
3.5.1	Optimization of the shell positions	44
3.6	Constraint algorithms	45
3.6.1	SHAKE	45
3.6.2	LINCS	46
3.7	Simulated Annealing	48
3.8	Stochastic Dynamics	49
3.9	Brownian Dynamics	50
3.10	Energy Minimization	50
3.10.1	Steepest Descent	50
3.10.2	Conjugate Gradient	51
3.10.3	L-BFGS	51
3.11	Normal-Mode Analysis	52
3.12	Free energy calculations	52
3.12.1	Slow-growth methods	52
3.12.2	Thermodynamic integration	54
3.13	Replica exchange	55
3.14	Essential Dynamics sampling	56
3.15	Expanded Ensemble	57
3.16	Parallelization	57
3.17	Particle decomposition	58
3.18	Domain decomposition	58
3.18.1	Coordinate and force communication	58
3.18.2	Dynamic load balancing	59
3.18.3	Constraints in parallel	60
3.18.4	Interaction ranges	60
3.18.5	Multiple-Program, Multiple-Data PME parallelization	62
3.18.6	Domain decomposition flow chart	63
3.19	Implicit solvation	63
4	Interaction function and force fields	67
4.1	Non-bonded interactions	67

4.1.1	The Lennard-Jones interaction	68
4.1.2	Buckingham potential	69
4.1.3	Coulomb interaction	69
4.1.4	Coulomb interaction with reaction field	70
4.1.5	Modified non-bonded interactions	71
4.1.6	Modified short-range interactions with Ewald summation	73
4.2	Bonded interactions	73
4.2.1	Bond stretching	74
4.2.2	Morse potential bond stretching	75
4.2.3	Cubic bond stretching potential	75
4.2.4	FENE bond stretching potential	76
4.2.5	Harmonic angle potential	76
4.2.6	Cosine based angle potential	77
4.2.7	Urey-Bradley potential	78
4.2.8	Bond-Bond cross term	78
4.2.9	Bond-Angle cross term	78
4.2.10	Quartic angle potential	78
4.2.11	Improper dihedrals	79
4.2.12	Proper dihedrals	80
4.2.13	Tabulated bonded interaction functions	82
4.3	Restraints	83
4.3.1	Position restraints	83
4.3.2	Angle restraints	84
4.3.3	Dihedral restraints	84
4.3.4	Distance restraints	85
4.3.5	Orientation restraints	88
4.4	Polarization	92
4.4.1	Simple polarization	92
4.4.2	Water polarization	92
4.4.3	Thole polarization	92
4.5	Free energy interactions	92
4.5.1	Soft-core interactions	95
4.6	Methods	97
4.6.1	Exclusions and 1-4 Interactions.	97

4.6.2	Charge Groups	98
4.6.3	Treatment of Cut-offs	98
4.7	Virtual interaction sites	99
4.8	Dispersion correction	103
4.8.1	Energy	103
4.8.2	Virial and pressure	104
4.9	Long Range Electrostatics	105
4.9.1	Ewald summation	105
4.9.2	PME	106
4.9.3	P3M-AD	107
4.9.4	Optimizing Fourier transforms	107
4.10	Force field	107
4.10.1	GROMOS87	108
4.10.2	GROMOS-96	108
4.10.3	OPLS/AA	110
4.10.4	AMBER	110
4.10.5	CHARMM	110
4.10.6	Coarse-grained force-fields	110
4.10.7	MARTINI	111
4.10.8	PLUM	111
5	Topologies	113
5.1	Introduction	113
5.2	Particle type	113
5.2.1	Atom types	114
5.2.2	Virtual sites	114
5.3	Parameter files	116
5.3.1	Atoms	116
5.3.2	Non-bonded parameters	116
5.3.3	Bonded parameters	117
5.3.4	Intramolecular pair interactions	118
5.3.5	Implicit solvation parameters	119
5.4	Exclusions	120
5.5	Constraint algorithms	120

5.6	pdb2gmx input files	121
5.6.1	Residue database	122
5.6.2	Residue to building block database	123
5.6.3	Atom renaming database	124
5.6.4	Hydrogen database	125
5.6.5	Termini database	126
5.6.6	Virtual site database	128
5.6.7	Special bonds	129
5.7	File formats	130
5.7.1	Topology file	130
5.7.2	Molecule.itp file	139
5.7.3	Ifdef statements	140
5.7.4	Topologies for free energy calculations	141
5.7.5	Constraint forces	144
5.7.6	Coordinate file	144
5.8	Force field organization	145
5.8.1	Force field files	145
5.8.2	Changing force field parameters	146
5.8.3	Adding atom types	147
5.9	gmx.ff documentation	147
6	Special Topics	149
6.1	Free energy implementation	149
6.2	Potential of mean force	150
6.3	Non-equilibrium pulling	151
6.4	The pull code	151
6.5	Enforced Rotation	154
6.5.1	Fixed Axis Rotation	154
6.5.2	Flexible Axis Rotation	159
6.5.3	Usage	162
6.6	Calculating a PMF using the free-energy code	165
6.7	Removing fastest degrees of freedom	165
6.7.1	Hydrogen bond-angle vibrations	166
6.7.2	Out-of-plane vibrations in aromatic groups	168

6.8	Viscosity calculation	168
6.9	Tabulated interaction functions	170
6.9.1	Cubic splines for potentials	170
6.9.2	User-specified potential functions	171
6.10	Mixed Quantum-Classical simulation techniques	172
6.10.1	Overview	173
6.10.2	Usage	173
6.10.3	Output	176
6.10.4	Future developments	176
6.11	Adaptive Resolution Scheme	176
6.11.1	Example: Adaptive resolution simulation of water	179
7	Run parameters and Programs	183
7.1	On-line and HTML manuals	183
7.2	File types	183
7.3	Run Parameters	185
7.3.1	General	185
7.3.2	Preprocessing	185
7.3.3	Run control	185
7.3.4	Langevin dynamics	188
7.3.5	Energy minimization	188
7.3.6	Shell Molecular Dynamics	188
7.3.7	Test particle insertion	189
7.3.8	Output control	189
7.3.9	Neighbor searching	190
7.3.10	Electrostatics	193
7.3.11	VdW	195
7.3.12	Tables	197
7.3.13	Ewald	197
7.3.14	Temperature coupling	198
7.3.15	Pressure coupling	199
7.3.16	Simulated annealing	201
7.3.17	Velocity generation	202
7.3.18	Bonds	202

7.3.19	Energy group exclusions	204
7.3.20	Walls	204
7.3.21	COM pulling	205
7.3.22	NMR refinement	208
7.3.23	Free energy calculations	209
7.3.24	Expanded Ensemble calculations	213
7.3.25	Non-equilibrium MD	217
7.3.26	Electric fields	217
7.3.27	Implicit solvent	219
7.3.28	Adaptive Resolution Simulation	220
7.3.29	User defined thingies	222
7.4	Programs by topic	222
8	Analysis	227
8.1	Using Groups	227
8.1.1	Default Groups	228
8.1.2	Selections	230
8.2	Looking at your trajectory	230
8.3	General properties	231
8.4	Radial distribution functions	231
8.5	Correlation functions	233
8.5.1	Theory of correlation functions	233
8.5.2	Using FFT for computation of the ACF	234
8.5.3	Special forms of the ACF	234
8.5.4	Some Applications	234
8.6	Mean Square Displacement	235
8.7	Bonds, angles and dihedrals	235
8.8	Radius of gyration and distances	237
8.9	Root mean square deviations in structure	238
8.10	Covariance analysis	239
8.11	Dihedral principal component analysis	241
8.12	Hydrogen bonds	241
8.13	Protein-related items	242
8.14	Interface-related items	243

8.15	Chemical shifts	245
A	Technical Details	247
A.1	Installation	247
A.2	Single or Double precision	247
A.3	Porting GROMACS	248
A.4	Environment Variables	248
A.5	Running GROMACS in parallel	255
A.6	Running GROMACS on GPUs	255
B	Some implementation details	257
B.1	Single Sum Virial in GROMACS	257
B.1.1	Virial	257
B.1.2	Virial from non-bonded forces	258
B.1.3	The intra-molecular shift (mol-shift)	258
B.1.4	Virial from Covalent Bonds	259
B.1.5	Virial from SHAKE	260
B.2	Optimizations	260
B.2.1	Inner Loops for Water	260
B.2.2	Fortran Code	261
B.3	Computation of the 1.0/sqrt function	261
B.3.1	Introduction	261
B.3.2	General	261
B.3.3	Applied to floating-point numbers	262
B.3.4	Specification of the look-up table	263
B.3.5	Separate exponent and fraction computation	264
B.3.6	Implementation	265
B.4	Modifying GROMACS	265
C	Averages and fluctuations	267
C.1	Formulae for averaging	267
C.2	Implementation	268
C.2.1	Part of a Simulation	269
C.2.2	Combining two simulations	269
C.2.3	Summing energy terms	270

D	Manual Pages	273
D.1	Standard options for GROMACS tools	273
D.2	do_dssp	274
D.3	editconf	275
D.4	eneconv	277
D.5	g_anadock	277
D.6	g_anaeig	278
D.7	g_analyze	280
D.8	g_angle	282
D.9	g_bar	283
D.10	g_bond	284
D.11	g_bundle	285
D.12	g_chi	286
D.13	g_cluster	288
D.14	g_clustsize	290
D.15	g_confrms	291
D.16	g_covar	291
D.17	g_current	292
D.18	g_density	293
D.19	g_densmap	294
D.20	g_densorder	295
D.21	g_dielectric	296
D.22	g_dipoles	297
D.23	g_disre	299
D.24	g_dist	299
D.25	g_dos	300
D.26	g_dyecoupl	301
D.27	g_dyndom	302
D.28	genbox	302
D.29	genconf	304
D.30	g_enemat	304
D.31	g_energy	305
D.32	genion	308
D.33	genrestr	309

D.34 g_filter	309
D.35 g_gyrate	310
D.36 g_h2order	311
D.37 g_hbond	312
D.38 g_helix	314
D.39 g_helixorient	315
D.40 g_hydorder	316
D.41 g_kinetics	316
D.42 g_lie	317
D.43 g_mdmat	318
D.44 g_membed	318
D.45 g_mindist	320
D.46 g_morph	321
D.47 g_msdc	321
D.48 gmxcheck	323
D.49 gmxdump	323
D.50 g_nmeig	324
D.51 g_nmens	325
D.52 g_nmtraj	326
D.53 g_order	326
D.54 g_pme_error	327
D.55 g_polystat	328
D.56 g_potential	328
D.57 g_principal	329
D.58 g_protonate	330
D.59 g_rama	330
D.60 g_rdf	330
D.61 g_rms	332
D.62 g_rmsdist	333
D.63 g_rmsf	334
D.64 grompp	335
D.65 g_rotacf	336
D.66 g_rotmat	337
D.67 g_saltbr	338

D.68 g_sans	338
D.69 g_sas	339
D.70 g_select	340
D.71 g_sgangle	342
D.72 g_sham	343
D.73 g_sigeps	344
D.74 g_sorient	344
D.75 g_spatial	345
D.76 g_spol	347
D.77 g_tcaf	347
D.78 g_traj	348
D.79 g_tune_pme	350
D.80 g_vanhove	352
D.81 g_velacc	353
D.82 g_wham	354
D.83 g_wheel	357
D.84 g_x2top	357
D.85 g_xrama	358
D.86 make_edi	359
D.87 make_ndx	361
D.88 mdrun	361
D.89 mk_angndx	367
D.90 ngmx	367
D.91 pdb2gmx	368
D.92 tpbconv	370
D.93 trjcat	371
D.94 trjconv	372
D.95 trjorder	374
D.96 xpm2ps	375
Bibliography	377
Index	389

Chapter 1

Introduction

1.1 Computational Chemistry and Molecular Modeling

GROMACS is an engine to perform molecular dynamics simulations and energy minimization. These are two of the many techniques that belong to the realm of computational chemistry and molecular modeling. *Computational chemistry* is just a name to indicate the use of computational techniques in chemistry, ranging from quantum mechanics of molecules to dynamics of large complex molecular aggregates. *Molecular modeling* indicates the general process of describing complex chemical systems in terms of a realistic atomic model, with the goal being to understand and predict macroscopic properties based on detailed knowledge on an atomic scale. Often, molecular modeling is used to design new materials, for which the accurate prediction of physical properties of realistic systems is required.

Macroscopic physical properties can be distinguished by (a) *static equilibrium properties*, such as the binding constant of an inhibitor to an enzyme, the average potential energy of a system, or the radial distribution function of a liquid, and (b) *dynamic or non-equilibrium properties*, such as the viscosity of a liquid, diffusion processes in membranes, the dynamics of phase changes, reaction kinetics, or the dynamics of defects in crystals. The choice of technique depends on the question asked and on the feasibility of the method to yield reliable results at the present state of the art. Ideally, the (relativistic) time-dependent Schrödinger equation describes the properties of molecular systems with high accuracy, but anything more complex than the equilibrium state of a few atoms cannot be handled at this *ab initio* level. Thus, approximations are necessary; the higher the complexity of a system and the longer the time span of the processes of interest is, the more severe the required approximations are. At a certain point (reached very much earlier than one would wish), the *ab initio* approach must be augmented or replaced by *empirical* parameterization of the model used. Where simulations based on physical principles of atomic interactions still fail due to the complexity of the system, molecular modeling is based entirely on a similarity analysis of known structural and chemical data. The QSAR methods (Quantitative Structure-Activity Relations) and many homology-based protein structure predictions belong to the latter category.

Macroscopic properties are always ensemble averages over a representative statistical ensemble

(either equilibrium or non-equilibrium) of molecular systems. For molecular modeling, this has two important consequences:

- The knowledge of a single structure, even if it is the structure of the global energy minimum, is not sufficient. It is necessary to generate a representative ensemble at a given temperature, in order to compute macroscopic properties. But this is not enough to compute thermodynamic equilibrium properties that are based on free energies, such as phase equilibria, binding constants, solubilities, relative stability of molecular conformations, etc. The computation of free energies and thermodynamic potentials requires special extensions of molecular simulation techniques.
- While molecular simulations, in principle, provide atomic details of the structures and motions, such details are often not relevant for the macroscopic properties of interest. This opens the way to simplify the description of interactions and average over irrelevant details. The science of statistical mechanics provides the theoretical framework for such simplifications. There is a hierarchy of methods ranging from considering groups of atoms as one unit, describing motion in a reduced number of collective coordinates, averaging over solvent molecules with potentials of mean force combined with stochastic dynamics [7], to *mesoscopic dynamics* describing densities rather than atoms and fluxes as response to thermodynamic gradients rather than velocities or accelerations as response to forces [8].

For the generation of a representative equilibrium ensemble two methods are available: (a) *Monte Carlo simulations* and (b) *Molecular Dynamics simulations*. For the generation of non-equilibrium ensembles and for the analysis of dynamic events, only the second method is appropriate. While Monte Carlo simulations are more simple than MD (they do not require the computation of forces), they do not yield significantly better statistics than MD in a given amount of computer time. Therefore, MD is the more universal technique. If a starting configuration is very far from equilibrium, the forces may be excessively large and the MD simulation may fail. In those cases, a robust *energy minimization* is required. Another reason to perform an energy minimization is the removal of all kinetic energy from the system: if several “snapshots” from dynamic simulations must be compared, energy minimization reduces the thermal noise in the structures and potential energies so that they can be compared better.

1.2 Molecular Dynamics Simulations

MD simulations solve Newton’s equations of motion for a system of N interacting atoms:

$$m_i \frac{\partial^2 \mathbf{r}_i}{\partial t^2} = \mathbf{F}_i, \quad i = 1 \dots N. \quad (1.1)$$

The forces are the negative derivatives of a potential function $V(\mathbf{r}_1, \mathbf{r}_2, \dots, \mathbf{r}_N)$:

$$\mathbf{F}_i = -\frac{\partial V}{\partial \mathbf{r}_i} \quad (1.2)$$

The equations are solved simultaneously in small time steps. The system is followed for some time, taking care that the temperature and pressure remain at the required values, and the coordinates are written to an output file at regular intervals. The coordinates as a function of time

type of bond	type of vibration	wavenumber (cm ⁻¹)
C-H, O-H, N-H	stretch	3000–3500
C=C, C=O	stretch	1700–2000
HOH	bending	1600
C-C	stretch	1400–1600
H ₂ CX	sciss, rock	1000–1500
CCC	bending	800–1000
O-H···O	libration	400– 700
O-H···O	stretch	50– 200

Table 1.1: Typical vibrational frequencies (wavenumbers) in molecules and hydrogen-bonded liquids. Compare $kT/h = 200 \text{ cm}^{-1}$ at 300 K.

represent a *trajectory* of the system. After initial changes, the system will usually reach an *equilibrium state*. By averaging over an equilibrium trajectory, many macroscopic properties can be extracted from the output file.

It is useful at this point to consider the limitations of MD simulations. The user should be aware of those limitations and always perform checks on known experimental properties to assess the accuracy of the simulation. We list the approximations below.

The simulations are classical

Using Newton's equation of motion automatically implies the use of *classical mechanics* to describe the motion of atoms. This is all right for most atoms at normal temperatures, but there are exceptions. Hydrogen atoms are quite light and the motion of protons is sometimes of essential quantum mechanical character. For example, a proton may *tunnel* through a potential barrier in the course of a transfer over a hydrogen bond. Such processes cannot be properly treated by classical dynamics! Helium liquid at low temperature is another example where classical mechanics breaks down. While helium may not deeply concern us, the high frequency vibrations of covalent bonds should make us worry! The statistical mechanics of a classical harmonic oscillator differs appreciably from that of a real quantum oscillator when the resonance frequency ν approximates or exceeds $k_B T/h$. Now at room temperature the wavenumber $\sigma = 1/\lambda = \nu/c$ at which $h\nu = k_B T$ is approximately 200 cm^{-1} . Thus, all frequencies higher than, say, 100 cm^{-1} may misbehave in classical simulations. This means that practically all bond and bond-angle vibrations are suspect, and even hydrogen-bonded motions as translational or librational H-bond vibrations are beyond the classical limit (see Table 1.1). What can we do?

Well, apart from real quantum-dynamical simulations, we can do one of two things:

(a) If we perform MD simulations using harmonic oscillators for bonds, we should make corrections to the total internal energy $U = E_{kin} + E_{pot}$ and specific heat C_V (and to entropy S and free energy A or G if those are calculated). The corrections to the energy and specific heat of a one-dimensional oscillator with frequency ν are: [9]

$$U^{QM} = U^{cl} + kT \left(\frac{1}{2}x - 1 + \frac{x}{e^x - 1} \right) \quad (1.3)$$

$$C_V^{QM} = C_V^{cl} + k \left(\frac{x^2 e^x}{(e^x - 1)^2} - 1 \right), \quad (1.4)$$

where $x = h\nu/kT$. The classical oscillator absorbs too much energy (kT), while the high-frequency quantum oscillator is in its ground state at the zero-point energy level of $\frac{1}{2}h\nu$.

(b) We can treat the bonds (and bond angles) as *constraints* in the equations of motion. The rationale behind this is that a quantum oscillator in its ground state resembles a constrained bond more closely than a classical oscillator. A good practical reason for this choice is that the algorithm can use larger time steps when the highest frequencies are removed. In practice the time step can be made four times as large when bonds are constrained than when they are oscillators [10]. GROMACS has this option for the bonds and bond angles. The flexibility of the latter is rather essential to allow for the realistic motion and coverage of configurational space [11].

Electrons are in the ground state

In MD we use a *conservative* force field that is a function of the positions of atoms only. This means that the electronic motions are not considered: the electrons are supposed to adjust their dynamics instantly when the atomic positions change (the *Born-Oppenheimer* approximation), and remain in their ground state. This is really all right, almost always. But of course, electron transfer processes and electronically excited states can not be treated. Neither can chemical reactions be treated properly, but there are other reasons to shy away from reactions for the time being.

Force fields are approximate

Force fields provide the forces. They are not really a part of the simulation method and their parameters can be modified by the user as the need arises or knowledge improves. But the form of the forces that can be used in a particular program is subject to limitations. The force field that is incorporated in GROMACS is described in Chapter 4. In the present version the force field is pair-additive (apart from long-range Coulomb forces), it cannot incorporate polarizabilities, and it does not contain fine-tuning of bonded interactions. This urges the inclusion of some limitations in this list below. For the rest it is quite useful and fairly reliable for biologically-relevant macromolecules in aqueous solution!

The force field is pair-additive

This means that all *non-bonded* forces result from the sum of non-bonded pair interactions. Non pair-additive interactions, the most important example of which is interaction through atomic polarizability, are represented by *effective pair potentials*. Only average non pair-additive contributions are incorporated. This also means that the pair interactions are not pure, *i.e.*, they are not valid for isolated pairs or for situations that differ appreciably from the test systems on which the models were parameterized. In fact, the effective pair potentials are not that bad in practice. But the omission of polarizability also means that electrons in atoms do not provide a dielectric constant as they should. For example, real liquid alkanes have a dielectric constant of slightly more than 2, which reduce the long-range electrostatic interaction between (partial) charges. Thus, the simulations will exaggerate the long-range Coulomb terms. Luckily, the next item compensates this effect a bit.

Long-range interactions are cut off

In this version, GROMACS always uses a cut-off radius for the Lennard-Jones interactions

and sometimes for the Coulomb interactions as well. The “minimum-image convention” used by GROMACS requires that only one image of each particle in the periodic boundary conditions is considered for a pair interaction, so the cut-off radius cannot exceed half the box size. That is still pretty big for large systems, and trouble is only expected for systems containing charged particles. But then truly bad things can happen, like accumulation of charges at the cut-off boundary or very wrong energies! For such systems, you should consider using one of the implemented long-range electrostatic algorithms, such as particle-mesh Ewald [12, 13].

Boundary conditions are unnatural

Since system size is small (even 10,000 particles is small), a cluster of particles will have a lot of unwanted boundary with its environment (vacuum). We must avoid this condition if we wish to simulate a bulk system. As such, we use periodic boundary conditions to avoid real phase boundaries. Since liquids are not crystals, something unnatural remains. This item is mentioned last because it is the least of the evils. For large systems, the errors are small, but for small systems with a lot of internal spatial correlation, the periodic boundaries may enhance internal correlation. In that case, beware of, and test, the influence of system size. This is especially important when using lattice sums for long-range electrostatics, since these are known to sometimes introduce extra ordering.

1.3 Energy Minimization and Search Methods

As mentioned in sec. 1.1, in many cases energy minimization is required. GROMACS provides a number of methods for local energy minimization, as detailed in sec. 3.10.

The potential energy function of a (macro)molecular system is a very complex landscape (or *hypersurface*) in a large number of dimensions. It has one deepest point, the *global minimum* and a very large number of *local minima*, where all derivatives of the potential energy function with respect to the coordinates are zero and all second derivatives are non-negative. The matrix of second derivatives, which is called the *Hessian matrix*, has non-negative eigenvalues; only the collective coordinates that correspond to translation and rotation (for an isolated molecule) have zero eigenvalues. In between the local minima there are *saddle points*, where the Hessian matrix has only one negative eigenvalue. These points are the mountain passes through which the system can migrate from one local minimum to another.

Knowledge of all local minima, including the global one, and of all saddle points would enable us to describe the relevant structures and conformations and their free energies, as well as the dynamics of structural transitions. Unfortunately, the dimensionality of the configurational space and the number of local minima is so high that it is impossible to sample the space at a sufficient number of points to obtain a complete survey. In particular, no minimization method exists that guarantees the determination of the global minimum in any practical amount of time. Impractical methods exist, some much faster than others [14]. However, given a starting configuration, it is possible to find the *nearest local minimum*. “Nearest” in this context does not always imply “nearest” in a geometrical sense (*i.e.*, the least sum of square coordinate differences), but means the minimum that can be reached by systematically moving down the steepest local gradient. Finding this nearest local minimum is all that GROMACS can do for you, sorry! If you want to find other

minima and hope to discover the global minimum in the process, the best advice is to experiment with temperature-coupled MD: run your system at a high temperature for a while and then quench it slowly down to the required temperature; do this repeatedly! If something as a melting or glass transition temperature exists, it is wise to stay for some time slightly below that temperature and cool down slowly according to some clever scheme, a process called *simulated annealing*. Since no physical truth is required, you can use your imagination to speed up this process. One trick that often works is to make hydrogen atoms heavier (mass 10 or so): although that will slow down the otherwise very rapid motions of hydrogen atoms, it will hardly influence the slower motions in the system, while enabling you to increase the time step by a factor of 3 or 4. You can also modify the potential energy function during the search procedure, *e.g.* by removing barriers (remove dihedral angle functions or replace repulsive potentials by *soft-core* potentials [15]), but always take care to restore the correct functions slowly. The best search method that allows rather drastic structural changes is to allow excursions into four-dimensional space [16], but this requires some extra programming beyond the standard capabilities of GROMACS.

Three possible energy minimization methods are:

- Those that require only function evaluations. Examples are the simplex method and its variants. A step is made on the basis of the results of previous evaluations. If derivative information is available, such methods are inferior to those that use this information.
- Those that use derivative information. Since the partial derivatives of the potential energy with respect to all coordinates are known in MD programs (these are equal to minus the forces) this class of methods is very suitable as modification of MD programs.
- Those that use second derivative information as well. These methods are superior in their convergence properties near the minimum: a quadratic potential function is minimized in one step! The problem is that for N particles a $3N \times 3N$ matrix must be computed, stored, and inverted. Apart from the extra programming to obtain second derivatives, for most systems of interest this is beyond the available capacity. There are intermediate methods that build up the Hessian matrix on the fly, but they also suffer from excessive storage requirements. So GROMACS will shy away from this class of methods.

The *steepest descent* method, available in GROMACS, is of the second class. It simply takes a step in the direction of the negative gradient (hence in the direction of the force), without any consideration of the history built up in previous steps. The step size is adjusted such that the search is fast, but the motion is always downhill. This is a simple and sturdy, but somewhat stupid, method: its convergence can be quite slow, especially in the vicinity of the local minimum! The faster-converging *conjugate gradient method* (see *e.g.* [17]) uses gradient information from previous steps. In general, steepest descents will bring you close to the nearest local minimum very quickly, while conjugate gradients brings you *very* close to the local minimum, but performs worse far away from the minimum. GROMACS also supports the L-BFGS minimizer, which is mostly comparable to *conjugate gradient method*, but in some cases converges faster.

Chapter 2

Definitions and Units

2.1 Notation

The following conventions for mathematical typesetting are used throughout this document:

Item	Notation	Example
Vector	Bold italic	\mathbf{r}_i
Vector Length	Italic	r_i

We define the *lowercase* subscripts i , j , k and l to denote particles: \mathbf{r}_i is the *position vector* of particle i , and using this notation:

$$\mathbf{r}_{ij} = \mathbf{r}_j - \mathbf{r}_i \quad (2.1)$$

$$r_{ij} = |\mathbf{r}_{ij}| \quad (2.2)$$

The force on particle i is denoted by \mathbf{F}_i and

$$\mathbf{F}_{ij} = \text{force on } i \text{ exerted by } j \quad (2.3)$$

Please note that we changed notation as of version 2.0 to $\mathbf{r}_{ij} = \mathbf{r}_j - \mathbf{r}_i$ since this is the notation commonly used. If you encounter an error, let us know.

2.2 MD units

GROMACS uses a consistent set of units that produce values in the vicinity of unity for most relevant molecular quantities. Let us call them *MD units*. The basic units in this system are nm, ps, K, electron charge (e) and atomic mass unit (u), see Table 2.1.

Consistent with these units are a set of derived units, given in Table 2.2.

The **electric conversion factor** $f = \frac{1}{4\pi\epsilon_0} = 138.935\,485(9) \text{ kJ mol}^{-1} \text{ nm e}^{-2}$. It relates the mechanical quantities to the electrical quantities as in

$$V = f \frac{q^2}{r} \text{ or } F = f \frac{q^2}{r^2} \quad (2.4)$$

Quantity	Symbol	Unit
length	r	nm = 10^{-9} m
mass	m	u (atomic mass unit) = $1.6605402(10) \times 10^{-27}$ kg (1/12 the mass of a ^{12}C atom) $1.6605402(10) \times 10^{-27}$ kg
time	t	ps = 10^{-12} s
charge	q	e = electronic charge = $1.60217733(49) \times 10^{-19}$ C
temperature	T	K

Table 2.1: Basic units used in GROMACS. Numbers in parentheses give accuracy.

Quantity	Symbol	Unit
energy	E, V	kJ mol^{-1}
Force	\mathbf{F}	$\text{kJ mol}^{-1} \text{ nm}^{-1}$
pressure	p	$\text{kJ mol}^{-1} \text{ nm}^{-3} = 10^{30}/N_{AV}$ Pa $1.660\,54 \times 10^6$ Pa = 16.6054 bar
velocity	v	$\text{nm ps}^{-1} = 1000 \text{ m s}^{-1}$
dipole moment	μ	$e \text{ nm}$
electric potential	Φ	$\text{kJ mol}^{-1} e^{-1} = 0.010\,364\,272(3)$ Volt
electric field	E	$\text{kJ mol}^{-1} \text{ nm}^{-1} e^{-1} = 1.036\,427\,2(3) \times 10^7$ V m^{-1}

Table 2.2: Derived units

Electric potentials Φ and electric fields \mathbf{E} are intermediate quantities in the calculation of energies and forces. They do not occur inside GROMACS. If they are used in evaluations, there is a choice of equations and related units. We strongly recommend following the usual practice of including the factor f in expressions that evaluate Φ and \mathbf{E} :

$$\Phi(\mathbf{r}) = f \sum_j \frac{q_j}{|\mathbf{r} - \mathbf{r}_j|} \quad (2.5)$$

$$\mathbf{E}(\mathbf{r}) = f \sum_j q_j \frac{(\mathbf{r} - \mathbf{r}_j)}{|\mathbf{r} - \mathbf{r}_j|^3} \quad (2.6)$$

With these definitions, $q\Phi$ is an energy and $q\mathbf{E}$ is a force. The units are those given in Table 2.2: about 10 mV for potential. Thus, the potential of an electronic charge at a distance of 1 nm equals $f \approx 140$ units ≈ 1.4 V. (exact value: 1.439965 V)

Note that these units are mutually consistent; changing any of the units is likely to produce inconsistencies and is therefore *strongly discouraged!* In particular: if \AA are used instead of nm, the unit of time changes to 0.1 ps. If kcal mol^{-1} ($= 4.184 \text{ kJ mol}^{-1}$) is used instead of kJ mol^{-1} for energy, the unit of time becomes 0.488882 ps and the unit of temperature changes to 4.184 K. But in both cases all electrical energies go wrong, because they will still be computed in kJ mol^{-1} , expecting nm as the unit of length. Although careful rescaling of charges may still yield consistency, it is clear that such confusions must be rigidly avoided.

In terms of the MD units, the usual physical constants take on different values (see Table 2.3). All quantities are per mol rather than per molecule. There is no distinction between Boltzmann's constant k and the gas constant R : their value is $0.008\,314\,51 \text{ kJ mol}^{-1} \text{ K}^{-1}$.

Symbol	Name	Value
N_{AV}	Avogadro's number	$6.022\,136\,7(36) \times 10^{23} \text{ mol}^{-1}$
R	gas constant	$8.314\,510(70) \times 10^{-3} \text{ kJ mol}^{-1} \text{ K}^{-1}$
k_B	Boltzmann's constant	<i>idem</i>
h	Planck's constant	$0.399\,031\,32(24) \text{ kJ mol}^{-1} \text{ ps}$
\hbar	Dirac's constant	$0.063\,507\,807(38) \text{ kJ mol}^{-1} \text{ ps}$
c	velocity of light	$299\,792.458 \text{ nm ps}^{-1}$

Table 2.3: Some Physical Constants

Quantity	Symbol	Relation to SI
Length	r^*	$r \sigma^{-1}$
Mass	m^*	$m M^{-1}$
Time	t^*	$t \sigma^{-1} \sqrt{\epsilon/M}$
Temperature	T^*	$k_B T \epsilon^{-1}$
Energy	E^*	$E \epsilon^{-1}$
Force	F^*	$F \sigma \epsilon^{-1}$
Pressure	P^*	$P \sigma^3 \epsilon^{-1}$
Velocity	v^*	$v \sqrt{M/\epsilon}$
Density	ρ^*	$N \sigma^3 V^{-1}$

Table 2.4: Reduced Lennard-Jones quantities

2.3 Reduced units

When simulating Lennard-Jones (LJ) systems, it might be advantageous to use reduced units (*i.e.*, setting $\epsilon_{ii} = \sigma_{ii} = m_i = k_B = 1$ for one type of atoms). This is possible. When specifying the input in reduced units, the output will also be in reduced units. The one exception is the *temperature*, which is expressed in 0.008 314 51 reduced units. This is a consequence of using Boltzmann's constant in the evaluation of temperature in the code. Thus not T , but $k_B T$, is the reduced temperature. A GROMACS temperature $T = 1$ means a reduced temperature of 0.008 . . . units; if a reduced temperature of 1 is required, the GROMACS temperature should be 120.2717.

In Table 2.4 quantities are given for LJ potentials:

$$V_{LJ} = 4\epsilon \left[\left(\frac{\sigma}{r} \right)^{12} - \left(\frac{\sigma}{r} \right)^6 \right] \quad (2.7)$$

Chapter 3

Algorithms

3.1 Introduction

In this chapter we first give describe some general concepts used in GROMACS: *periodic boundary conditions* (sec. 3.2) and the *group concept* (sec. 3.3). The MD algorithm is described in sec. 3.4: first a global form of the algorithm is given, which is refined in subsequent subsections. The (simple) EM (Energy Minimization) algorithm is described in sec. 3.10. Some other algorithms for special purpose dynamics are described after this.

A few issues are of general interest. In all cases the *system* must be defined, consisting of molecules. Molecules again consist of particles with defined interaction functions. The detailed description of the *topology* of the molecules and of the *force field* and the calculation of forces is given in chapter 4. In the present chapter we describe other aspects of the algorithm, such as pair list generation, update of velocities and positions, coupling to external temperature and pressure, conservation of constraints. The *analysis* of the data generated by an MD simulation is treated in chapter 8.

3.2 Periodic boundary conditions

The classical way to minimize edge effects in a finite system is to apply *periodic boundary conditions*. The atoms of the system to be simulated are put into a space-filling box, which is surrounded by translated copies of itself (Fig. 3.1). Thus there are no boundaries of the system; the artifact caused by unwanted boundaries in an isolated cluster is now replaced by the artifact of periodic conditions. If the system is crystalline, such boundary conditions are desired (although motions are naturally restricted to periodic motions with wavelengths fitting into the box). If one wishes to simulate non-periodic systems, such as liquids or solutions, the periodicity by itself causes errors. The errors can be evaluated by comparing various system sizes; they are expected to be less severe than the errors resulting from an unnatural boundary with vacuum.

There are several possible shapes for space-filling unit cells. Some, like the *rhombic dodecahedron* and the *truncated octahedron* [18] are closer to being a sphere than a cube is, and are therefore

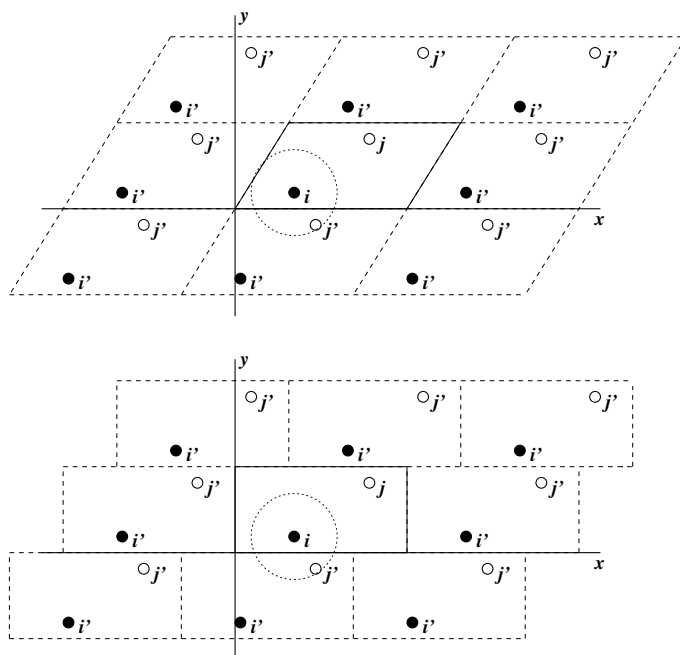

Figure 3.1: Periodic boundary conditions in two dimensions.

better suited to the study of an approximately spherical macromolecule in solution, since fewer solvent molecules are required to fill the box given a minimum distance between macromolecular images. At the same time, rhombic dodecahedra and truncated octahedra are special cases of *triclinic* unit cells; the most general space-filling unit cells that comprise all possible space-filling shapes [19]. For this reason, GROMACS is based on the triclinic unit cell.

GROMACS uses periodic boundary conditions, combined with the *minimum image convention*: only one – the nearest – image of each particle is considered for short-range non-bonded interaction terms. For long-range electrostatic interactions this is not always accurate enough, and GROMACS therefore also incorporates lattice sum methods such as Ewald Sum, PME and PPPM.

GROMACS supports triclinic boxes of any shape. The simulation box (unit cell) is defined by the 3 box vectors \mathbf{a} , \mathbf{b} and \mathbf{c} . The box vectors must satisfy the following conditions:

$$a_y = a_z = b_z = 0 \quad (3.1)$$

$$a_x > 0, \quad b_y > 0, \quad c_z > 0 \quad (3.2)$$

$$|b_x| \leq \frac{1}{2} a_x, \quad |c_x| \leq \frac{1}{2} a_x, \quad |c_y| \leq \frac{1}{2} b_y \quad (3.3)$$

Equations 3.1 can always be satisfied by rotating the box. Inequalities (3.2) and (3.3) can always be satisfied by adding and subtracting box vectors.

Even when simulating using a triclinic box, GROMACS always keeps the particles in a brick-shaped volume for efficiency, as illustrated in Fig. 3.1 for a 2-dimensional system. Therefore, from the output trajectory it might seem that the simulation was done in a rectangular box. The program `trjconv` can be used to convert the trajectory to a different unit-cell representation.

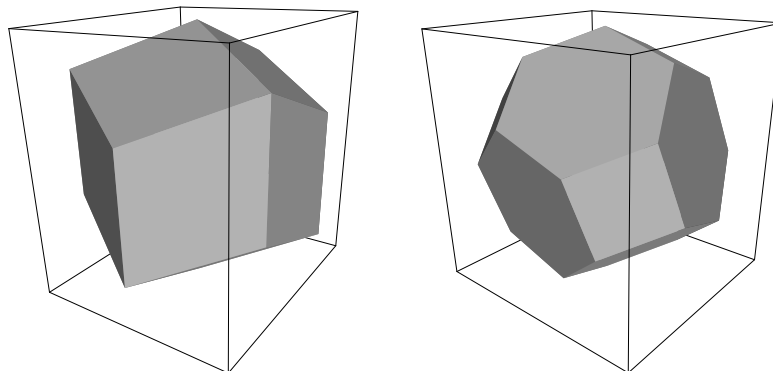

Figure 3.2: A rhombic dodecahedron and truncated octahedron (arbitrary orientations).

box type	image distance	box volume	box vectors			box vector angles		
			a	b	c	$\angle bc$	$\angle ac$	$\angle ab$
cubic	d	d^3	d 0 0	0 d 0	0 0 d	90°	90°	90°
rhombic dodecahedron (xy-square)	d	$\frac{1}{2}\sqrt{2}d^3$ $0.707d^3$	d 0 0	0 d 0	$\frac{1}{2}d$ $\frac{1}{2}d$ $\frac{1}{2}\sqrt{2}d$	60°	60°	90°
rhombic dodecahedron (xy-hexagon)	d	$\frac{1}{2}\sqrt{2}d^3$ $0.707d^3$	d 0 0	$\frac{1}{2}d$ $\frac{1}{2}\sqrt{3}d$ 0	$\frac{1}{2}d$ $\frac{1}{6}\sqrt{3}d$ $\frac{1}{3}\sqrt{6}d$	60°	60°	60°
truncated octahedron	d	$\frac{4}{9}\sqrt{3}d^3$ $0.770d^3$	d 0 0	$\frac{1}{3}d$ $\frac{2}{3}\sqrt{2}d$ 0	$-\frac{1}{3}d$ $\frac{1}{3}\sqrt{2}d$ $\frac{1}{3}\sqrt{6}d$	71.53°	109.47°	71.53°

Table 3.1: The cubic box, the rhombic dodecahedron and the truncated octahedron.

It is also possible to simulate without periodic boundary conditions, but it is usually more efficient to simulate an isolated cluster of molecules in a large periodic box, since fast grid searching can only be used in a periodic system.

3.2.1 Some useful box types

The three most useful box types for simulations of solvated systems are described in Table 3.1. The rhombic dodecahedron (Fig. 3.2) is the smallest and most regular space-filling unit cell. Each of the 12 image cells is at the same distance. The volume is 71% of the volume of a cube having the same image distance. This saves about 29% of CPU-time when simulating a spherical or flexible molecule in solvent. There are two different orientations of a rhombic dodecahedron that satisfy equations 3.1, 3.2 and 3.3. The program `editconf` produces the orientation which has a square intersection with the xy-plane. This orientation was chosen because the first two box vectors coincide with the x and y-axis, which is easier to comprehend. The other orientation can

be useful for simulations of membrane proteins. In this case the cross-section with the xy-plane is a hexagon, which has an area which is 14% smaller than the area of a square with the same image distance. The height of the box (c_z) should be changed to obtain an optimal spacing. This box shape not only saves CPU time, it also results in a more uniform arrangement of the proteins.

3.2.2 Cut-off restrictions

The minimum image convention implies that the cut-off radius used to truncate non-bonded interactions may not exceed half the shortest box vector:

$$R_c < \frac{1}{2} \min(\|\mathbf{a}\|, \|\mathbf{b}\|, \|\mathbf{c}\|), \quad (3.4)$$

because otherwise more than one image would be within the cut-off distance of the force. When a macromolecule, such as a protein, is studied in solution, this restriction alone is not sufficient: in principle, a single solvent molecule should not be able to ‘see’ both sides of the macromolecule. This means that the length of each box vector must exceed the length of the macromolecule in the direction of that edge *plus* two times the cut-off radius R_c . It is, however, common to compromise in this respect, and make the solvent layer somewhat smaller in order to reduce the computational cost. For efficiency reasons the cut-off with triclinic boxes is more restricted. For grid search the extra restriction is weak:

$$R_c < \min(a_x, b_y, c_z) \quad (3.5)$$

For simple search the extra restriction is stronger:

$$R_c < \frac{1}{2} \min(a_x, b_y, c_z) \quad (3.6)$$

Each unit cell (cubic, rectangular or triclinic) is surrounded by 26 translated images. A particular image can therefore always be identified by an index pointing to one of 27 *translation vectors* and constructed by applying a translation with the indexed vector (see 3.4.3). Restriction (3.5) ensures that only 26 images need to be considered.

3.3 The group concept

The GROMACS MD and analysis programs use user-defined *groups* of atoms to perform certain actions on. The maximum number of groups is 256, but each atom can only belong to six different groups, one each of the following:

temperature-coupling group **temperature-coupling group** The temperature coupling parameters (reference temperature, time constant, number of degrees of freedom, see 3.4.4) can be defined for each T-coupling group separately. For example, in a solvated macromolecule the solvent (that tends to generate more heating by force and integration errors) can be coupled with a shorter time constant to a bath than is a macromolecule, or a surface can be kept cooler than an adsorbing molecule. Many different T-coupling groups may be defined. See also center of mass groups below.

freeze group Atoms that belong to a freeze group are kept stationary in the dynamics. This is useful during equilibration, *e.g.* to avoid badly placed solvent molecules giving unreasonable kicks to protein atoms, although the same effect can also be obtained by putting a restraining potential on the atoms that must be protected. The freeze option can be used, if desired, on just one or two coordinates of an atom, thereby freezing the atoms in a plane or on a line. When an atom is partially frozen, constraints will still be able to move it, even in a frozen direction. A fully frozen atom can not be moved by constraints. Many freeze groups can be defined. Frozen coordinates are unaffected by pressure scaling; in some cases this can produce unwanted results, particularly when constraints are also used (in this case you will get very large pressures). Accordingly, it is recommended to avoid combining freeze groups with constraints and pressure coupling. For the sake of equilibration it could suffice to start with freezing in a constant volume simulation, and afterward use position restraints in conjunction with constant pressure.

accelerate group On each atom in an “accelerate group” an acceleration a^g is imposed. This is equivalent to an external force. This feature makes it possible to drive the system into a non-equilibrium state and enables the performance of non-equilibrium MD and hence to obtain transport properties.

energy-monitor group Mutual interactions between all energy-monitor groups are compiled during the simulation. This is done separately for Lennard-Jones and Coulomb terms. In principle up to 256 groups could be defined, but that would lead to 256×256 items! Better use this concept sparingly.

All non-bonded interactions between pairs of energy-monitor groups can be excluded (see sec. 7.3). Pairs of particles from excluded pairs of energy-monitor groups are not put into the pair list. This can result in a significant speedup for simulations where interactions within or between parts of the system are not required.

center of mass group In GROMACS the center of mass (COM) motion can be removed, for either the complete system or for groups of atoms. The latter is useful, *e.g.* for systems where there is limited friction (*e.g.* gas systems) to prevent center of mass motion to occur. It makes sense to use the same groups for temperature coupling and center of mass motion removal.

XTC output group In order to reduce the size of the `.xtc` trajectory file, only a subset of all particles can be stored. All XTC groups that are specified are saved, the rest is not. If no XTC groups are specified, then all atoms are saved to the `.xtc` file.

The use of groups in GROMACS tools is described in sec. 8.1.

3.4 Molecular Dynamics

A global flow scheme for MD is given in Fig. 3.3. Each MD or EM run requires as input a set of initial coordinates and – optionally – initial velocities of all particles involved. This chapter does not describe how these are obtained; for the setup of an actual MD run check the online manual at www.gromacs.org.

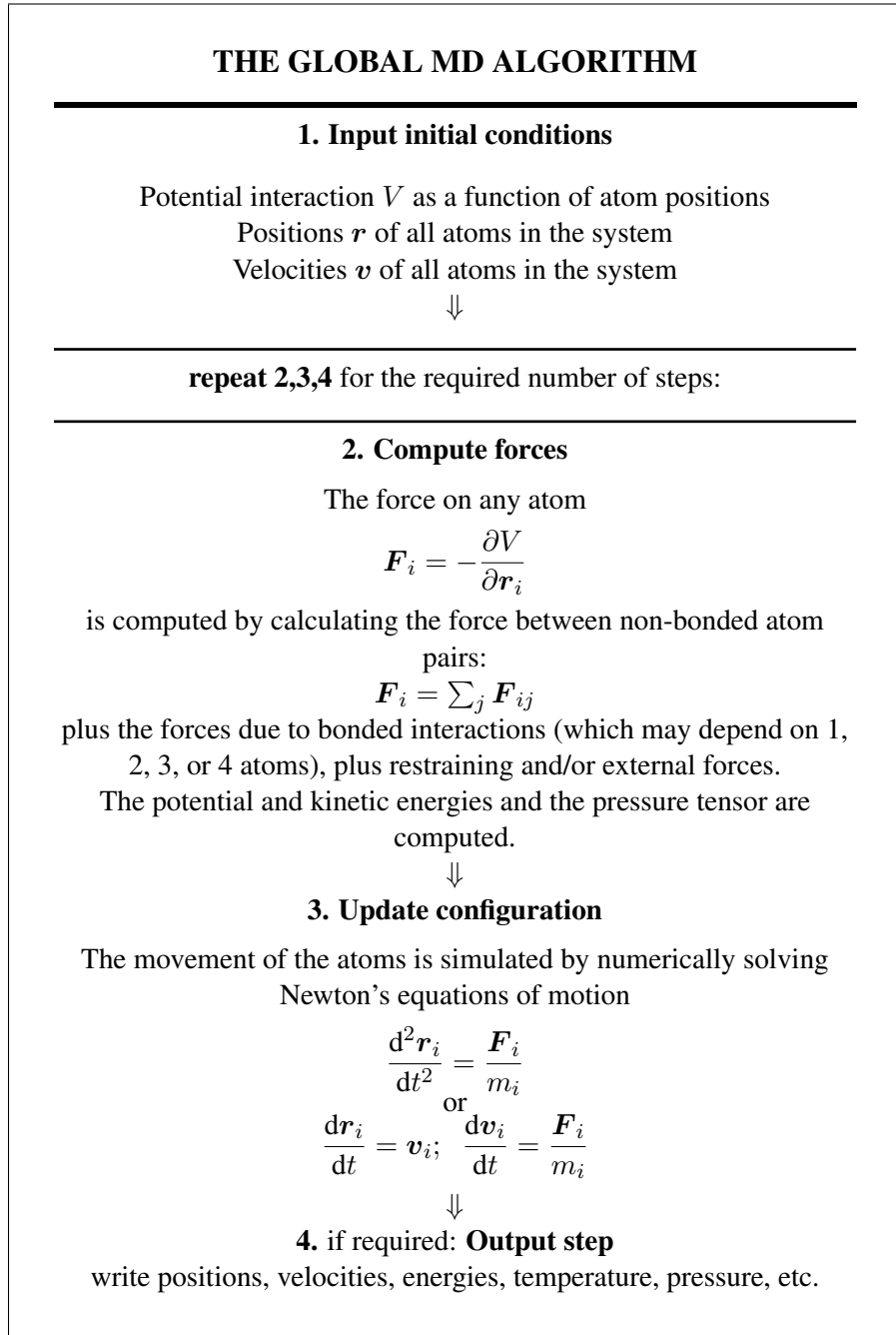

Figure 3.3: The global MD algorithm

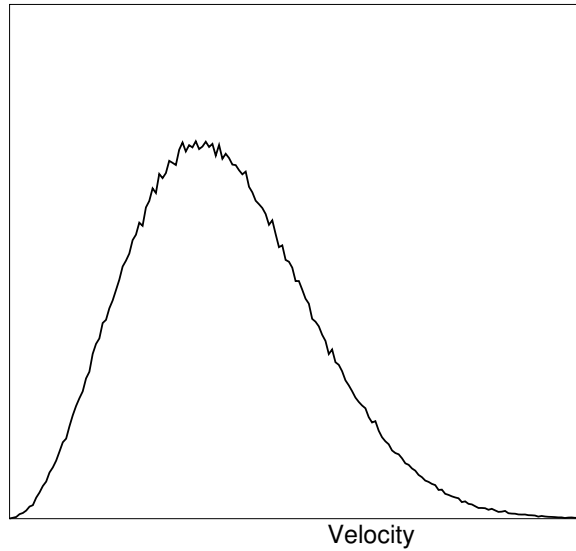

Figure 3.4: A Maxwell-Boltzmann velocity distribution, generated from random numbers.

3.4.1 Initial conditions

Topology and force field

The system topology, including a description of the force field, must be read in. Force fields and topologies are described in chapter 4 and 5, respectively. All this information is static; it is never modified during the run.

Coordinates and velocities

Then, before a run starts, the box size and the coordinates and velocities of all particles are required. The box size and shape is determined by three vectors (nine numbers) $\mathbf{b}_1, \mathbf{b}_2, \mathbf{b}_3$, which represent the three basis vectors of the periodic box.

If the run starts at $t = t_0$, the coordinates at $t = t_0$ must be known. The *leap-frog algorithm*, the default algorithm used to update the time step with Δt (see 3.4.4), also requires that the velocities at $t = t_0 - \frac{1}{2}\Delta t$ are known. If velocities are not available, the program can generate initial atomic velocities $v_i, i = 1 \dots 3N$ with a (Fig. 3.4) at a given absolute temperature T :

$$p(v_i) = \sqrt{\frac{m_i}{2\pi kT}} \exp\left(-\frac{m_i v_i^2}{2kT}\right) \quad (3.7)$$

where k is Boltzmann's constant (see chapter 2). To accomplish this, normally distributed random numbers are generated by adding twelve random numbers R_k in the range $0 \leq R_k < 1$ and subtracting 6.0 from their sum. The result is then multiplied by the standard deviation of the velocity distribution $\sqrt{kT/m_i}$. Since the resulting total energy will not correspond exactly to the required temperature T , a correction is made: first the center-of-mass motion is removed and then all velocities are scaled so that the total energy corresponds exactly to T (see eqn. 3.18).

Center-of-mass motion

The center-of-mass velocity is normally set to zero at every step; there is (usually) no net external force acting on the system and the center-of-mass velocity should remain constant. In practice, however, the update algorithm introduces a very slow change in the center-of-mass velocity, and therefore in the total kinetic energy of the system – especially when temperature coupling is used. If such changes are not quenched, an appreciable center-of-mass motion can develop in long runs, and the temperature will be significantly misinterpreted. Something similar may happen due to overall rotational motion, but only when an isolated cluster is simulated. In periodic systems with filled boxes, the overall rotational motion is coupled to other degrees of freedom and does not cause such problems.

3.4.2 Neighbor searching

As mentioned in chapter 4, internal forces are either generated from fixed (static) lists, or from dynamic lists. The latter consist of non-bonded interactions between any pair of particles. When calculating the non-bonded forces, it is convenient to have all particles in a rectangular box. As shown in Fig. 3.1, it is possible to transform a triclinic box into a rectangular box. The output coordinates are always in a rectangular box, even when a dodecahedron or triclinic box was used for the simulation. Equation 3.1 ensures that we can reset particles in a rectangular box by first shifting them with box vector \mathbf{c} , then with \mathbf{b} and finally with \mathbf{a} . Equations 3.3, 3.4 and 3.5 ensure that we can find the 14 nearest triclinic images within a linear combination that does not involve multiples of box vectors.

Pair lists generation

The non-bonded pair forces need to be calculated only for those pairs i, j for which the distance r_{ij} between i and the nearest image of j is less than a given cut-off radius R_c . Some of the particle pairs that fulfill this criterion are excluded, when their interaction is already fully accounted for by bonded interactions. GROMACS employs a *pair list* that contains those particle pairs for which non-bonded forces must be calculated. The pair list contains atoms i , a displacement vector for atom i , and all particles j that are within `rlist` of this particular image of atom i . The list is updated every `nstlist` steps, where `nstlist` is typically 10. There is an option to calculate the total non-bonded force on each particle due to all particle in a shell around the list cut-off, *i.e.* at a distance between `rlist` and `rlistlong`. This force is calculated during the pair list update and retained during `nstlist` steps.

To make the neighbor list, all particles that are close (*i.e.* within the neighbor list cut-off) to a given

particle must be found. This searching, usually called neighbor search (NS) or pair search, involves periodic boundary conditions and determining the *image* (see sec. 3.2). The search algorithm is $O(N)$, although a simpler $O(N^2)$ algorithm is still available under some conditions.

Cut-off schemes: group versus Verlet

From version 4.6, GROMACS supports two different cut-off scheme setups: the original one based on atom groups and one using a Verlet buffer. There are some important differences that affect results, performance and feature support. The group scheme can be made to work (almost) like the Verlet scheme, but this will lead to a decrease in performance. The group scheme is especially fast for water molecules, which are abundant in many simulations.

In the group scheme, a neighbor list is generated consisting of pairs of groups of at least one atom. These groups were originally charge groups (see sec. 3.4.2), but with a proper treatment of long-range electrostatics, performance is their only advantage. A pair of groups is put into the neighbor list when their center of geometry is within the cut-off distance. Interactions between all atom pairs (one from each charge group) are calculated for a certain number of MD steps, until the neighbor list is updated. This setup is efficient, as the neighbor search only checks distance between charge group pair, not atom pairs (saves a factor of $3 \times 3 = 9$ with a three-atom water model) and the non-bonded force kernels can be optimized for, say, a water molecule “group”. Without explicit buffering, this setup leads to energy drift as some atom pairs which are within the cut-off don’t interact and some outside the cut-off do interact. This can be caused by

- atoms moving across the cut-off between neighbor search steps, and/or
- for charge groups consisting of more than one atom, atom pairs moving in/out of the cut-off when their charge group center of geometry distance is outside/inside of the cut-off.

Explicitly adding a buffer to the neighbor list will remove such artifacts, but this comes at a high computational cost. How severe the artifacts are depends on the system, the properties in which you are interested, and the cut-off setup.

The Verlet cut-off scheme uses a buffered pair list by default. It also uses clusters of atoms, but these are not static as in the group scheme. Rather, the clusters are defined spatially and consist of 4 or 8 atoms, which is convenient for stream computing, using e.g. SSE, AVX or CUDA on GPUs. At neighbor search steps, an atom pair list (or cluster pair list, but that’s an implementation detail) is created with a Verlet buffer. Thus the pair-list cut-off is larger than the interaction cut-off. In the non-bonded force kernels, forces are only added when an atom pair is within the cut-off distance at that particular time step. This ensures that as atoms move between pair search steps, forces between nearly all atoms within the cut-off distance are calculated. We say *nearly* all atoms, because GROMACS uses a fixed pair list update frequency for efficiency. There is a small chance that an atom pair distance is decreased to within the cut-off in this fixed number of steps. This small chance results in a small energy drift. When temperature coupling is used, the buffer size can be determined automatically, given a certain limit on the energy drift.

The Verlet scheme specific settings in the `mdp` file are:

```
cutoff-scheme          = Verlet
verlet-buffer-drift    = 0.005
```

Non-bonded interaction feature	group	Verlet
unbuffered cut-off scheme	✓	
exact cut-off	shift/switch	✓
shifted interactions	force+energy	energy
switched forces	✓	
non-periodic systems	✓	Z + walls
implicit solvent	✓	
free energy perturbed non-bondeds	✓	
group energy contributions	✓	CPU (not on GPU)
energy group exclusions	✓	
AdResS multi-scale	✓	
OpenMP multi-threading	only PME	✓
native GPU support		✓

Table 3.2: Differences (only) in the support of non-bonded features between the group and Verlet cut-off schemes.

The Verlet buffer size is determined from the latter option, which is by default set to 0.005 kJ/mol/ps energy drift per atom. Note that the total energy drift in the system is affected by many factors and it is usually much smaller than this default setting for the estimate. For constant energy (NVE) simulations, this drift should be set to -1 and a buffer has to be set manually by specifying `rlist > rcoulomb`. The simplest way to get a reasonable buffer size is to use an NVT `mdp` file with the target temperature set to what you expect in your NVE simulation, and transfer the buffer size printed by `grompp` to your NVE `mdp` file.

The Verlet cut-off scheme is implemented in a very efficient fashion based on clusters of particles. The simplest example is a cluster size of 4 particles. The pair list is then constructed based on cluster pairs. The cluster-pair search is much faster searching based on particle pairs, because $4 \times 4 = 16$ particle pairs are put in the list at once. The non-bonded force calculation kernel can then calculate all 16 particle-pair interactions at once, which maps nicely to SIMD units which can perform multiple floating operations at once (e.g. SSE, AVX, CUDA on GPUs, BlueGene FPU). These non-bonded kernels are much faster than the kernels used in the group scheme for most types of systems, except for water molecules when not using a buffered pair list. This latter case is quite common for (bio-)molecular simulations, so for greatest speed, it is worth comparing the performance of both schemes.

As the Verlet cut-off scheme was introduced in version 4.6, not all features of the group scheme are supported yet. The Verlet scheme supports a few new features which the group scheme does not support. A list of features not (fully) supported in both cut-off schemes is given in Table 3.2.

Energy drift and pair-list buffering

For a canonical ensemble, the average energy drift caused by the finite Verlet buffer size can be determined from the atomic displacements and the shape of the potential at the cut-off. The displacement distribution along one dimension for a freely moving particle with mass m over time t at temperature T is Gaussian with zero mean and variance $\sigma^2 = t k_B T / m$. For the distance

between two atoms, the variance changes to $\sigma^2 = \sigma_{12}^2 = t k_B T (1/m_1 + 1/m_2)$. Note that in practice particles usually interact with other particles over time t and therefore the real displacement distribution is much narrower. Given a non-bonded interaction cut-off distance of r_c and a pair-list cut-off $r_\ell = r_c + r_b$, we can then write the average energy drift after time t for pair interactions between one particle of type 1 surrounded by particles of type 2 with number density ρ_2 , when the inter particle distance changes from r_0 to r_t , as:

$$\langle \Delta V \rangle = \int_0^{r_c} \int_{r_\ell}^{\infty} 4\pi r_0^2 \rho_2 V(r_t) G\left(\frac{r_t - r_0}{\sigma}\right) dr_0 dr_t \quad (3.8)$$

$$\approx \int_{-\infty}^{r_c} \int_{r_\ell}^{\infty} 4\pi r_0^2 \rho_2 \left[V'(r_c)(r_t - r_c) + V''(r_c) \frac{1}{2}(r_t - r_c)^2 \right] G\left(\frac{r_t - r_0}{\sigma}\right) dr_0 dr_t \quad (3.9)$$

$$\approx 4\pi(r_\ell + \sigma)^2 \rho_2 \int_{-\infty}^{r_c} \int_{r_\ell}^{\infty} \left[V'(r_c)(r_t - r_c) + V''(r_c) \frac{1}{2}(r_t - r_c)^2 \right] G\left(\frac{r_t - r_0}{\sigma}\right) dr_0 dr_t \quad (3.10)$$

$$= 4\pi(r_\ell + \sigma)^2 \rho_2 \left\{ \frac{1}{2} V'(r_c) \left[r_b \sigma G\left(\frac{r_b}{\sigma}\right) - (r_b^2 + \sigma^2) E\left(\frac{r_b}{\sigma}\right) \right] + \frac{1}{6} V''(r_c) \left[\sigma(r_b^2 + \sigma^2) G\left(\frac{r_b}{\sigma}\right) - r_b(r_b^2 + 3\sigma^2) E\left(\frac{r_b}{\sigma}\right) \right] \right\} \quad (3.11)$$

where G is a Gaussian distribution with 0 mean and unit variance and $E(x) = \frac{1}{2} \text{erfc}(x/\sqrt{2})$. We always want to achieve small energy drift, so σ will be small compared to both r_c and r_ℓ , thus the approximations in the equations above are good, since the Gaussian distribution decays rapidly. The energy drift needs to be averaged over all particle pair types and weighted with the particle counts. In GROMACS we don't allow cancellation of drift between pair types, so we average the absolute values. To obtain the average energy drift per unit time, it needs to be divided by the neighbor-list life time $t = (\text{nstlist} - 1) \times \text{dt}$. This function can not be inverted analytically, so we use bisection to obtain the buffer size r_b for a target drift. Again we note that in practice the drift we usually be much smaller than this estimate, as in the condensed phase particle displacements will be much smaller than for freely moving particles, which is the assumption used here.

When (bond) constraints are present, some particles will have fewer degrees of freedom. This will reduce the energy drift. The displacement in an arbitrary direction of a particle with 2 degrees of freedom is not Gaussian, but rather follows the complementary error function:

$$\frac{\sqrt{\pi}}{2\sqrt{2}\sigma} \text{erfc}\left(\frac{|r|}{\sqrt{2}\sigma}\right) \quad (3.12)$$

where σ^2 is again $k_B T/m$. This distribution can no longer be integrated analytically to obtain the energy drift. But we can generate a tight upper bound using a scaled and shifted Gaussian distribution (not shown). This Gaussian distribution can then be used to calculate the energy drift as described above. We consider particles constrained, i.e. having 2 degrees of freedom or fewer, when they are connected by constraints to particles with a total mass of at least 1.5 times the mass of the particles itself. For a particle with a single constraint this would give a total mass along the

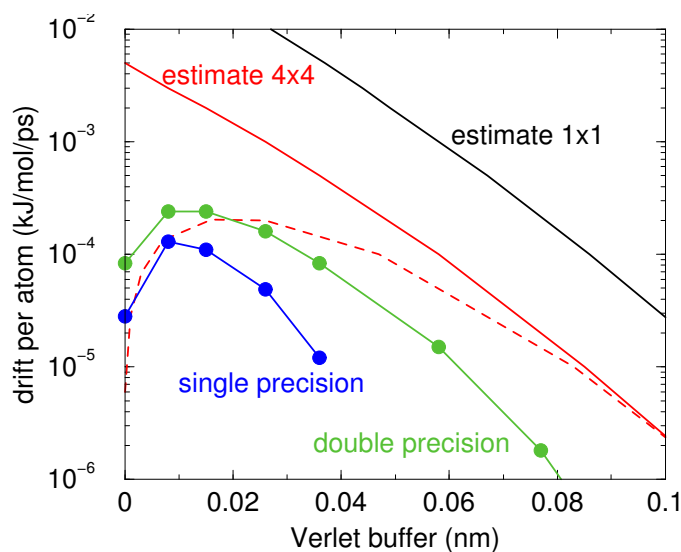

Figure 3.5: Energy drift per atom for an SPC/E water system at 300K with a time step of 2 fs and a pair-list update period of 10 steps (pair-list life time: 18 fs). PME was used with `ewald-rtol` set to 10^{-5} ; this parameter affects the shape of the potential at the cut-off. Drift estimates due to finite Verlet buffer size are shown for a 1×1 atom pair list and 4×4 atom pair list without and with (dashed line) cancellation of positive and negative drift. Real energy drift is shown for double- and single-precision simulations. Single-precision rounding errors in the SETTLE constraint algorithm cause the drift to become negative at large buffer size. Note that at zero buffer size, the real drift is small because the positive (H-H) and negative (O-H) drift cancels.

constraint direction of at least 2.5, which leads to a reduction in the variance of the displacement along that direction by at least a factor of 6.25. As the Gaussian distribution decays very rapidly, this effectively removes one degree of freedom from the displacement. Multiple constraints would reduce the displacement even more, but as this gets very complex, we consider those as particles with 2 degrees of freedom.

There is one important implementation detail that reduces the energy drift caused by the finite Verlet buffer list size. The derivation above assumes a particle pair-list. However, the GROMACS implementation uses a cluster pair-list for efficiency. The pair list consists of pairs of clusters of 4 particles in most cases, also called a 4×4 list, but the list can also be 4×8 (GPU CUDA kernels and AVX 256-bit single precision kernels) or 4×2 (SSE double-precision kernels). This means that the pair-list is effectively much larger than the corresponding 1×1 list. Thus slightly beyond the pair-list cut-off there will still be a large fraction of particle pairs present in the list. This fraction can be determined in a simulation and accurately estimated under some reasonable assumptions. The fraction decreases with increasing pair-list range, meaning that a smaller buffer can be used. For typical all-atom simulations with a cut-off of 0.9 nm this fraction is around 0.9, which gives a reduction in the energy drift of a factor of 10. This reduction is taken into account during the automatic Verlet buffer calculation and results in a smaller buffer size.

In Fig. 3.5 one can see that for water with a pair-list life time of 18 fs, the drift estimate is a factor of 6 higher than the real drift, or alternatively the buffer estimate is 0.024 nm too large. This is

because the protons don't move freely over 18 fs, but rather vibrate.

Cut-off artifacts and switched interactions

With the Verlet scheme, the pair potentials are shifted to be zero at the cut-off, such that the potential is the integral of the force. Note that in the group scheme this is not possible, because no exact cut-off distance is used. There can still be energy drift from non-zero forces at the cut-off. This effect is extremely small and often not noticeable, as other integration errors may dominate. To completely avoid cut-off artifacts, the non-bonded forces can be switched exactly to zero at some distance smaller than the neighbor list cut-off (there are several ways to do this in GROMACS, see sec. 4.1.5). One then has a buffer with the size equal to the neighbor list cut-off less the longest interaction cut-off. With the group cut-off scheme, one can then also choose to let `mdrun` only update the neighbor list when required. That is when one or more particles have moved more than half the buffer size from the center of geometry of the charge group to which they belong (see sec. 3.4.2), as determined at the previous neighbor search. This option guarantees that there are no cut-off artifacts. **Note** that for larger systems this comes at a high computational cost, since the neighbor list update frequency will be determined by just one or two particles moving slightly beyond the half buffer length (which not even necessarily implies that the neighbor list is invalid), while 99.99% of the particles are fine. `ifthenelse test for gmxlite`

Simple search

Due to eqns. 3.1 and 3.6, the vector \mathbf{r}_{ij} connecting images within the cut-off R_c can be found by constructing:

$$\mathbf{r}''' = \mathbf{r}_j - \mathbf{r}_i \quad (3.13)$$

$$\mathbf{r}'' = \mathbf{r}''' - \mathbf{c} * \text{round}(r_z'''/c_z) \quad (3.14)$$

$$\mathbf{r}' = \mathbf{r}'' - \mathbf{b} * \text{round}(r_y''/b_y) \quad (3.15)$$

$$\mathbf{r}_{ij} = \mathbf{r}' - \mathbf{a} * \text{round}(r_x'/a_x) \quad (3.16)$$

When distances between two particles in a triclinic box are needed that do not obey eqn. 3.1, many shifts of combinations of box vectors need to be considered to find the nearest image.

Grid search

The grid search is schematically depicted in Fig. 3.6. All particles are put on the NS grid, with the smallest spacing $\geq R_c/2$ in each of the directions. In the direction of each box vector, a particle i has three images. For each direction the image may be -1, 0 or 1, corresponding to a translation over -1, 0 or +1 box vector. We do not search the surrounding NS grid cells for neighbors of i and then calculate the image, but rather construct the images first and then search neighbors corresponding to that image of i . As Fig. 3.6 shows, some grid cells may be searched more than once for different images of i . This is not a problem, since, due to the minimum image convention, at most one image will "see" the j -particle. For every particle, fewer than 125 (5^3) neighboring cells are searched. Therefore, the algorithm scales linearly with the number of particles. Although the prefactor is large, the scaling behavior makes the algorithm far superior over the standard

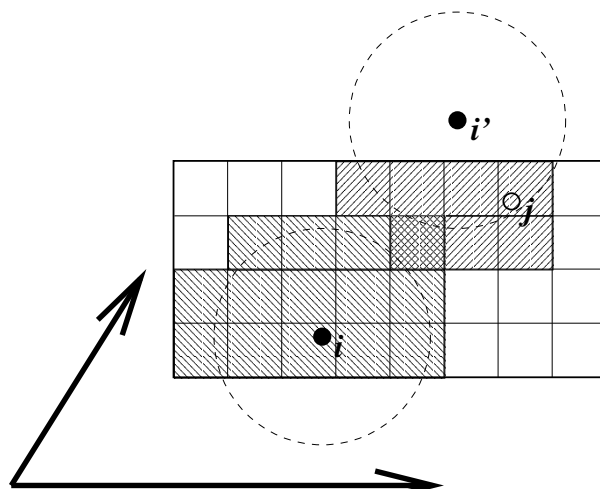

Figure 3.6: Grid search in two dimensions. The arrows are the box vectors.

$O(N^2)$ algorithm when there are more than a few hundred particles. The grid search is equally fast for rectangular and triclinic boxes. Thus for most protein and peptide simulations the rhombic dodecahedron will be the preferred box shape.

Charge groups

Charge groups were originally introduced to reduce cut-off artifacts of Coulomb interactions. When a plain cut-off is used, significant jumps in the potential and forces arise when atoms with (partial) charges move in and out of the cut-off radius. When all chemical moieties have a net charge of zero, these jumps can be reduced by moving groups of atoms with net charge zero, called charge groups, in and out of the neighbor list. This reduces the cut-off effects from the charge-charge level to the dipole-dipole level, which decay much faster. With the advent of full range electrostatics methods, such as particle mesh Ewald (sec. 4.9.2), the use of charge groups is no longer required for accuracy. It might even have a slight negative effect on the accuracy or efficiency, depending on how the neighbor list is made and the interactions are calculated.

But there is still an important reason for using “charge groups”: efficiency. Where applicable, neighbor searching is carried out on the basis of charge groups which are defined in the molecular topology. If the nearest image distance between the *geometrical centers* of the atoms of two charge groups is less than the cut-off radius, all atom pairs between the charge groups are included in the pair list. The neighbor searching for a water system, for instance, is $3^2 = 9$ times faster when each molecule is treated as a charge group. Also the highly optimized water force loops (see sec. B.2.1) only work when all atoms in a water molecule form a single charge group. Currently the name *neighbor-search group* would be more appropriate, but the name charge group is retained for historical reasons. When developing a new force field, the advice is to use charge groups of 3 to 4 atoms for optimal performance. For all-atom force fields this is relatively easy, as one can simply put hydrogen atoms, and in some case oxygen atoms, in the same charge group as the heavy atom they are connected to; for example: CH_3 , CH_2 , CH , NH_2 , NH , OH , CO_2 , CO .

3.4.3 Compute forces

Potential energy

When forces are computed, the potential energy of each interaction term is computed as well. The total potential energy is summed for various contributions, such as Lennard-Jones, Coulomb, and bonded terms. It is also possible to compute these contributions for *energy-monitor groups* of atoms that are separately defined (see sec. 3.3).

Kinetic energy and temperature

The temperature is given by the total kinetic energy of the N -particle system:

$$E_{kin} = \frac{1}{2} \sum_{i=1}^N m_i v_i^2 \quad (3.17)$$

From this the absolute temperature T can be computed using:

$$\frac{1}{2} N_{df} k T = E_{kin} \quad (3.18)$$

where k is Boltzmann's constant and N_{df} is the number of degrees of freedom which can be computed from:

$$N_{df} = 3N - N_c - N_{com} \quad (3.19)$$

Here N_c is the number of *constraints* imposed on the system. When performing molecular dynamics $N_{com} = 3$ additional degrees of freedom must be removed, because the three center-of-mass velocities are constants of the motion, which are usually set to zero. When simulating in vacuo, the rotation around the center of mass can also be removed, in this case $N_{com} = 6$. When more than one temperature-coupling group is used, the number of degrees of freedom for group i is:

$$N_{df}^i = (3N^i - N_c^i) \frac{3N - N_c - N_{com}}{3N - N_c} \quad (3.20)$$

The kinetic energy can also be written as a tensor, which is necessary for pressure calculation in a triclinic system, or systems where shear forces are imposed:

$$\mathbf{E}_{kin} = \frac{1}{2} \sum_i^N m_i \mathbf{v}_i \otimes \mathbf{v}_i \quad (3.21)$$

Pressure and virial

The pressure tensor \mathbf{P} is calculated from the difference between kinetic energy E_{kin} and the virial $\mathbf{\Xi}$:

$$\mathbf{P} = \frac{2}{V} (\mathbf{E}_{kin} - \mathbf{\Xi}) \quad (3.22)$$

where V is the volume of the computational box. The scalar pressure P , which can be used for pressure coupling in the case of isotropic systems, is computed as:

$$P = \text{trace}(\mathbf{P})/3 \quad (3.23)$$

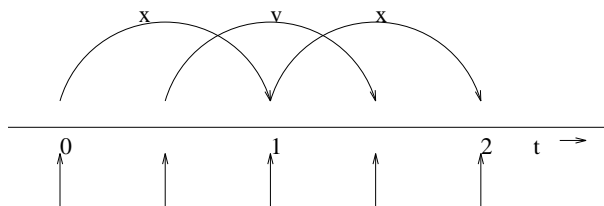

Figure 3.7: The Leap-Frog integration method. The algorithm is called Leap-Frog because \mathbf{r} and \mathbf{v} are leaping like frogs over each other's backs.

The virial Ξ tensor is defined as:

$$\Xi = -\frac{1}{2} \sum_{i < j} \mathbf{r}_{ij} \otimes \mathbf{F}_{ij} \quad (3.24)$$

The GROMACS implementation of the virial computation is described in sec. B.1.

3.4.4 The leap-frog integrator

The default MD integrator in GROMACS is the so-called *leap-frog* algorithm [20] for the integration of the equations of motion. When extremely accurate integration with temperature and/or pressure coupling is required, the velocity Verlet integrators are also present and may be preferable (see 3.4.5). The leap-frog algorithm uses positions \mathbf{r} at time t and velocities \mathbf{v} at time $t - \frac{1}{2}\Delta t$; it updates positions and velocities using the forces $\mathbf{F}(t)$ determined by the positions at time t using these relations:

$$\mathbf{v}(t + \frac{1}{2}\Delta t) = \mathbf{v}(t - \frac{1}{2}\Delta t) + \frac{\Delta t}{m} \mathbf{F}(t) \quad (3.25)$$

$$\mathbf{r}(t + \Delta t) = \mathbf{r}(t) + \Delta t \mathbf{v}(t + \frac{1}{2}\Delta t) \quad (3.26)$$

The algorithm is visualized in Fig. 3.7. It produces trajectories that are identical to the Verlet [21] algorithm, whose position-update relation is

$$\mathbf{r}(t + \Delta t) = 2\mathbf{r}(t) - \mathbf{r}(t - \Delta t) + \frac{1}{m} \mathbf{F}(t) \Delta t^2 + O(\Delta t^4) \quad (3.27)$$

The algorithm is of third order in \mathbf{r} and is time-reversible. See ref. [22] for the merits of this algorithm and comparison with other time integration algorithms.

The equations of motion are modified for temperature coupling and pressure coupling, and extended to include the conservation of constraints, all of which are described below.

3.4.5 The velocity Verlet integrator

The velocity Verlet algorithm [23] is also implemented in GROMACS, though it is not yet fully integrated with all sets of options. In velocity Verlet, positions \mathbf{r} and velocities \mathbf{v} at time t are used

to integrate the equations of motion; velocities at the previous half step are not required.

$$\mathbf{v}(t + \frac{1}{2}\Delta t) = \mathbf{v}(t) + \frac{\Delta t}{2m}\mathbf{F}(t) \quad (3.28)$$

$$\mathbf{r}(t + \Delta t) = \mathbf{r}(t) + \Delta t \mathbf{v}(t + \frac{1}{2}\Delta t) \quad (3.29)$$

$$\mathbf{v}(t + \Delta t) = \mathbf{v}(t + \frac{1}{2}\Delta t) + \frac{\Delta t}{2m}\mathbf{F}(t + \Delta t) \quad (3.30)$$

or, equivalently,

$$\mathbf{r}(t + \Delta t) = \mathbf{r}(t) + \Delta t \mathbf{v} + \frac{\Delta t^2}{2m}\mathbf{F}(t) \quad (3.31)$$

$$\mathbf{v}(t + \Delta t) = \mathbf{v}(t) + \frac{\Delta t}{2m}[\mathbf{F}(t) + \mathbf{F}(t + \Delta t)] \quad (3.32)$$

With no temperature or pressure coupling, and with *corresponding* starting points, leap-frog and velocity Verlet will generate identical trajectories, as can easily be verified by hand from the equations above. Given a single starting file with the *same* starting point $\mathbf{x}(0)$ and $\mathbf{v}(0)$, leap-frog and velocity Verlet will *not* give identical trajectories, as leap-frog will interpret the velocities as corresponding to $t = -\frac{1}{2}\Delta t$, while velocity Verlet will interpret them as corresponding to the timepoint $t = 0$.

3.4.6 Understanding reversible integrators: The Trotter decomposition

To further understand the relationship between velocity Verlet and leap-frog integration, we introduce the reversible Trotter formulation of dynamics, which is also useful to understanding implementations of thermostats and barostats in GROMACS.

A system of coupled, first-order differential equations can be evolved from time $t = 0$ to time t by applying the evolution operator

$$\begin{aligned} \Gamma(t) &= \exp(iLt)\Gamma(0) \\ iL &= \dot{\Gamma} \cdot \nabla_{\Gamma}, \end{aligned} \quad (3.33)$$

where L is the Liouville operator, and Γ is the multidimensional vector of independent variables (positions and velocities). A short-time approximation to the true operator, accurate at time $\Delta t = t/P$, is applied P times in succession to evolve the system as

$$\Gamma(t) = \prod_{i=1}^P \exp(iL\Delta t)\Gamma(0) \quad (3.34)$$

For NVE dynamics, the Liouville operator is

$$iL = \sum_{i=1}^N \mathbf{v}_i \cdot \nabla_{\mathbf{r}_i} + \sum_{i=1}^N \frac{1}{m_i} \mathbf{F}(r_i) \cdot \nabla_{\mathbf{v}_i}. \quad (3.35)$$

This can be split into two additive operators

$$\begin{aligned} iL_1 &= \sum_{i=1}^N \frac{1}{m_i} \mathbf{F}(r_i) \cdot \nabla \mathbf{v}_i \\ iL_2 &= \sum_{i=1}^N \mathbf{v}_i \cdot \nabla \mathbf{r}_i \end{aligned} \quad (3.36)$$

Then a short-time, symmetric, and thus reversible approximation of the true dynamics will be

$$\exp(iL\Delta t) = \exp(iL_2 \frac{1}{2} \Delta t) \exp(iL_1 \Delta t) \exp(iL_2 \frac{1}{2} \Delta t) + \mathcal{O}(\Delta t^3). \quad (3.37)$$

This corresponds to velocity Verlet integration. The first exponential term over $\frac{1}{2} \Delta t$ corresponds to a velocity half-step, the second exponential term over Δt corresponds to a full velocity step, and the last exponential term over $\frac{1}{2} \Delta t$ is the final velocity half step. For future times $t = n\Delta t$, this becomes

$$\begin{aligned} \exp(iLn\Delta t) &\approx \left(\exp(iL_2 \frac{1}{2} \Delta t) \exp(iL_1 \Delta t) \exp(iL_2 \frac{1}{2} \Delta t) \right)^n \\ &\approx \exp(iL_2 \frac{1}{2} \Delta t) \left(\exp(iL_1 \Delta t) \exp(iL_2 \Delta t) \right)^{n-1} \\ &\quad \exp(iL_1 \Delta t) \exp(iL_2 \frac{1}{2} \Delta t) \end{aligned} \quad (3.38)$$

This formalism allows us to easily see the difference between the different flavors of Verlet integrators. The leap-frog integrator can be seen as starting with Eq. 3.37 with the $\exp(iL_1 \Delta t)$ term, instead of the half-step velocity term, yielding

$$\exp(iLn\Delta t) = \exp(iL_1 \Delta t) \exp(iL_2 \Delta t) + \mathcal{O}(\Delta t^3). \quad (3.39)$$

Here, the full step in velocity is between $t - \frac{1}{2} \Delta t$ and $t + \frac{1}{2} \Delta t$, since it is a combination of the velocity half steps in velocity Verlet. For future times $t = n\Delta t$, this becomes

$$\exp(iLn\Delta t) \approx \left(\exp(iL_1 \Delta t) \exp(iL_2 \Delta t) \right)^n. \quad (3.40)$$

Although at first this does not appear symmetric, as long as the full velocity step is between $t - \frac{1}{2} \Delta t$ and $t + \frac{1}{2} \Delta t$, then this is simply a way of starting velocity Verlet at a different place in the cycle.

Even though the trajectory and thus potential energies are identical between leap-frog and velocity Verlet, the kinetic energy and temperature will not necessarily be the same. Standard velocity Verlet uses the velocities at the t to calculate the kinetic energy and thus the temperature only at time t ; the kinetic energy is then a sum over all particles

$$\begin{aligned} KE_{\text{full}}(t) &= \sum_i \left(\frac{1}{2m_i} \mathbf{v}_i(t) \right)^2 \\ &= \sum_i \frac{1}{2m_i} \left(\frac{1}{2} \mathbf{v}_i(t - \frac{1}{2} \Delta t) + \frac{1}{2} \mathbf{v}_i(t + \frac{1}{2} \Delta t) \right)^2, \end{aligned} \quad (3.41)$$

with the square on the *outside* of the average. Standard leap-frog calculates the kinetic energy at time t based on the average kinetic energies at the timesteps $t + \frac{1}{2}\Delta t$ and $t - \frac{1}{2}\Delta t$, or the sum over all particles

$$KE_{\text{average}}(t) = \sum_i \frac{1}{2m_i} \left(\frac{1}{2} \mathbf{v}_i(t - \frac{1}{2}\Delta t)^2 + \frac{1}{2} \mathbf{v}_i(t + \frac{1}{2}\Delta t)^2 \right), \quad (3.42)$$

where the square is *inside* the average.

A non-standard variant of velocity Verlet which averages the kinetic energies $KE(t + \frac{1}{2}\Delta t)$ and $KE(t - \frac{1}{2}\Delta t)$, exactly like leap-frog, is also now implemented in GROMACS (as `.mdp` file option `md-vv-avek`). Without temperature and pressure coupling, velocity Verlet with half-step-averaged kinetic energies and leap-frog will be identical up to numerical precision. For temperature- and pressure-control schemes, however, velocity Verlet with half-step-averaged kinetic energies and leap-frog will be different, as will be discussed in the section in thermostats and barostats.

The half-step-averaged kinetic energy and temperature are slightly more accurate for a given step size; the difference in average kinetic energies using the half-step-averaged kinetic energies (`md` and `md-vv-avek`) will be closer to the kinetic energy obtained in the limit of small step size than will the full-step kinetic energy (using `md-vv`). For NVE simulations, this difference is usually not significant, since the positions and velocities of the particles are still identical; it makes a difference in the way the the temperature of the simulations are *interpreted*, but *not* in the trajectories that are produced. Although the kinetic energy is more accurate with the half-step-averaged method, meaning that it changes less as the timestep gets large, it is also more noisy. The RMS deviation of the total energy of the system (sum of kinetic plus potential) in the half-step-averaged kinetic energy case will be higher (about twice as high in most cases) than the full-step kinetic energy. The drift will still be the same, however, as again, the trajectories are identical.

For NVT simulations, however, there *will* be a difference, as discussed in the section on temperature control, since the velocities of the particles are adjusted such that kinetic energies of the simulations, which can be calculated either way, reach the distribution corresponding to the set temperature. In this case, the three methods will not give identical results.

Because the velocity and position are both defined at the same time t the velocity Verlet integrator can be used for some methods, especially rigorously correct pressure control methods, that are not actually possible with leap-frog. The integration itself takes negligibly more time than leap-frog, but twice as many communication calls are currently required. In most cases, and especially for large systems where communication speed is important for parallelization and differences between thermodynamic ensembles vanish in the $1/N$ limit, and when only NVT ensembles are required, leap-frog will likely be the preferred integrator. For pressure control simulations where the fine details of the thermodynamics are important, only velocity Verlet allows the true ensemble to be calculated. In either case, simulation with double precision may be required to get fine details of thermodynamics correct.

3.4.7 Twin-range cut-offs

To save computation time, slowly varying forces can be calculated less often than rapidly varying forces. In GROMACS such a multiple time step splitting is possible between short and long range

non-bonded interactions. In GROMACS versions up to 4.0, an irreversible integration scheme was used which is also used by the GROMOS simulation package: every n steps the long range forces are determined and these are then also used (without modification) for the next $n - 1$ integration steps in eqn. 3.25. Such an irreversible scheme can result in bad energy conservation and, possibly, bad sampling. Since version 4.5, a leap-frog version of the reversible Trotter decomposition scheme [24] is used. In this integrator the long-range forces are determined every n steps and are then integrated into the velocity in eqn. 3.25 using a time step of $\Delta t_{LR} = n\Delta t$:

$$\mathbf{v}(t + \frac{1}{2}\Delta t) = \begin{cases} \mathbf{v}(t - \frac{1}{2}\Delta t) + \frac{1}{m} [\mathbf{F}_{SR}(t) + n\mathbf{F}_{LR}(t)] \Delta t & , \text{ step \% } n = 0 \\ \mathbf{v}(t - \frac{1}{2}\Delta t) + \frac{1}{m} \mathbf{F}_{SR}(t) \Delta t & , \text{ step \% } n \neq 0 \end{cases} \quad (3.43)$$

The parameter n is equal to the neighbor list update frequency. In 4.5, the velocity Verlet version of multiple time-stepping is not yet fully implemented.

Several other simulation packages uses multiple time stepping for bonds and/or the PME mesh forces. In GROMACS we have not implemented this (yet), since we use a different philosophy. Bonds can be constrained (which is also a more sound approximation of a physical quantum oscillator), which allows the smallest time step to be increased to the larger one. This not only halves the number of force calculations, but also the update calculations. For even larger time steps, angle vibrations involving hydrogen atoms can be removed using virtual interaction sites (see sec. 6.7), which brings the shortest time step up to PME mesh update frequency of a multiple time stepping scheme.

As an example we show the energy conservation for integrating the equations of motion for SPC/E water at 300 K. To avoid cut-off effects, reaction-field electrostatics with $\epsilon_{RF} = \infty$ and shifted Lennard-Jones interactions are used, both with a buffer region. The long-range interactions were evaluated between 1.0 and 1.4 nm. In Fig. 3.7 one can see that for electrostatics the Trotter scheme does an order of magnitude better up to $\Delta t_{LR} = 16$ fs. The electrostatics depends strongly on the orientation of the water molecules, which changes rapidly. For Lennard-Jones interactions, the energy drift is linear in Δt_{LR} and roughly two orders of magnitude smaller than for the electrostatics. Lennard-Jones forces are smaller than Coulomb forces and they are mainly affected by translation of water molecules, not rotation.

3.4.8 Temperature coupling

While direct use of molecular dynamics gives rise to the NVE (constant number, constant volume, constant energy ensemble), most quantities that we wish to calculate are actually from a constant temperature (NVT) ensemble, also called the canonical ensemble. GROMACS can use the *weak-coupling* scheme of Berendsen [25], stochastic randomization through the Andersen thermostat [26], the extended ensemble Nosé-Hoover scheme [27, 28], or a velocity-rescaling scheme [29] to simulate constant temperature, with advantages of each of the schemes laid out below.

There are several other reasons why it might be necessary to control the temperature of the system (drift during equilibration, drift as a result of force truncation and integration errors, heating due to external or frictional forces), but this is not entirely correct to do from a thermodynamic standpoint,

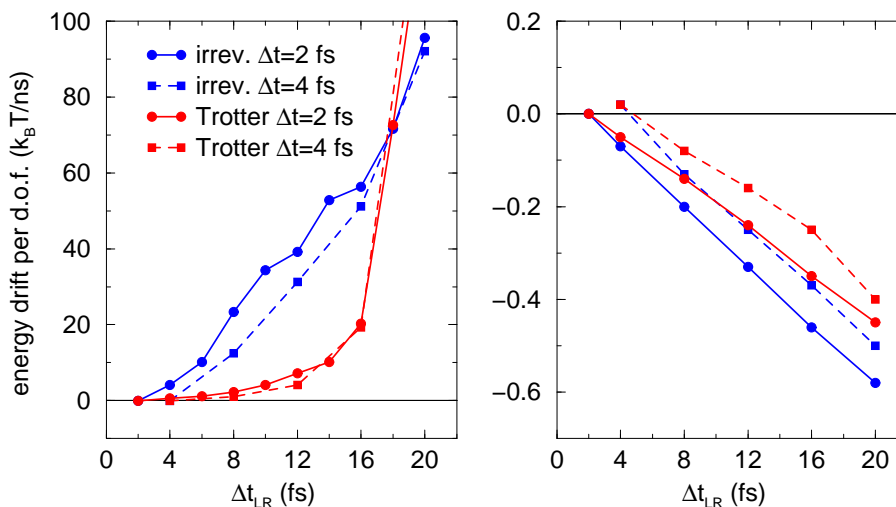

Figure 3.8: Energy drift per degree of freedom in SPC/E water with twin-range cut-offs for reaction field (left) and Lennard-Jones interaction (right) as a function of the long-range time step length for the irreversible “GROMOS” scheme and a reversible Trotter scheme.

and in some cases only masks the symptoms (increase in temperature of the system) rather than the underlying problem (deviations from correct physics in the dynamics). For larger systems, errors in ensemble averages and structural properties incurred by using temperature control to remove slow drifts in temperature appear to be negligible, but no completely comprehensive comparisons have been carried out, and some caution must be taking in interpreting the results.

Berendsen temperature coupling

The Berendsen algorithm mimics weak coupling with first-order kinetics to an external heat bath with given temperature T_0 . See ref. [30] for a comparison with the Nosé-Hoover scheme. The effect of this algorithm is that a deviation of the system temperature from T_0 is slowly corrected according to:

$$\frac{dT}{dt} = \frac{T_0 - T}{\tau} \quad (3.44)$$

which means that a temperature deviation decays exponentially with a time constant τ . This method of coupling has the advantage that the strength of the coupling can be varied and adapted to the user requirement: for equilibration purposes the coupling time can be taken quite short (*e.g.* 0.01 ps), but for reliable equilibrium runs it can be taken much longer (*e.g.* 0.5 ps) in which case it hardly influences the conservative dynamics.

The Berendsen thermostat suppresses the fluctuations of the kinetic energy. This means that one does not generate a proper canonical ensemble, so rigorously, the sampling will be incorrect. This error scales with $1/N$, so for very large systems most ensemble averages will not be affected significantly, except for the distribution of the kinetic energy itself. However, fluctuation properties, such as the heat capacity, will be affected. A similar thermostat which does produce a correct ensemble is the velocity rescaling thermostat [29] described below.

The heat flow into or out of the system is affected by scaling the velocities of each particle every step, or every n_{TC} steps, with a time-dependent factor λ , given by:

$$\lambda = \left[1 + \frac{n_{TC}\Delta t}{\tau_T} \left\{ \frac{T_0}{T(t - \frac{1}{2}\Delta t)} - 1 \right\} \right]^{1/2} \quad (3.45)$$

The parameter τ_T is close, but not exactly equal, to the time constant τ of the temperature coupling (eqn. 3.44):

$$\tau = 2C_V\tau_T/N_{df}k \quad (3.46)$$

where C_V is the total heat capacity of the system, k is Boltzmann's constant, and N_{df} is the total number of degrees of freedom. The reason that $\tau \neq \tau_T$ is that the kinetic energy change caused by scaling the velocities is partly redistributed between kinetic and potential energy and hence the change in temperature is less than the scaling energy. In practice, the ratio τ/τ_T ranges from 1 (gas) to 2 (harmonic solid) to 3 (water). When we use the term "temperature coupling time constant," we mean the parameter τ_T . **Note** that in practice the scaling factor λ is limited to the range of $0.8 \leq \lambda \leq 1.25$, to avoid scaling by very large numbers which may crash the simulation. In normal use, λ will always be much closer to 1.0.

Velocity-rescaling temperature coupling

The velocity-rescaling thermostat [29] is essentially a Berendsen thermostat (see above) with an additional stochastic term that ensures a correct kinetic energy distribution by modifying it according to

$$dK = (K_0 - K) \frac{dt}{\tau_T} + 2\sqrt{\frac{KK_0}{N_f}} \frac{dW}{\sqrt{\tau_T}}, \quad (3.47)$$

where K is the kinetic energy, N_f the number of degrees of freedom and dW a Wiener process. There are no additional parameters, except for a random seed. This thermostat produces a correct canonical ensemble and still has the advantage of the Berendsen thermostat: first order decay of temperature deviations and no oscillations. When an NVT ensemble is used, the conserved energy quantity is written to the energy and log file.

Andersen thermostat

One simple way to maintain a thermostatted ensemble is to take an NVE integrator and periodically re-select the velocities of the particles from a Maxwell-Boltzmann distribution. [26]. This can either be done by randomizing all the velocities simultaneously (massive collision) every $\tau_T/\Delta t$ steps, or by randomizing every particle with some small probability every timestep, equal to $\Delta t/\tau$, where in both cases Δt is the timestep and τ_T is a characteristic coupling time scale.

Because of the way constraints operate, all particles in the same constraint group must be re-randomized simultaneously. This thermostat is also only possible with velocity Verlet algorithms, because it operates directly on the velocities at each timestep.

This algorithm avoids some of the ergodicity issues of other algorithms, as energy cannot flow back and forth between energetically decoupled components of the system as in velocity scaling motions. However, it can slow down the kinetics of system by randomizing correlated motions

of the system, including slowing sampling when τ_T is at moderate levels (less than 10 ps). This algorithm should therefore generally not be used when examining kinetics of the system, but can avoid ergodicity problems of scaling problems when examining thermodynamic properties.

Nosé-Hoover temperature coupling

The Berendsen weak-coupling algorithm is extremely efficient for relaxing a system to the target temperature, but once the system has reached equilibrium it might be more important to probe a correct canonical ensemble. This is unfortunately not the case for the weak-coupling scheme.

To enable canonical ensemble simulations, GROMACS also supports the extended-ensemble approach first proposed by Nosé [27] and later modified by Hoover [28]. The system Hamiltonian is extended by introducing a thermal reservoir and a friction term in the equations of motion. The friction force is proportional to the product of each particle's velocity and a friction parameter, ξ . This friction parameter (or “heat bath” variable) is a fully dynamic quantity with its own momentum (p_ξ) and equation of motion; the time derivative is calculated from the difference between the current kinetic energy and the reference temperature.

In this formulation, the particles' equations of motion in Fig. 3.3 are replaced by:

$$\frac{d^2 \mathbf{r}_i}{dt^2} = \frac{\mathbf{F}_i}{m_i} - \frac{p_\xi}{Q} \frac{d\mathbf{r}_i}{dt}, \quad (3.48)$$

where the equation of motion for the heat bath parameter ξ is:

$$\frac{dp_\xi}{dt} = (T - T_0). \quad (3.49)$$

The reference temperature is denoted T_0 , while T is the current instantaneous temperature of the system. The strength of the coupling is determined by the constant Q (usually called the “mass parameter” of the reservoir) in combination with the reference temperature.¹

The conserved quantity for the Nosé-Hoover equations of motion is not the total energy, but rather

$$H = \sum_{i=1}^N \frac{\mathbf{p}_i^2}{2m_i} + U(\mathbf{r}_1, \mathbf{r}_2, \dots, \mathbf{r}_N) + \frac{p_\xi^2}{2Q} + N_f kT\xi, \quad (3.50)$$

where N_f is the total number of degrees of freedom.

In our opinion, the mass parameter is a somewhat awkward way of describing coupling strength, especially due to its dependence on reference temperature (and some implementations even include the number of degrees of freedom in your system when defining Q). To maintain the coupling strength, one would have to change Q in proportion to the change in reference temperature. For this reason, we prefer to let the GROMACS user work instead with the period τ_T of the oscillations of kinetic energy between the system and the reservoir instead. It is directly related to Q and T_0 via:

$$Q = \frac{\tau_T^2 T_0}{4\pi^2}. \quad (3.51)$$

¹Note that some derivations, an alternative notation $\xi_{\text{alt}} = v_\xi = p_\xi/Q$ is used.

This provides a much more intuitive way of selecting the Nosé-Hoover coupling strength (similar to the weak-coupling relaxation), and in addition τ_T is independent of system size and reference temperature.

It is however important to keep the difference between the weak-coupling scheme and the Nosé-Hoover algorithm in mind: Using weak coupling you get a strongly damped *exponential relaxation*, while the Nosé-Hoover approach produces an *oscillatory relaxation*. The actual time it takes to relax with Nosé-Hoover coupling is several times larger than the period of the oscillations that you select. These oscillations (in contrast to exponential relaxation) also means that the time constant normally should be 4–5 times larger than the relaxation time used with weak coupling, but your mileage may vary.

Nosé-Hoover dynamics in simple systems such as collections of harmonic oscillators, can be *non-ergodic*, meaning that only a subsection of phase space is ever sampled, even if the simulations were to run for infinitely long. For this reason, the Nosé-Hoover chain approach was developed, where each of the Nosé-Hoover thermostats has its own Nosé-Hoover thermostat controlling its temperature. In the limit of an infinite chain of thermostats, the dynamics are guaranteed to be ergodic. Using just a few chains can greatly improve the ergodicity, but recent research has shown that the system will still be nonergodic, and it is still not entirely clear what the practical effect of this [31]. Currently, the default number of chains is 10, but this can be controlled by the user. In the case of chains, the equations are modified in the following way to include a chain of thermostating particles [32]:

$$\begin{aligned}
 \frac{d^2 \mathbf{r}_i}{dt^2} &= \frac{\mathbf{F}_i}{m_i} - \frac{p_{\xi_1}}{Q_1} \frac{d\mathbf{r}_i}{dt} \\
 \frac{dp_{\xi_1}}{dt} &= (T - T_0) - p_{\xi_1} \frac{p_{\xi_2}}{Q_2} \\
 \frac{dp_{\xi_{i=2\dots N}}}{dt} &= \left(\frac{p_{\xi_{i-1}}^2}{Q_{i-1}} - kT \right) - p_{\xi_i} \frac{p_{\xi_{i+1}}}{Q_{i+1}} \\
 \frac{dp_{\xi_N}}{dt} &= \left(\frac{p_{\xi_{N-1}}^2}{Q_{N-1}} - kT \right)
 \end{aligned} \tag{3.52}$$

The conserved quantity for Nosé-Hoover chains is

$$H = \sum_{i=1}^N \frac{\mathbf{p}_i^2}{2m_i} + U(\mathbf{r}_1, \mathbf{r}_2, \dots, \mathbf{r}_N) + \sum_{k=1}^M \frac{p_{\xi_k}^2}{2Q_k'} + N_f kT \xi_1 + kT \sum_{k=2}^M \xi_k \tag{3.53}$$

The values and velocities of the Nosé-Hoover thermostat variables are generally not included in the output, as they take up a fair amount of space and are generally not important for analysis of simulations, but this can be overridden by defining the environment variable `GMX_NOSEHOVER_CHAINS`, which will print the values of all the positions and velocities of all Nosé-Hoover particles in the chain to the `.edr` file. Leap-frog simulations currently can only have Nosé-Hoover chain lengths of 1, but this will likely be updated in later version.

As described in the integrator section, for temperature coupling, the temperature that the algorithm attempts to match to the reference temperature is calculated differently in velocity Verlet and leap-frog dynamics. Velocity Verlet (*md-vv*) uses the full-step kinetic energy, while leap-frog and *md-vv-avek* use the half-step-averaged kinetic energy.

We can examine the Trotter decomposition again to better understand the differences between these constant-temperature integrators. In the case of Nosé-Hoover dynamics (for simplicity, using a chain with $N = 1$, with more details in Ref. [33]), we split the Liouville operator as

$$iL = iL_1 + iL_2 + iL_{\text{NHC}}, \quad (3.54)$$

where

$$\begin{aligned} iL_1 &= \sum_{i=1}^N \left[\frac{\mathbf{p}_i}{m_i} \right] \cdot \frac{\partial}{\partial \mathbf{r}_i} \\ iL_2 &= \sum_{i=1}^N \mathbf{F}_i \cdot \frac{\partial}{\partial \mathbf{p}_i} \\ iL_{\text{NHC}} &= \sum_{i=1}^N -\frac{p_\xi}{Q} \mathbf{v}_i \cdot \nabla_{\mathbf{v}_i} + \frac{p_\xi}{Q} \frac{\partial}{\partial \xi} + (T - T_0) \frac{\partial}{\partial p_\xi} \end{aligned} \quad (3.55)$$

For standard velocity Verlet with Nosé-Hoover temperature control, this becomes

$$\begin{aligned} \exp(iL\Delta t) &= \exp(iL_{\text{NHC}}\Delta t/2) \exp(iL_2\Delta t/2) \\ &\quad \exp(iL_1\Delta t) \exp(iL_2\Delta t/2) \exp(iL_{\text{NHC}}\Delta t/2) + \mathcal{O}(\Delta t^3). \end{aligned} \quad (3.56)$$

For half-step-averaged temperature control using *md-vv-avek*, this decomposition will not work, since we do not have the full step temperature until after the second velocity step. However, we can construct an alternate decomposition that is still reversible, by switching the place of the NHC and velocity portions of the decomposition:

$$\begin{aligned} \exp(iL\Delta t) &= \exp(iL_2\Delta t/2) \exp(iL_{\text{NHC}}\Delta t/2) \exp(iL_1\Delta t) \\ &\quad \exp(iL_{\text{NHC}}\Delta t/2) \exp(iL_2\Delta t/2) + \mathcal{O}(\Delta t^3) \end{aligned} \quad (3.57)$$

This formalism allows us to easily see the difference between the different flavors of velocity Verlet integrator. The leap-frog integrator can be seen as starting with Eq. 3.57 just before the $\exp(iL_1\Delta t)$ term, yielding:

$$\begin{aligned} \exp(iL\Delta t) &= \exp(iL_1\Delta t) \exp(iL_{\text{NHC}}\Delta t/2) \\ &\quad \exp(iL_2\Delta t) \exp(iL_{\text{NHC}}\Delta t/2) + \mathcal{O}(\Delta t^3) \end{aligned} \quad (3.58)$$

and then using some algebra tricks to solve for some quantities are required before they are actually calculated [34].

Group temperature coupling

In GROMACS temperature coupling can be performed on groups of atoms, typically a protein and solvent. The reason such algorithms were introduced is that energy exchange between different components is not perfect, due to different effects including cut-offs etc. If now the whole system is coupled to one heat bath, water (which experiences the largest cut-off noise) will tend to heat up and the protein will cool down. Typically 100 K differences can be obtained. With the use of proper electrostatic methods (PME) these difference are much smaller but still not negligible. The

parameters for temperature coupling in groups are given in the `mcp` file. Recent investigation has shown that small temperature differences between protein and water may actually be an artifact of the way temperature is calculated when there are finite timesteps, and very large differences in temperature are likely a sign of something else seriously going wrong with the system, and should be investigated carefully [35].

One special case should be mentioned: it is possible to temperature-couple only part of the system, leaving other parts without temperature coupling. This is done by specifying -1 for the time constant τ_T for the group that should not be thermostatted. If only part of the system is thermostatted, the system will still eventually converge to an NVT system. In fact, one suggestion for minimizing errors in the temperature caused by discretized timesteps is that if constraints on the water are used, then only the water degrees of freedom should be thermostatted, not protein degrees of freedom, as the higher frequency modes in the protein can cause larger deviations from the “true” temperature, the temperature obtained with small timesteps [35].

3.4.9 Pressure coupling

In the same spirit as the temperature coupling, the system can also be coupled to a “pressure bath.” GROMACS supports both the Berendsen algorithm [25] that scales coordinates and box vectors every step, the extended-ensemble Parrinello-Rahman approach [36, 37], and for the velocity Verlet variants, the Martyna-Tuckerman-Tobias-Klein (MTTK) implementation of pressure control [33]. Parrinello-Rahman and Berendsen can be combined with any of the temperature coupling methods above; MTTK can only be used with Nosé-Hoover temperature control.

Berendsen pressure coupling

The Berendsen algorithm rescales the coordinates and box vectors every step, or every n_{PC} steps, with a matrix μ , which has the effect of a first-order kinetic relaxation of the pressure towards a given reference pressure P_0 according to

$$\frac{d\mathbf{P}}{dt} = \frac{\mathbf{P}_0 - \mathbf{P}}{\tau_p}. \quad (3.59)$$

The scaling matrix μ is given by

$$\mu_{ij} = \delta_{ij} - \frac{n_{PC}\Delta t}{3\tau_p}\beta_{ij}\{P_{0ij} - P_{ij}(t)\}. \quad (3.60)$$

Here, β is the isothermal compressibility of the system. In most cases this will be a diagonal matrix, with equal elements on the diagonal, the value of which is generally not known. It suffices to take a rough estimate because the value of β only influences the non-critical time constant of the pressure relaxation without affecting the average pressure itself. For water at 1 atm and 300 K $\beta = 4.6 \times 10^{-10} \text{ Pa}^{-1} = 4.6 \times 10^{-5} \text{ bar}^{-1}$, which is 7.6×10^{-4} MD units (see chapter 2). Most other liquids have similar values. When scaling completely anisotropically, the system has to be rotated in order to obey eqn. 3.1. This rotation is approximated in first order in the scaling, which

is usually less than 10^{-4} . The actual scaling matrix $\boldsymbol{\mu}'$ is

$$\boldsymbol{\mu}' = \begin{pmatrix} \mu_{xx} & \mu_{xy} + \mu_{yx} & \mu_{xz} + \mu_{zx} \\ 0 & \mu_{yy} & \mu_{yz} + \mu_{zy} \\ 0 & 0 & \mu_{zz} \end{pmatrix}. \quad (3.61)$$

The velocities are neither scaled nor rotated.

In GROMACS, the Berendsen scaling can also be done isotropically, which means that instead of \boldsymbol{P} a diagonal matrix with elements of size $\text{trace}(\boldsymbol{P})/3$ is used. For systems with interfaces, semi-isotropic scaling can be useful. In this case, the x/y -directions are scaled isotropically and the z direction is scaled independently. The compressibility in the x/y or z -direction can be set to zero, to scale only in the other direction(s).

If you allow full anisotropic deformations and use constraints you might have to scale more slowly or decrease your timestep to avoid errors from the constraint algorithms. It is important to note that although the Berendsen pressure control algorithm yields a simulation with the correct average pressure, it does not yield the exact NPT ensemble, and it is not yet clear exactly what errors this approximation may yield.

Parrinello-Rahman pressure coupling

In cases where the fluctuations in pressure or volume are important *per se* (e.g. to calculate thermodynamic properties), especially for small systems, it may be a problem that the exact ensemble is not well defined for the weak-coupling scheme, and that it does not simulate the true NPT ensemble.

GROMACS also supports constant-pressure simulations using the Parrinello-Rahman approach [36, 37], which is similar to the Nosé-Hoover temperature coupling, and in theory gives the true NPT ensemble. With the Parrinello-Rahman barostat, the box vectors as represented by the matrix \boldsymbol{b} obey the matrix equation of motion²

$$\frac{d\boldsymbol{b}^2}{dt^2} = V\boldsymbol{W}^{-1}\boldsymbol{b}'^{-1}(\boldsymbol{P} - \boldsymbol{P}_{ref}). \quad (3.62)$$

The volume of the box is denoted V , and \boldsymbol{W} is a matrix parameter that determines the strength of the coupling. The matrices \boldsymbol{P} and \boldsymbol{P}_{ref} are the current and reference pressures, respectively.

The equations of motion for the particles are also changed, just as for the Nosé-Hoover coupling. In most cases you would combine the Parrinello-Rahman barostat with the Nosé-Hoover thermostat, but to keep it simple we only show the Parrinello-Rahman modification here:

$$\frac{d^2\boldsymbol{r}_i}{dt^2} = \frac{\boldsymbol{F}_i}{m_i} - \boldsymbol{M}\frac{d\boldsymbol{r}_i}{dt}, \quad (3.63)$$

$$\boldsymbol{M} = \boldsymbol{b}^{-1} \left[\boldsymbol{b}\frac{d\boldsymbol{b}'}{dt} + \frac{d\boldsymbol{b}}{dt}\boldsymbol{b}' \right] \boldsymbol{b}'^{-1}. \quad (3.64)$$

²The box matrix representation \boldsymbol{b} in GROMACS corresponds to the transpose of the box matrix representation \boldsymbol{h} in the paper by Nosé and Klein. Because of this, some of our equations will look slightly different.

The (inverse) mass parameter matrix \mathbf{W}^{-1} determines the strength of the coupling, and how the box can be deformed. The box restriction (3.1) will be fulfilled automatically if the corresponding elements of \mathbf{W}^{-1} are zero. Since the coupling strength also depends on the size of your box, we prefer to calculate it automatically in GROMACS. You only have to provide the approximate isothermal compressibilities β and the pressure time constant τ_p in the input file (L is the largest box matrix element):

$$\left(\mathbf{W}^{-1}\right)_{ij} = \frac{4\pi^2\beta_{ij}}{3\tau_p^2 L}. \quad (3.65)$$

Just as for the Nosé-Hoover thermostat, you should realize that the Parrinello-Rahman time constant is *not* equivalent to the relaxation time used in the Berendsen pressure coupling algorithm. In most cases you will need to use a 4–5 times larger time constant with Parrinello-Rahman coupling. If your pressure is very far from equilibrium, the Parrinello-Rahman coupling may result in very large box oscillations that could even crash your run. In that case you would have to increase the time constant, or (better) use the weak-coupling scheme to reach the target pressure, and then switch to Parrinello-Rahman coupling once the system is in equilibrium. Additionally, using the leap-frog algorithm, the pressure at time t is not available until after the time step has completed, and so the pressure from the previous step must be used, which makes the algorithm not directly reversible, and may not be appropriate for high precision thermodynamic calculations.

Surface-tension coupling

When a periodic system consists of more than one phase, separated by surfaces which are parallel to the xy -plane, the surface tension and the z -component of the pressure can be coupled to a pressure bath. Presently, this only works with the Berendsen pressure coupling algorithm in GROMACS. The average surface tension $\gamma(t)$ can be calculated from the difference between the normal and the lateral pressure

$$\gamma(t) = \frac{1}{n} \int_0^{L_z} \left\{ P_{zz}(z, t) - \frac{P_{xx}(z, t) + P_{yy}(z, t)}{2} \right\} dz \quad (3.66)$$

$$= \frac{L_z}{n} \left\{ P_{zz}(t) - \frac{P_{xx}(t) + P_{yy}(t)}{2} \right\}, \quad (3.67)$$

where L_z is the height of the box and n is the number of surfaces. The pressure in the z -direction is corrected by scaling the height of the box with μ_z

$$\Delta P_{zz} = \frac{\Delta t}{\tau_p} \{ P_{0zz} - P_{zz}(t) \} \quad (3.68)$$

$$\mu_{zz} = 1 + \beta_{zz} \Delta P_{zz} \quad (3.69)$$

This is similar to normal pressure coupling, except that the power of 1/3 is missing. The pressure correction in the z -direction is then used to get the correct convergence for the surface tension to the reference value γ_0 . The correction factor for the box length in the x/y -direction is

$$\mu_{x/y} = 1 + \frac{\Delta t}{2\tau_p} \beta_{x/y} \left(\frac{n\gamma_0}{\mu_{zz}L_z} - \left\{ P_{zz}(t) + \Delta P_{zz} - \frac{P_{xx}(t) + P_{yy}(t)}{2} \right\} \right) \quad (3.70)$$

The value of β_{zz} is more critical than with normal pressure coupling. Normally an incorrect compressibility will just scale τ_p , but with surface tension coupling it affects the convergence of

the surface tension. When β_{zz} is set to zero (constant box height), ΔP_z is also set to zero, which is necessary for obtaining the correct surface tension.

MTTK pressure control algorithms

As mentioned in the previous section, one weakness of leap-frog integration is in constant pressure simulations, since the pressure requires a calculation of both the virial and the kinetic energy at the full time step; for leap-frog, this information is not available until *after* the full timestep. Velocity Verlet does allow the calculation, at the cost of an extra round of global communication, and can compute, mod any integration errors, the true NPT ensemble.

The full equations, combining both pressure coupling and temperature coupling, are taken from Martyna *et al.* [33] and Tuckerman [38] and are referred to here as MTTK equations (Martyna-Tuckerman-Tobias-Klein). We introduce for convenience $\epsilon = (1/3) \ln(V/V_0)$, where V_0 is a reference volume. The momentum of ϵ is $v_\epsilon = p_\epsilon/W = \dot{\epsilon} = \dot{V}/3V$, and define $\alpha = 1 + 3/N_{dof}$ (see Ref [38])

The isobaric equations are

$$\begin{aligned}\dot{\mathbf{r}}_i &= \frac{\mathbf{p}_i}{m_i} + \frac{p_\epsilon}{W} \mathbf{r}_i \\ \frac{\dot{\mathbf{p}}_i}{m_i} &= \frac{1}{m_i} \mathbf{F}_i - \alpha \frac{p_\epsilon}{W} \frac{\mathbf{p}_i}{m_i} \\ \dot{\epsilon} &= \frac{p_\epsilon}{W} \\ \frac{\dot{p}_\epsilon}{W} &= \frac{3V}{W} (P_{\text{int}} - P) + (\alpha - 1) \left(\sum_{n=1}^N \frac{\mathbf{p}_i^2}{m_i} \right),\end{aligned}\tag{3.71}$$

$$\tag{3.72}$$

where

$$P_{\text{int}} = P_{\text{kin}} - P_{\text{vir}} = \frac{1}{3V} \left[\sum_{i=1}^N \left(\frac{\mathbf{p}_i^2}{2m_i} - \mathbf{r}_i \cdot \mathbf{F}_i \right) \right].\tag{3.73}$$

The terms including α are required to make phase space incompressible [38]. The ϵ acceleration term can be rewritten as

$$\frac{\dot{p}_\epsilon}{W} = \frac{3V}{W} (\alpha P_{\text{kin}} - P_{\text{vir}} - P)\tag{3.74}$$

In terms of velocities, these equations become

$$\begin{aligned}\dot{\mathbf{r}}_i &= \mathbf{v}_i + v_\epsilon \mathbf{r}_i \\ \dot{\mathbf{v}}_i &= \frac{1}{m_i} \mathbf{F}_i - \alpha v_\epsilon \mathbf{v}_i \\ \dot{\epsilon} &= v_\epsilon \\ \dot{v}_\epsilon &= \frac{3V}{W} (P_{\text{int}} - P) + (\alpha - 1) \left(\sum_{n=1}^N \frac{1}{2} m_i \mathbf{v}_i^2 \right) \\ P_{\text{int}} &= P_{\text{kin}} - P_{\text{vir}} = \frac{1}{3V} \left[\sum_{i=1}^N \left(\frac{1}{2} m_i \mathbf{v}_i^2 - \mathbf{r}_i \cdot \mathbf{F}_i \right) \right]\end{aligned}\tag{3.75}$$

For these equations, the conserved quantity is

$$H = \sum_{i=1}^N \frac{\mathbf{p}_i^2}{2m_i} + U(\mathbf{r}_1, \mathbf{r}_2, \dots, \mathbf{r}_N) + \frac{p_\epsilon}{2W} + PV \quad (3.76)$$

The next step is to add temperature control. Adding Nosé-Hoover chains, including to the barostat degree of freedom, where we use η for the barostat Nosé-Hoover variables, and Q' for the coupling constants of the thermostats of the barostats, we get

$$\begin{aligned} \dot{\mathbf{r}}_i &= \frac{\mathbf{p}_i}{m_i} + \frac{p_\epsilon}{W} \mathbf{r}_i \\ \frac{\dot{\mathbf{p}}_i}{m_i} &= \frac{1}{m_i} \mathbf{F}_i - \alpha \frac{p_\epsilon}{W} \frac{\mathbf{p}_i}{m_i} - \frac{p_{\xi_1}}{Q_1} \frac{\mathbf{p}_i}{m_i} \\ \dot{\epsilon} &= \frac{p_\epsilon}{W} \\ \frac{\dot{p}_\epsilon}{W} &= \frac{3V}{W} (\alpha P_{\text{kin}} - P_{\text{vir}} - P) - \frac{p_{\eta_1}}{Q'_1} p_\epsilon \\ \dot{\xi}_k &= \frac{p_{\xi_k}}{Q_k} \\ \dot{\eta}_k &= \frac{p_{\eta_k}}{Q'_k} \\ \dot{p}_{\xi_k} &= G_k - \frac{p_{\xi_{k+1}}}{Q_{k+1}} \quad k = 1, \dots, M-1 \\ \dot{p}_{\eta_k} &= G'_k - \frac{p_{\eta_{k+1}}}{Q'_{k+1}} \quad k = 1, \dots, M-1 \\ \dot{p}_{\xi_M} &= G_M \\ \dot{p}_{\eta_M} &= G'_M, \end{aligned} \quad (3.77)$$

where

$$\begin{aligned} P_{\text{int}} &= P_{\text{kin}} - P_{\text{vir}} = \frac{1}{3V} \left[\sum_{i=1}^N \left(\frac{\mathbf{p}_i^2}{2m_i} - \mathbf{r}_i \cdot \mathbf{F}_i \right) \right] \\ G_1 &= \sum_{i=1}^N \frac{\mathbf{p}_i^2}{m_i} - N_f kT \\ G_k &= \frac{p_{\xi_{k-1}}^2}{2Q_{k-1}} - kT \quad k = 2, \dots, M \\ G'_1 &= \frac{p_\epsilon^2}{2W} - kT \\ G'_k &= \frac{p_{\eta_{k-1}}^2}{2Q'_{k-1}} - kT \quad k = 2, \dots, M \end{aligned} \quad (3.78)$$

The conserved quantity is now

$$H = \sum_{i=1}^N \frac{\mathbf{p}_i}{2m_i} + U(\mathbf{r}_1, \mathbf{r}_2, \dots, \mathbf{r}_N) + \frac{p_\epsilon^2}{2W} + PV +$$

$$\sum_{k=1}^M \frac{p_{\xi_k}^2}{2Q_k} + \sum_{k=1}^M \frac{p_{\eta_k}^2}{2Q'_k} + N_f kT \xi_1 + kT \sum_{i=2}^M \xi_k + kT \sum_{k=1}^M \eta_k \quad (3.79)$$

Returning to the Trotter decomposition formalism, for pressure control and temperature control [33] we get:

$$iL = iL_1 + iL_2 + iL_{\epsilon,1} + iL_{\epsilon,2} + iL_{\text{NHC-baro}} + iL_{\text{NHC}} \quad (3.80)$$

where “NHC-baro” corresponds to the Nosè-Hoover chain of the barostat, and NHC corresponds to the NHC of the particles,

$$iL_1 = \sum_{i=1}^N \left[\frac{\mathbf{p}_i}{m_i} + \frac{p_\epsilon}{W} \mathbf{r}_i \right] \cdot \frac{\partial}{\partial \mathbf{r}_i} \quad (3.81)$$

$$iL_2 = \sum_{i=1}^N \mathbf{F}_i - \alpha \frac{p_\epsilon}{W} \mathbf{p}_i \cdot \frac{\partial}{\partial \mathbf{p}_i} \quad (3.82)$$

$$iL_{\epsilon,1} = \frac{p_\epsilon}{W} \frac{\partial}{\partial \epsilon} \quad (3.83)$$

$$iL_{\epsilon,2} = G_\epsilon \frac{\partial}{\partial p_\epsilon} \quad (3.84)$$

and where

$$G_\epsilon = 3V (\alpha P_{\text{kin}} - P_{\text{vir}} - P) \quad (3.85)$$

Using the Trotter decomposition, we get

$$\begin{aligned} \exp(iL\Delta t) &= \exp(iL_{\text{NHC-baro}}\Delta t/2) \exp(iL_{\text{NHC}}\Delta t/2) \\ &\exp(iL_{\epsilon,2}\Delta t/2) \exp(iL_2\Delta t/2) \\ &\exp(iL_{\epsilon,1}\Delta t) \exp(iL_1\Delta t) \\ &\exp(iL_2\Delta t/2) \exp(iL_{\epsilon,2}\Delta t/2) \\ &\exp(iL_{\text{NHC}}\Delta t/2) \exp(iL_{\text{NHC-baro}}\Delta t/2) + \mathcal{O}(\Delta t^3) \end{aligned} \quad (3.86)$$

The action of $\exp(iL_1\Delta t)$ comes from the solution of the the differential equation $\dot{\mathbf{r}}_i = \mathbf{v}_i + v_\epsilon \mathbf{r}_i$ with $\mathbf{v}_i = \mathbf{p}_i/m_i$ and v_ϵ constant with initial condition $\mathbf{r}_i(0)$, evaluate at $t = \Delta t$. This yields the evolution

$$\mathbf{r}_i(\Delta t) = \mathbf{r}_i(0)e^{v_\epsilon \Delta t} + \Delta t \mathbf{v}_i(0)e^{v_\epsilon \Delta t/2} \frac{\sinh(v_\epsilon \Delta t/2)}{v_\epsilon \Delta t/2}. \quad (3.87)$$

The action of $\exp(iL_2\Delta t/2)$ comes from the solution of the differential equation $\dot{\mathbf{v}}_i = \frac{\mathbf{F}_i}{m_i} - \alpha v_\epsilon \mathbf{v}_i$, yielding

$$\mathbf{v}_i(\Delta t/2) = \mathbf{v}_i(0)e^{-\alpha v_\epsilon \Delta t/2} + \frac{\Delta t}{2m_i} \mathbf{F}_i(0)e^{-\alpha v_\epsilon \Delta t/4} \frac{\sinh(\alpha v_\epsilon \Delta t/4)}{\alpha v_\epsilon \Delta t/4}. \quad (3.88)$$

md-vv-avek uses the full step kinetic energies for determining the pressure with the pressure control, but the half-step-averaged kinetic energy for the temperatures, which can be written as a Trotter decomposition as

$$\begin{aligned} \exp(iL\Delta t) &= \exp(iL_{\text{NHC-baro}}\Delta t/2) \exp(iL_{\epsilon,2}\Delta t/2) \exp(iL_2\Delta t/2) \\ &\exp(iL_{\text{NHC}}\Delta t/2) \exp(iL_{\epsilon,1}\Delta t) \exp(iL_1\Delta t) \exp(iL_{\text{NHC}}\Delta t/2) \\ &\exp(iL_2\Delta t/2) \exp(iL_{\epsilon,2}\Delta t/2) \exp(iL_{\text{NHC-baro}}\Delta t/2) + \mathcal{O}(\Delta t^3) \end{aligned} \quad (3.89)$$

With constraints, the equations become significantly more complicated, in that each of these equations need to be solved iteratively for the constraint forces. The discussion of the details of the iteration is beyond the scope of this manual; readers are encouraged to see the implementation described in [39].

Infrequent evaluation of temperature and pressure coupling

Temperature and pressure control require global communication to compute the kinetic energy and virial, which can become costly if performed every step for large systems. We can rearrange the Trotter decomposition to give alternate symplectic, reversible integrator with the coupling steps every n steps instead of every steps. These new integrators will diverge if the coupling time step is too large, as the auxiliary variable integrations will not converge. However, in most cases, long coupling times are more appropriate, as they disturb the dynamics less [33].

Standard velocity Verlet with Nosé-Hoover temperature control has a Trotter expansion

$$\exp(iL\Delta t) \approx \exp(iL_{\text{NHC}}\Delta t/2) \exp(iL_2\Delta t/2) \exp(iL_1\Delta t) \exp(iL_2\Delta t/2) \exp(iL_{\text{NHC}}\Delta t/2). \quad (3.90)$$

If the Nosé-Hoover chain is sufficiently slow with respect to the motions of the system, we can write an alternate integrator over n steps for velocity Verlet as

$$\exp(iL\Delta t) \approx (\exp(iL_{\text{NHC}}(n\Delta t/2)) [\exp(iL_2\Delta t/2) \exp(iL_1\Delta t) \exp(iL_2\Delta t/2)]^n \exp(iL_{\text{NHC}}(n\Delta t/2))). \quad (3.91)$$

For pressure control, this becomes

$$\begin{aligned} \exp(iL\Delta t) \approx & \exp(iL_{\text{NHC-baro}}(n\Delta t/2)) \exp(iL_{\text{NHC}}(n\Delta t/2)) \\ & \exp(iL_{\epsilon,2}(n\Delta t/2)) [\exp(iL_2\Delta t/2) \\ & \exp(iL_{\epsilon,1}\Delta t) \exp(iL_1\Delta t) \\ & \exp(iL_2\Delta t/2)]^n \exp(iL_{\epsilon,2}(n\Delta t/2)) \\ & \exp(iL_{\text{NHC}}(n\Delta t/2)) \exp(iL_{\text{NHC-baro}}(n\Delta t/2)), \end{aligned} \quad (3.92)$$

where the box volume integration occurs every step, but the auxiliary variable integrations happen every n steps.

3.4.10 The complete update algorithm

The complete algorithm for the update of velocities and coordinates is given using leap-frog in Fig. 3.9. The SHAKE algorithm of step 4 is explained below.

GROMACS has a provision to “freeze” (prevent motion of) selected particles, which must be defined as a “freeze group.” This is implemented using a *freeze factor* \mathbf{f}_g , which is a vector, and differs for each freeze group (see sec. 3.3). This vector contains only zero (freeze) or one (don’t freeze). When we take this freeze factor and the external acceleration \mathbf{a}_h into account the update algorithm for the velocities becomes

$$\mathbf{v}(t + \frac{\Delta t}{2}) = \mathbf{f}_g * \lambda * \left[\mathbf{v}(t - \frac{\Delta t}{2}) + \frac{\mathbf{F}(t)}{m} \Delta t + \mathbf{a}_h \Delta t \right], \quad (3.93)$$

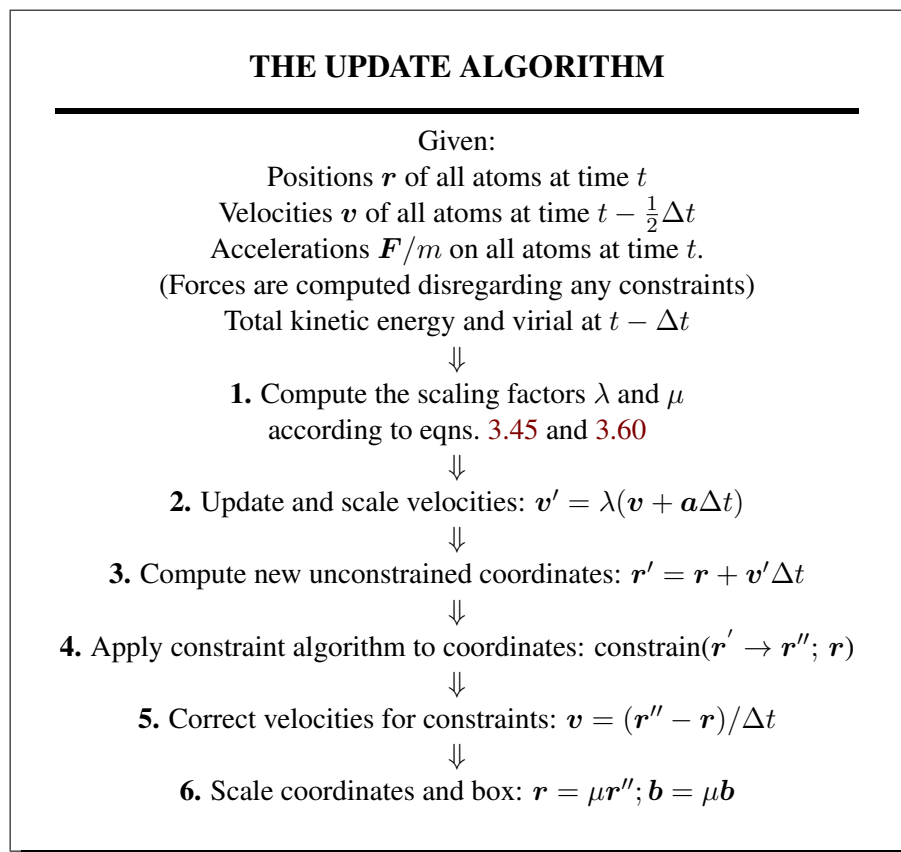

Figure 3.9: The MD update algorithm with the leap-frog integrator

where g and h are group indices which differ per atom.

3.4.11 Output step

The most important output of the MD run is the *trajectory file*, which contains particle coordinates and (optionally) velocities at regular intervals. The trajectory file contains frames that could include positions, velocities and/or forces, as well as information about the dimensions of the simulation volume, integration step, integration time, etc. The interpretation of the time varies with the integrator chosen, as described above. For velocity-Verlet integrators, velocities labeled at time t are for that time. For other integrators (e.g. leap-frog, stochastic dynamics), the velocities labeled at time t are for time $t - \frac{1}{2}\Delta t$.

Since the trajectory files are lengthy, one should not save every step! To retain all information it suffices to write a frame every 15 steps, since at least 30 steps are made per period of the highest frequency in the system, and Shannon's sampling theorem states that two samples per period of the highest frequency in a band-limited signal contain all available information. But that still gives very long files! So, if the highest frequencies are not of interest, 10 or 20 samples per ps may suffice. Be aware of the distortion of high-frequency motions by the *stroboscopic effect*, called *aliasing*: higher frequencies are mirrored with respect to the sampling frequency and appear as lower frequencies.

GROMACS can also write reduced-precision coordinates for a subset of the simulation system to a special compressed trajectory file format. All the other tools can read and write this format. See sec. 7.3 for details on how to set up your `.mdp` file to have `mdrun` use this feature.

3.5 Shell molecular dynamics

GROMACS can simulate polarizability using the shell model of Dick and Overhauser [40]. In such models a shell particle representing the electronic degrees of freedom is attached to a nucleus by a spring. The potential energy is minimized with respect to the shell position at every step of the simulation (see below). Successful applications of shell models in GROMACS have been published for N_2 [41] and water [42].

3.5.1 Optimization of the shell positions

The force \mathbf{F}_S on a shell particle S can be decomposed into two components

$$\mathbf{F}_S = \mathbf{F}_{bond} + \mathbf{F}_{nb} \quad (3.94)$$

where \mathbf{F}_{bond} denotes the component representing the polarization energy, usually represented by a harmonic potential and \mathbf{F}_{nb} is the sum of Coulomb and van der Waals interactions. If we assume that \mathbf{F}_{nb} is almost constant we can analytically derive the optimal position of the shell, i.e. where $\mathbf{F}_S = 0$. If we have the shell S connected to atom A we have

$$\mathbf{F}_{bond} = k_b (\mathbf{x}_S - \mathbf{x}_A). \quad (3.95)$$

In an iterative solver, we have positions $\mathbf{x}_S(n)$ where n is the iteration count. We now have at iteration n

$$\mathbf{F}_{nb} = \mathbf{F}_S - k_b (\mathbf{x}_S(n) - \mathbf{x}_A) \quad (3.96)$$

and the optimal position for the shells $\mathbf{x}_S(n+1)$ thus follows from

$$\mathbf{F}_S - k_b (\mathbf{x}_S(n) - \mathbf{x}_A) + k_b (\mathbf{x}_S(n+1) - \mathbf{x}_A) = 0 \quad (3.97)$$

if we write

$$\Delta \mathbf{x}_S = \mathbf{x}_S(n+1) - \mathbf{x}_S(n) \quad (3.98)$$

we finally obtain

$$\Delta \mathbf{x}_S = \mathbf{F}_S / k_b \quad (3.99)$$

which then yields the algorithm to compute the next trial in the optimization of shell positions

$$\mathbf{x}_S(n+1) = \mathbf{x}_S(n) + \mathbf{F}_S / k_b. \quad (3.100)$$

3.6 Constraint algorithms

Constraints can be imposed in GROMACS using LINCS (default) or the traditional SHAKE method.

3.6.1 SHAKE

The SHAKE [43] algorithm changes a set of unconstrained coordinates \mathbf{r}' to a set of coordinates \mathbf{r}'' that fulfill a list of distance constraints, using a set \mathbf{r} reference, as

$$\text{SHAKE}(\mathbf{r}' \rightarrow \mathbf{r}''; \mathbf{r}) \quad (3.101)$$

This action is consistent with solving a set of Lagrange multipliers in the constrained equations of motion. SHAKE needs a *relative tolerance*; it will continue until all constraints are satisfied within that relative tolerance. An error message is given if SHAKE cannot reset the coordinates because the deviation is too large, or if a given number of iterations is surpassed.

Assume the equations of motion must fulfill K holonomic constraints, expressed as

$$\sigma_k(\mathbf{r}_1 \dots \mathbf{r}_N) = 0; \quad k = 1 \dots K. \quad (3.102)$$

For example, $(\mathbf{r}_1 - \mathbf{r}_2)^2 - b^2 = 0$. Then the forces are defined as

$$-\frac{\partial}{\partial \mathbf{r}_i} \left(V + \sum_{k=1}^K \lambda_k \sigma_k \right), \quad (3.103)$$

where λ_k are Lagrange multipliers which must be solved to fulfill the constraint equations. The second part of this sum determines the *constraint forces* \mathbf{G}_i , defined by

$$\mathbf{G}_i = - \sum_{k=1}^K \lambda_k \frac{\partial \sigma_k}{\partial \mathbf{r}_i} \quad (3.104)$$

The displacement due to the constraint forces in the leap-frog or Verlet algorithm is equal to $(\mathbf{G}_i/m_i)(\Delta t)^2$. Solving the Lagrange multipliers (and hence the displacements) requires the solution of a set of coupled equations of the second degree. These are solved iteratively by SHAKE. For the special case of rigid water molecules, that often make up more than 80% of the simulation system we have implemented the SETTLE algorithm [44] (sec. 5.5).

For velocity Verlet, an additional round of constraining must be done, to constrain the velocities of the second velocity half step, removing any component of the velocity parallel to the bond vector. This step is called RATTLE, and is covered in more detail in the original Andersen paper [45].

3.6.2 LINCS

The LINCS algorithm

LINCS is an algorithm that resets bonds to their correct lengths after an unconstrained update [46]. The method is non-iterative, as it always uses two steps. Although LINCS is based on matrices, no matrix-matrix multiplications are needed. The method is more stable and faster than SHAKE, but it can only be used with bond constraints and isolated angle constraints, such as the proton angle in OH. Because of its stability, LINCS is especially useful for Brownian dynamics. LINCS has two parameters, which are explained in the subsection parameters. The parallel version of LINCS, P-LINCS, is described in subsection 3.18.3.

The LINCS formulas

We consider a system of N particles, with positions given by a $3N$ vector $\mathbf{r}(t)$. For molecular dynamics the equations of motion are given by Newton's Law

$$\frac{d^2\mathbf{r}}{dt^2} = \mathbf{M}^{-1}\mathbf{F}, \quad (3.105)$$

where \mathbf{F} is the $3N$ force vector and \mathbf{M} is a $3N \times 3N$ diagonal matrix, containing the masses of the particles. The system is constrained by K time-independent constraint equations

$$g_i(\mathbf{r}) = |\mathbf{r}_{i_1} - \mathbf{r}_{i_2}| - d_i = 0 \quad i = 1, \dots, K. \quad (3.106)$$

In a numerical integration scheme, LINCS is applied after an unconstrained update, just like SHAKE. The algorithm works in two steps (see figure Fig. 3.10). In the first step, the projections of the new bonds on the old bonds are set to zero. In the second step, a correction is applied for the lengthening of the bonds due to rotation. The numerics for the first step and the second step are very similar. A complete derivation of the algorithm can be found in [46]. Only a short description of the first step is given here.

A new notation is introduced for the gradient matrix of the constraint equations which appears on the right hand side of this equation:

$$B_{hi} = \frac{\partial g_h}{\partial r_i} \quad (3.107)$$

Notice that \mathbf{B} is a $K \times 3N$ matrix, it contains the directions of the constraints. The following equation shows how the new constrained coordinates \mathbf{r}_{n+1} are related to the unconstrained coordinates

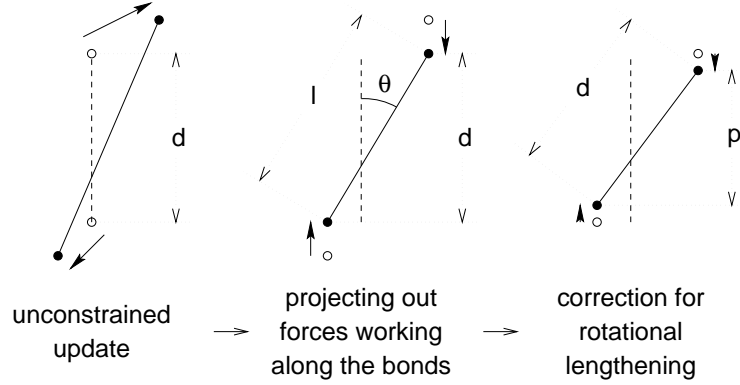

Figure 3.10: The three position updates needed for one time step. The dashed line is the old bond of length d , the solid lines are the new bonds. $l = d \cos \theta$ and $p = (2d^2 - l^2)^{\frac{1}{2}}$.

\mathbf{r}_{n+1}^{unc} by

$$\begin{aligned} \mathbf{r}_{n+1} &= (\mathbf{I} - \mathbf{T}_n \mathbf{B}_n) \mathbf{r}_{n+1}^{unc} + \mathbf{T}_n \mathbf{d} = \\ &= \mathbf{r}_{n+1}^{unc} - \mathbf{M}^{-1} \mathbf{B}_n (\mathbf{B}_n \mathbf{M}^{-1} \mathbf{B}_n^T)^{-1} (\mathbf{B}_n \mathbf{r}_{n+1}^{unc} - \mathbf{d}) \end{aligned} \quad (3.108)$$

where $\mathbf{T} = \mathbf{M}^{-1} \mathbf{B}^T (\mathbf{B} \mathbf{M}^{-1} \mathbf{B}^T)^{-1}$. The derivation of this equation from eqns. 3.105 and 3.106 can be found in [46].

This first step does not set the real bond lengths to the prescribed lengths, but the projection of the new bonds onto the old directions of the bonds. To correct for the rotation of bond i , the projection of the bond, p_i , on the old direction is set to

$$p_i = \sqrt{2d_i^2 - l_i^2}, \quad (3.109)$$

where l_i is the bond length after the first projection. The corrected positions are

$$\mathbf{r}_{n+1}^* = (\mathbf{I} - \mathbf{T}_n \mathbf{B}_n) \mathbf{r}_{n+1} + \mathbf{T}_n \mathbf{p}. \quad (3.110)$$

This correction for rotational effects is actually an iterative process, but during MD only one iteration is applied. The relative constraint deviation after this procedure will be less than 0.0001 for every constraint. In energy minimization, this might not be accurate enough, so the number of iterations is equal to the order of the expansion (see below).

Half of the CPU time goes to inverting the constraint coupling matrix $\mathbf{B}_n \mathbf{M}^{-1} \mathbf{B}_n^T$, which has to be done every time step. This $K \times K$ matrix has $1/m_{i_1} + 1/m_{i_2}$ on the diagonal. The off-diagonal elements are only non-zero when two bonds are connected, then the element is $\cos \phi / m_c$, where m_c is the mass of the atom connecting the two bonds and ϕ is the angle between the bonds.

The matrix \mathbf{T} is inverted through a power expansion. A $K \times K$ matrix \mathbf{S} is introduced which is the inverse square root of the diagonal of $\mathbf{B}_n \mathbf{M}^{-1} \mathbf{B}_n^T$. This matrix is used to convert the diagonal elements of the coupling matrix to one:

$$\begin{aligned} (\mathbf{B}_n \mathbf{M}^{-1} \mathbf{B}_n^T)^{-1} &= \mathbf{S} \mathbf{S}^{-1} (\mathbf{B}_n \mathbf{M}^{-1} \mathbf{B}_n^T)^{-1} \mathbf{S}^{-1} \mathbf{S} \\ &= \mathbf{S} (\mathbf{S} \mathbf{B}_n \mathbf{M}^{-1} \mathbf{B}_n^T \mathbf{S})^{-1} \mathbf{S} = \mathbf{S} (\mathbf{I} - \mathbf{A}_n)^{-1} \mathbf{S} \end{aligned} \quad (3.111)$$

The matrix \mathbf{A}_n is symmetric and sparse and has zeros on the diagonal. Thus a simple trick can be used to calculate the inverse:

$$(\mathbf{I} - \mathbf{A}_n)^{-1} = \mathbf{I} + \mathbf{A}_n + \mathbf{A}_n^2 + \mathbf{A}_n^3 + \dots \quad (3.112)$$

This inversion method is only valid if the absolute values of all the eigenvalues of \mathbf{A}_n are smaller than one. In molecules with only bond constraints, the connectivity is so low that this will always be true, even if ring structures are present. Problems can arise in angle-constrained molecules. By constraining angles with additional distance constraints, multiple small ring structures are introduced. This gives a high connectivity, leading to large eigenvalues. Therefore LINCS should NOT be used with coupled angle-constraints.

For molecules with all bonds constrained the eigenvalues of \mathbf{A} are around 0.4. This means that with each additional order in the expansion eqn. 3.112 the deviations decrease by a factor 0.4. But for relatively isolated triangles of constraints the largest eigenvalue is around 0.7. Such triangles can occur when removing hydrogen angle vibrations with an additional angle constraint in alcohol groups or when constraining water molecules with LINCS, for instance with flexible constraints. The constraints in such triangles converge twice as slow as the other constraints. Therefore, starting with GROMACS 4, additional terms are added to the expansion for such triangles

$$(\mathbf{I} - \mathbf{A}_n)^{-1} \approx \mathbf{I} + \mathbf{A}_n + \dots + \mathbf{A}_n^{N_i} + (\mathbf{A}_n^* + \dots + \mathbf{A}_n^{*N_i}) \mathbf{A}_n^{N_i} \quad (3.113)$$

where N_i is the normal order of the expansion and \mathbf{A}^* only contains the elements of \mathbf{A} that couple constraints within rigid triangles, all other elements are zero. In this manner, the accuracy of angle constraints comes close to that of the other constraints, while the series of matrix vector multiplications required for determining the expansion only needs to be extended for a few constraint couplings. This procedure is described in the P-LINCS paper[47].

The LINCS Parameters

The accuracy of LINCS depends on the number of matrices used in the expansion eqn. 3.112. For MD calculations a fourth order expansion is enough. For Brownian dynamics with large time steps an eighth order expansion may be necessary. The order is a parameter in the `*.mdp` file. The implementation of LINCS is done in such a way that the algorithm will never crash. Even when it is impossible to reset the constraints LINCS will generate a conformation which fulfills the constraints as well as possible. However, LINCS will generate a warning when in one step a bond rotates over more than a predefined angle. This angle is set by the user in the `*.mdp` file.

3.7 Simulated Annealing

The well known simulated annealing (SA) protocol is supported in GROMACS, and you can even couple multiple groups of atoms separately with an arbitrary number of reference temperatures that change during the simulation. The annealing is implemented by simply changing the current reference temperature for each group in the temperature coupling, so the actual relaxation and coupling properties depends on the type of thermostat you use and how hard you are coupling it. Since we are changing the reference temperature it is important to remember that the system will

NOT instantaneously reach this value - you need to allow for the inherent relaxation time in the coupling algorithm too. If you are changing the annealing reference temperature faster than the temperature relaxation you will probably end up with a crash when the difference becomes too large.

The annealing protocol is specified as a series of corresponding times and reference temperatures for each group, and you can also choose whether you only want a single sequence (after which the temperature will be coupled to the last reference value), or if the annealing should be periodic and restart at the first reference point once the sequence is completed. You can mix and match both types of annealing and non-annealed groups in your simulation.

3.8 Stochastic Dynamics

Stochastic or velocity Langevin dynamics adds a friction and a noise term to Newton's equations of motion, as

$$m_i \frac{d^2 \mathbf{r}_i}{dt^2} = -m_i \gamma_i \frac{d\mathbf{r}_i}{dt} + \mathbf{F}_i(\mathbf{r}) + \dot{\mathbf{r}}_i, \quad (3.114)$$

where γ_i is the friction constant [1/ps] and $\dot{\mathbf{r}}_i(t)$ is a noise process with $\langle \dot{\mathbf{r}}_i(t) \dot{\mathbf{r}}_j(t+s) \rangle = 2m_i \gamma_i k_B T \delta(s) \delta_{ij}$. When $1/\gamma_i$ is large compared to the time scales present in the system, one could see stochastic dynamics as molecular dynamics with stochastic temperature-coupling. The advantage compared to MD with Berendsen temperature-coupling is that in case of SD the generated ensemble is known. For simulating a system in vacuum there is the additional advantage that there is no accumulation of errors for the overall translational and rotational degrees of freedom. When $1/\gamma_i$ is small compared to the time scales present in the system, the dynamics will be completely different from MD, but the sampling is still correct.

In GROMACS there are two algorithms to integrate equation (3.114): a simple and efficient one and a more complex leap-frog algorithm [48]. The accuracy of both integrators is equivalent to the normal MD leap-frog and velocity-Verlet integrator, except with constraints where the simple SD integrator is significantly less accurate. There is a proper way of applying constraints with the simple integrator, but that requires a second constraining step [49], which diminishes the gain. The simple integrator is:

$$\mathbf{v}(t + \frac{1}{2}\Delta t) = \alpha \mathbf{v}(t - \frac{1}{2}\Delta t) + \frac{1 - \alpha}{m\gamma} \mathbf{F}(t) + \sqrt{\frac{k_B T}{m}(1 - \alpha^2)} \mathbf{r}_i^G \quad (3.115)$$

$$\mathbf{r}(t + \Delta t) = \mathbf{r}(t) + \Delta t \mathbf{v}(t + \frac{1}{2}\Delta t) \quad (3.116)$$

$$\alpha = \left(1 - \frac{\gamma \Delta t}{m}\right) \quad (3.117)$$

where \mathbf{r}_i^G is Gaussian distributed noise with $\mu = 0$, $\sigma = 1$. With constraints you should only consider using the simple integrator when $\gamma \Delta t / m \ll 0.01$.

In the complex algorithm four Gaussian random numbers are required per integration step per degree of freedom, and with constraints the coordinates need to be constrained twice per integration step. Depending on the computational cost of the force calculation, this can take a significant part of the simulation time. Exact continuation of a stochastic dynamics simulation is not possible,

because the state of the random number generator is not stored. When using SD as a thermostat, an appropriate value for γ is 0.5 ps^{-1} , since this results in a friction that is lower than the internal friction of water, while it is high enough to remove excess heat (unless plain cut-off or reaction-field electrostatics is used). With this value of γ the efficient algorithm will usually be accurate enough.

3.9 Brownian Dynamics

In the limit of high friction, stochastic dynamics reduces to Brownian dynamics, also called position Langevin dynamics. This applies to over-damped systems, *i.e.* systems in which the inertia effects are negligible. The equation is

$$\frac{d\mathbf{r}_i}{dt} = \frac{1}{\gamma_i} \mathbf{F}_i(\mathbf{r}) + \dot{\mathbf{r}}_i \quad (3.118)$$

where γ_i is the friction coefficient [amu/ps] and $\dot{\mathbf{r}}_i(t)$ is a noise process with $\langle \dot{\mathbf{r}}_i(t) \dot{\mathbf{r}}_j(t+s) \rangle = 2\delta(s)\delta_{ij}k_B T/\gamma_i$. In GROMACS the equations are integrated with a simple, explicit scheme

$$\mathbf{r}_i(t + \Delta t) = \mathbf{r}_i(t) + \frac{\Delta t}{\gamma_i} \mathbf{F}_i(\mathbf{r}(t)) + \sqrt{2k_B T \frac{\Delta t}{\gamma_i}} \mathbf{r}_i^G, \quad (3.119)$$

where \mathbf{r}_i^G is Gaussian distributed noise with $\mu = 0$, $\sigma = 1$. The friction coefficients γ_i can be chosen the same for all particles or as $\gamma_i = m_i \gamma$, where the friction constants γ can be different for different groups of atoms. Because the system is assumed to be over-damped, large timesteps can be used. LINCS should be used for the constraints since SHAKE will not converge for large atomic displacements. BD is an option of the `mdrun` program.

3.10 Energy Minimization

Energy minimization in GROMACS can be done using steepest descent, conjugate gradients, or l-bfgs (limited-memory Broyden-Fletcher-Goldfarb-Shanno quasi-Newtonian minimizer...we prefer the abbreviation). EM is just an option of the `mdrun` program.

3.10.1 Steepest Descent

Although steepest descent is certainly not the most efficient algorithm for searching, it is robust and easy to implement.

We define the vector \mathbf{r} as the vector of all $3N$ coordinates. Initially a maximum displacement h_0 (*e.g.* 0.01 nm) must be given.

First the forces \mathbf{F} and potential energy are calculated. New positions are calculated by

$$\mathbf{r}_{n+1} = \mathbf{r}_n + \frac{\mathbf{F}_n}{\max(|\mathbf{F}_n|)} h_n, \quad (3.120)$$

where h_n is the maximum displacement and \mathbf{F}_n is the force, or the negative gradient of the potential V . The notation $\max(|\mathbf{F}_n|)$ means the largest of the absolute values of the force components. The forces and energy are again computed for the new positions

If ($V_{n+1} < V_n$) the new positions are accepted and $h_{n+1} = 1.2h_n$.

If ($V_{n+1} \geq V_n$) the new positions are rejected and $h_n = 0.2h_n$.

The algorithm stops when either a user-specified number of force evaluations has been performed (e.g. 100), or when the maximum of the absolute values of the force (gradient) components is smaller than a specified value ϵ . Since force truncation produces some noise in the energy evaluation, the stopping criterion should not be made too tight to avoid endless iterations. A reasonable value for ϵ can be estimated from the root mean square force f a harmonic oscillator would exhibit at a temperature T . This value is

$$f = 2\pi\nu\sqrt{2mkT}, \quad (3.121)$$

where ν is the oscillator frequency, m the (reduced) mass, and k Boltzmann's constant. For a weak oscillator with a wave number of 100 cm^{-1} and a mass of 10 atomic units, at a temperature of 1 K, $f = 7.7 \text{ kJ mol}^{-1} \text{ nm}^{-1}$. A value for ϵ between 1 and 10 is acceptable.

3.10.2 Conjugate Gradient

Conjugate gradient is slower than steepest descent in the early stages of the minimization, but becomes more efficient closer to the energy minimum. The parameters and stop criterion are the same as for steepest descent. In GROMACS conjugate gradient can not be used with constraints, including the SETTLE algorithm for water [44], as this has not been implemented. If water is present it must be of a flexible model, which can be specified in the `*.mdp` file by `define = -DFLEXIBLE`.

This is not really a restriction, since the accuracy of conjugate gradient is only required for minimization prior to a normal-mode analysis, which cannot be performed with constraints. For most other purposes steepest descent is efficient enough.

3.10.3 L-BFGS

The original BFGS algorithm works by successively creating better approximations of the inverse Hessian matrix, and moving the system to the currently estimated minimum. The memory requirements for this are proportional to the square of the number of particles, so it is not practical for large systems like biomolecules. Instead, we use the L-BFGS algorithm of Nocedal [50, 51], which approximates the inverse Hessian by a fixed number of corrections from previous steps. This sliding-window technique is almost as efficient as the original method, but the memory requirements are much lower - proportional to the number of particles multiplied with the correction steps. In practice we have found it to converge faster than conjugate gradients, but due to the correction steps it is not yet parallelized. It is also noteworthy that switched or shifted interactions usually improve the convergence, since sharp cut-offs mean the potential function at the current coordinates is slightly different from the previous steps used to build the inverse Hessian approximation.

3.11 Normal-Mode Analysis

Normal-mode analysis [52, 53, 54] can be performed using GROMACS, by diagonalization of the mass-weighted Hessian H :

$$R^T M^{-1/2} H M^{-1/2} R = \text{diag}(\lambda_1, \dots, \lambda_{3N}) \quad (3.122)$$

$$\lambda_i = (2\pi\omega_i)^2 \quad (3.123)$$

where M contains the atomic masses, R is a matrix that contains the eigenvectors as columns, λ_i are the eigenvalues and ω_i are the corresponding frequencies.

First the Hessian matrix, which is a $3N \times 3N$ matrix where N is the number of atoms, needs to be calculated:

$$H_{ij} = \frac{\partial^2 V}{\partial x_i \partial x_j} \quad (3.124)$$

where x_i and x_j denote the atomic x, y or z coordinates. In practice, this equation is not used, but the Hessian is calculated numerically from the force as:

$$H_{ij} = -\frac{f_i(\mathbf{x} + h\mathbf{e}_j) - f_i(\mathbf{x} - h\mathbf{e}_j)}{2h} \quad (3.125)$$

$$f_i = -\frac{\partial V}{\partial x_i} \quad (3.126)$$

where \mathbf{e}_j is the unit vector in direction j . It should be noted that for a usual normal-mode calculation, it is necessary to completely minimize the energy prior to computation of the Hessian. The tolerance required depends on the type of system, but a rough indication is $0.001 \text{ kJ mol}^{-1}$. Minimization should be done with conjugate gradients or L-BFGS in double precision.

A number of GROMACS programs are involved in these calculations. First, the energy should be minimized using `mdrun`. Then, `mdrun` computes the Hessian. **Note** that for generating the run input file, one should use the minimized conformation from the full precision trajectory file, as the structure file is not accurate enough. `g_nmeig` does the diagonalization and the sorting of the normal modes according to their frequencies. Both `mdrun` and `g_nmeig` should be run in double precision. The normal modes can be analyzed with the program `g_anaeig`. Ensembles of structures at any temperature and for any subset of normal modes can be generated with `g_nmens`. An overview of normal-mode analysis and the related principal component analysis (see sec. 8.10) can be found in [55].

3.12 Free energy calculations

3.12.1 Slow-growth methods

Free energy calculations can be performed in GROMACS using a number of methods, including “slow-growth.” An example problem might be calculating the difference in free energy of binding of an inhibitor **I** to an enzyme **E** and to a mutated enzyme **E'**. It is not feasible with computer simulations to perform a docking calculation for such a large complex, or even releasing the inhibitor

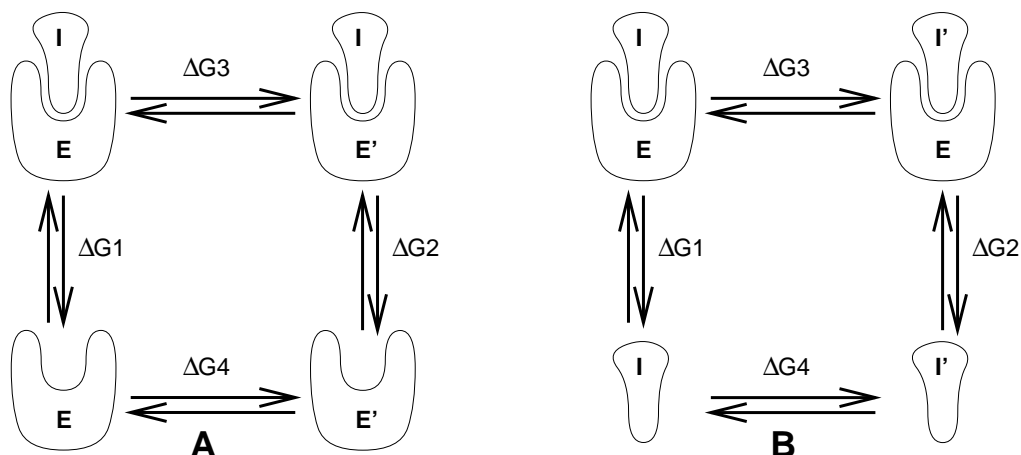

Figure 3.11: Free energy cycles. **A**: to calculate ΔG_{12} , the free energy difference between the binding of inhibitor **I** to enzymes **E** respectively **E'**. **B**: to calculate ΔG_{12} , the free energy difference for binding of inhibitors **I** respectively **I'** to enzyme **E**.

from the enzyme in a reasonable amount of computer time with reasonable accuracy. However, if we consider the free energy cycle in Fig. 3.11A we can write:

$$\Delta G_1 - \Delta G_2 = \Delta G_3 - \Delta G_4 \quad (3.127)$$

If we are interested in the left-hand term we can equally well compute the right-hand term.

If we want to compute the difference in free energy of binding of two inhibitors **I** and **I'** to an enzyme **E** (Fig. 3.11B) we can again use eqn. 3.127 to compute the desired property.

Free energy differences between two molecular species can be calculated in GROMACS using the “slow-growth” method. Such free energy differences between different molecular species are physically meaningless, but they can be used to obtain meaningful quantities employing a thermodynamic cycle. The method requires a simulation during which the Hamiltonian of the system changes slowly from that describing one system (A) to that describing the other system (B). The change must be so slow that the system remains in equilibrium during the process; if that requirement is fulfilled, the change is reversible and a slow-growth simulation from B to A will yield the same results (but with a different sign) as a slow-growth simulation from A to B. This is a useful check, but the user should be aware of the danger that equality of forward and backward growth results does not guarantee correctness of the results.

The required modification of the Hamiltonian H is realized by making H a function of a *coupling parameter* λ : $H = H(p, q; \lambda)$ in such a way that $\lambda = 0$ describes system A and $\lambda = 1$ describes system B:

$$H(p, q; 0) = H^A(p, q); \quad H(p, q; 1) = H^B(p, q). \quad (3.128)$$

In GROMACS, the functional form of the λ -dependence is different for the various force-field contributions and is described in section sec. 4.5.

The Helmholtz free energy A is related to the partition function Q of an N, V, T ensemble, which is assumed to be the equilibrium ensemble generated by a MD simulation at constant volume and temperature. The generally more useful Gibbs free energy G is related to the partition function

Δ of an N, p, T ensemble, which is assumed to be the equilibrium ensemble generated by a MD simulation at constant pressure and temperature:

$$A(\lambda) = -k_B T \ln Q \quad (3.129)$$

$$Q = c \iint \exp[-\beta H(p, q; \lambda)] dp dq \quad (3.130)$$

$$G(\lambda) = -k_B T \ln \Delta \quad (3.131)$$

$$\Delta = c \iiint \exp[-\beta H(p, q; \lambda) - \beta pV] dp dq dV \quad (3.132)$$

$$G = A + pV, \quad (3.133)$$

where $\beta = 1/(k_B T)$ and $c = (N!h^{3N})^{-1}$. These integrals over phase space cannot be evaluated from a simulation, but it is possible to evaluate the derivative with respect to λ as an ensemble average:

$$\frac{dA}{d\lambda} = \frac{\iint (\partial H / \partial \lambda) \exp[-\beta H(p, q; \lambda)] dp dq}{\iint \exp[-\beta H(p, q; \lambda)] dp dq} = \left\langle \frac{\partial H}{\partial \lambda} \right\rangle_{NVT; \lambda}, \quad (3.134)$$

with a similar relation for $dG/d\lambda$ in the N, p, T ensemble. The difference in free energy between A and B can be found by integrating the derivative over λ :

$$A^B(V, T) - A^A(V, T) = \int_0^1 \left\langle \frac{\partial H}{\partial \lambda} \right\rangle_{NVT; \lambda} d\lambda \quad (3.135)$$

$$G^B(p, T) - G^A(p, T) = \int_0^1 \left\langle \frac{\partial H}{\partial \lambda} \right\rangle_{NpT; \lambda} d\lambda. \quad (3.136)$$

If one wishes to evaluate $G^B(p, T) - G^A(p, T)$, the natural choice is a constant-pressure simulation. However, this quantity can also be obtained from a slow-growth simulation at constant volume, starting with system A at pressure p and volume V and ending with system B at pressure p_B , by applying the following small (but, in principle, exact) correction:

$$G^B(p) - G^A(p) = A^B(V) - A^A(V) - \int_p^{p^B} [V^B(p') - V] dp' \quad (3.137)$$

Here we omitted the constant T from the notation. This correction is roughly equal to $-\frac{1}{2}(p^B - p)\Delta V = (\Delta V)^2/(2\kappa V)$, where ΔV is the volume change at p and κ is the isothermal compressibility. This is usually small; for example, the growth of a water molecule from nothing in a bath of 1000 water molecules at constant volume would produce an additional pressure of as much as 22 bar, but a correction to the Helmholtz free energy of just -1 kJ mol^{-1} .

In Cartesian coordinates, the kinetic energy term in the Hamiltonian depends only on the momenta, and can be separately integrated and, in fact, removed from the equations. When masses do not change, there is no contribution from the kinetic energy at all; otherwise the integrated contribution to the free energy is $-\frac{3}{2}k_B T \ln(m^B/m^A)$. **Note** that this is only true in the absence of constraints.

3.12.2 Thermodynamic integration

GROMACS offers the possibility to integrate eq. 3.135 or eq. 3.136 in one simulation over the full range from A to B. However, if the change is large and insufficient sampling can be expected,

the user may prefer to determine the value of $\langle dG/d\lambda \rangle$ accurately at a number of well-chosen intermediate values of λ . This can easily be done by setting the stepsize `delta_lambda` to zero. Each simulation can be equilibrated first, and a proper error estimate can be made for each value of $dG/d\lambda$ from the fluctuation of $\partial H/\partial\lambda$. The total free energy change is then determined afterward by an appropriate numerical integration procedure.

GROMACS now also supports the use of Bennett's Acceptance Ratio [56] for calculating values of ΔG for transformations from state A to state B using the program `g_bar`. The same data can also be used to calculate free energies using MBAR [57], though the analysis currently requires external tools from the external `pymbar` package, at <https://SimTK.org/home/pymbar>.

The λ -dependence for the force-field contributions is described in detail in section sec. 4.5.

3.13 Replica exchange

Replica exchange molecular dynamics (REMD) is a method that can be used to speed up the sampling of any type of simulation, especially if conformations are separated by relatively high energy barriers. It involves simulating multiple replicas of the same system at different temperatures and randomly exchanging the complete state of two replicas at regular intervals with the probability:

$$P(1 \leftrightarrow 2) = \min \left(1, \exp \left[\left(\frac{1}{k_B T_1} - \frac{1}{k_B T_2} \right) (U_1 - U_2) \right] \right) \quad (3.138)$$

where T_1 and T_2 are the reference temperatures and U_1 and U_2 are the instantaneous potential energies of replicas 1 and 2 respectively. After exchange the velocities are scaled by $(T_1/T_2)^{\pm 0.5}$ and a neighbor search is performed the next step. This combines the fast sampling and frequent barrier-crossing of the highest temperature with correct Boltzmann sampling at all the different temperatures [58, 59]. We only attempt exchanges for neighboring temperatures as the probability decreases very rapidly with the temperature difference. One should not attempt exchanges for all possible pairs in one step. If, for instance, replicas 1 and 2 would exchange, the chance of exchange for replicas 2 and 3 not only depends on the energies of replicas 2 and 3, but also on the energy of replica 1. In GROMACS this is solved by attempting exchange for all "odd" pairs on "odd" attempts and for all "even" pairs on "even" attempts. If we have four replicas: 0, 1, 2 and 3, ordered in temperature and we attempt exchange every 1000 steps, pairs 0-1 and 2-3 will be tried at steps 1000, 3000 etc. and pair 1-2 at steps 2000, 4000 etc.

How should one choose the temperatures? The energy difference can be written as:

$$U_1 - U_2 = N_{df} \frac{c}{2} k_B (T_1 - T_2) \quad (3.139)$$

where N_{df} is the total number of degrees of freedom of one replica and c is 1 for harmonic potentials and around 2 for protein/water systems. If $T_2 = (1 + \epsilon)T_1$ the probability becomes:

$$P(1 \leftrightarrow 2) = \exp \left(-\frac{\epsilon^2 c N_{df}}{2(1 + \epsilon)} \right) \approx \exp \left(-\epsilon^2 \frac{c}{2} N_{df} \right) \quad (3.140)$$

Thus for a probability of $e^{-2} \approx 0.135$ one obtains $\epsilon \approx 2/\sqrt{c N_{df}}$. With all bonds constrained one has $N_{df} \approx 2 N_{atoms}$ and thus for $c = 2$ one should choose ϵ as $1/\sqrt{N_{atoms}}$. However there is one

problem when using pressure coupling. The density at higher temperatures will decrease, leading to higher energy [60], which should be taken into account. The GROMACS website features a so-called “REMD calculator,” that lets you type in the temperature range and the number of atoms, and based on that proposes a set of temperatures.

An extension to the REMD for the isobaric-isothermal ensemble was proposed by Okabe *et al.* [61]. In this work the exchange probability is modified to:

$$P(1 \leftrightarrow 2) = \min \left(1, \exp \left[\left(\frac{1}{k_B T_1} - \frac{1}{k_B T_2} \right) (U_1 - U_2) + \left(\frac{P_1}{k_B T_1} - \frac{P_2}{k_B T_2} \right) (V_1 - V_2) \right] \right) \quad (3.141)$$

where P_1 and P_2 are the respective reference pressures and V_1 and V_2 are the respective instantaneous volumes in the simulations. In most cases the differences in volume are so small that the second term is negligible. It only plays a role when the difference between P_1 and P_2 is large or in phase transitions.

Hamiltonian replica exchange is also supported in GROMACS. In Hamiltonian replica exchange, each replica has a different Hamiltonian, defined by the free energy pathway specified for the simulation. The exchange probability to maintain the correct ensemble probabilities is:

$$P(1 \leftrightarrow 2) = \min \left(1, \exp \left[\left(\frac{1}{k_B T} - \frac{1}{k_B T} \right) ((U_1(x_2) - U_1(x_1)) + (U_2(x_1) - U_2(x_2))) \right] \right) \quad (3.142)$$

The separate Hamiltonians are defined by the free energy functionality of GROMACS, with swaps made between the different values of λ defined in the mdp file.

Hamiltonian and temperature replica exchange can also be performed simultaneously, using the acceptance criteria:

$$P(1 \leftrightarrow 2) = \min \left(1, \exp \left[\left(\frac{1}{k_B T} - \frac{1}{k_B T} \right) \left(\frac{U_1(x_2) - U_1(x_1)}{k_B T_1} + \frac{U_2(x_1) - U_2(x_2)}{k_B T_2} \right) \right] \right) \quad (3.143)$$

Gibbs sampling replica exchange has also been implemented in GROMACS [62]. In Gibbs sampling replica exchange, all possible pairs are tested for exchange, allowing swaps between replicas that are not neighbors.

Gibbs sampling replica exchange requires no additional potential energy calculations. However there is an additional communication cost in Gibbs sampling replica exchange, as for some permutations, more than one round of swaps must take place. In some cases, this extra communication cost might affect the efficiency.

All replica exchange variants are options of the `mdrun` program. It will only work when MPI is installed, due to the inherent parallelism in the algorithm. For efficiency each replica can run on a separate node. See the manual page of `mdrun` on how to use these multinode features.

3.14 Essential Dynamics sampling

The results from Essential Dynamics (see sec. 8.10) of a protein can be used to guide MD simulations. The idea is that from an initial MD simulation (or from other sources) a definition of the collective fluctuations with largest amplitude is obtained. The position along one or more of

these collective modes can be constrained in a (second) MD simulation in a number of ways for several purposes. For example, the position along a certain mode may be kept fixed to monitor the average force (free-energy gradient) on that coordinate in that position. Another application is to enhance sampling efficiency with respect to usual MD [63, 64]. In this case, the system is encouraged to sample its available configuration space more systematically than in a diffusion-like path that proteins usually take.

Another possibility to enhance sampling is flooding. Here a flooding potential is added to certain (collective) degrees of freedom to expel the system out of a region of phase space [65].

The procedure for essential dynamics sampling or flooding is as follows. First, the eigenvectors and eigenvalues need to be determined using covariance analysis (`g_covar`) or normal-mode analysis (`g_nmeig`). Then, this information is fed into `make_edi`, which has many options for selecting vectors and setting parameters, see Appendix D for the manual page of `make_edi`. The generated `edi` input file is then passed to `mdrun`.

3.15 Expanded Ensemble

In an expanded ensemble simulation [66], both the coordinates and the thermodynamic ensemble are treated as configuration variables that can be sampled over. The probability of any given state can be written as:

$$P(\vec{x}, k) \propto \exp(-\beta_k U_k + g_k), \quad (3.144)$$

where $\beta_k = \frac{1}{k_B T_k}$ is the β corresponding to the k th thermodynamic state, and g_k is a user-specified weight factor corresponding to the k th state. This space is therefore a *mixed*, *generalized*, or *expanded* ensemble which samples from multiple thermodynamic ensembles simultaneously. g_k is chosen to give a specific weighting of each subensemble in the expanded ensemble, and can either be fixed, or determined by an iterative procedure. The set of g_k is frequently chosen to give each thermodynamic ensemble equal probability, in which case g_k is equal to the free energy in non-dimensional units, but they can be set to arbitrary values as desired. Several different algorithms can be used to equilibrate these weights, described in the `mdp` option listings.

In GROMACS, this space is sampled by alternating sampling in the k and \vec{x} directions. Sampling in the \vec{x} direction is done by standard molecular dynamics sampling; sampling between the different thermodynamics states is done by Monte Carlo, with several different Monte Carlo moves supported. The k states can be defined by different temperatures, or choices of the free energy λ variable, or both. Expanded ensemble simulations thus represent a serialization of the replica exchange formalism, allowing a single simulation to explore many thermodynamic states.

3.16 Parallelization

The CPU time required for a simulation can be reduced by running the simulation in parallel over more than one processor or processor core. Ideally one would want to have linear scaling: running on N processors/cores makes the simulation N times faster. In practice this can only be achieved for a small number of processors. The scaling will depend a lot on the algorithms used. Also, different algorithms can have different restrictions on the interaction ranges between atoms. In

GROMACS we have two types of parallelization: particle decomposition and domain decomposition. Particle decomposition is only useful for a few special cases. Domain decomposition, which is the default algorithm, will always be faster and scale better.

3.17 Particle decomposition

Particle decomposition, also called *particle decomposition*, is the simplest type of decomposition. At the start of the simulation, particles are assigned to processors. Then forces between particles need to be assigned to processors such that the force load is evenly balanced. This decomposition requires that each processor know the coordinates of at least half of the particles in the system. Thus for a high number of processors N , about $N \times N/2$ coordinates need to be communicated. Because of this quadratic relation particle decomposition does not scale well.

Particle decomposition was the only method available before version 4 of GROMACS. Now it is only useful in cases where domain decomposition does not work, such as systems with long-range bonded interactions, especially NMR distance or orientation restraints. With particle decomposition only whole molecules can be assigned to a processor.

3.18 Domain decomposition

Since most interactions in molecular simulations are local, domain decomposition is a natural way to decompose the system. In domain decomposition, a spatial domain is assigned to each processor, which will then integrate the equations of motion for the particles that currently reside in its local domain. With domain decomposition, there are two choices that have to be made: the division of the unit cell into domains and the assignment of the forces to processors. Most molecular simulation packages use the half-shell method for assigning the forces. But there are two methods that always require less communication: the eighth shell [67] and the midpoint [68] method. GROMACS currently uses the eighth shell method, but for certain systems or hardware architectures it might be advantageous to use the midpoint method. Therefore, we might implement the midpoint method in the future. Most of the details of the domain decomposition can be found in the GROMACS 4 paper [5].

3.18.1 Coordinate and force communication

In the most general case of a triclinic unit cell, the space is divided with a 1-, 2-, or 3-D grid in parallelepipeds that we call domain decomposition cells. Each cell is assigned to a processor. The system is partitioned over the processors at the beginning of each MD step in which neighbor searching is performed. Since the neighbor searching is based on charge groups, charge groups are also the units for the domain decomposition. Charge groups are assigned to the cell where their center of geometry resides. Before the forces can be calculated, the coordinates from some neighboring cells need to be communicated, and after the forces are calculated, the forces need to be communicated in the other direction. The communication and force assignment is based on zones that can cover one or multiple cells. An example of a zone setup is shown in Fig. 3.12.

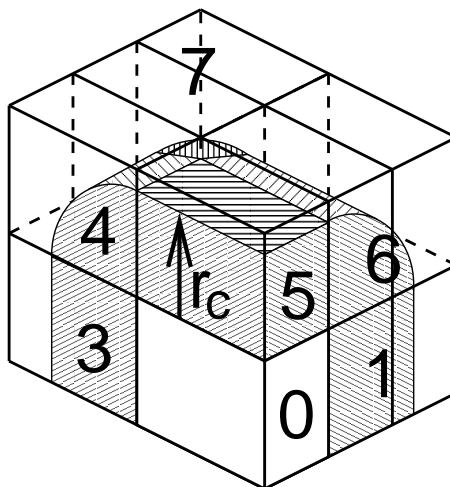

Figure 3.12: A non-staggered domain decomposition grid of $3 \times 2 \times 2$ cells. Coordinates in zones 1 to 7 are communicated to the corner cell that has its home particles in zone 0. r_c is the cut-off radius.

The coordinates are communicated by moving data along the “negative” direction in x , y or z to the next neighbor. This can be done in one or multiple pulses. In Fig. 3.12 two pulses in x are required, then one in y and then one in z . The forces are communicated by reversing this procedure. See the GROMACS 4 paper [5] for details on determining which non-bonded and bonded forces should be calculated on which node.

3.18.2 Dynamic load balancing

When different processors have a different computational load (load imbalance), all processors will have to wait for the one that takes the most time. One would like to avoid such a situation. Load imbalance can occur due to three reasons:

- inhomogeneous particle distribution
- inhomogeneous interaction cost distribution (charged/uncharged, water/non-water due to GROMACS water innerloops)
- statistical fluctuation (only with small particle numbers)

So we need a dynamic load balancing algorithm where the volume of each domain decomposition cell can be adjusted *independently*. To achieve this, the 2- or 3-D domain decomposition grids need to be staggered. Fig. 3.13 shows the most general case in 2-D. Due to the staggering, one might require two distance checks for deciding if a charge group needs to be communicated: a non-bonded distance and a bonded distance check.

By default, `mdrun` automatically turns on the dynamic load balancing during a simulation when the total performance loss due to the force calculation imbalance is 5% or more. **Note** that the reported force load imbalance numbers might be higher, since the force calculation is only part of

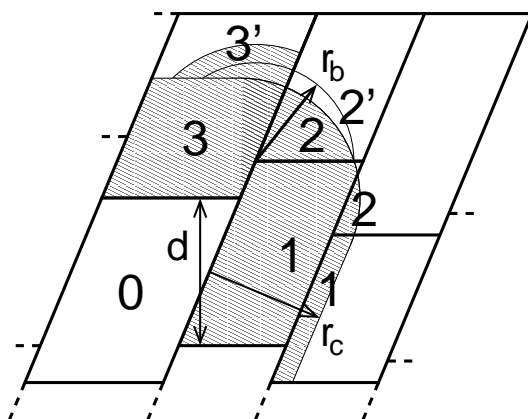

Figure 3.13: The zones to communicate to the processor of zone 0, see the text for details. r_c and r_b are the non-bonded and bonded cut-off radii respectively, d is an example of a distance between following, staggered boundaries of cells.

work that needs to be done during an integration step. The load imbalance is reported in the log file at log output steps and when the `-v` option is used also on screen. The average load imbalance and the total performance loss due to load imbalance are reported at the end of the log file.

There is one important parameter for the dynamic load balancing, which is the minimum allowed scaling. By default, each dimension of the domain decomposition cell can scale down by at least a factor of 0.8. For 3-D domain decomposition this allows cells to change their volume by about a factor of 0.5, which should allow for compensation of a load imbalance of 100%. The required scaling can be changed with the `-dds` option of `mdrun`.

3.18.3 Constraints in parallel

Since with domain decomposition parts of molecules can reside on different processors, bond constraints can cross cell boundaries. Therefore a parallel constraint algorithm is required. GRO-MACS uses the P-LINCS algorithm [47], which is the parallel version of the LINCS algorithm [46] (see 3.6.2). The P-LINCS procedure is illustrated in Fig. 3.14. When molecules cross the cell boundaries, atoms in such molecules up to `(lincs_order + 1)` bonds away are communicated over the cell boundaries. Then, the normal LINCS algorithm can be applied to the local bonds plus the communicated ones. After this procedure, the local bonds are correctly constrained, even though the extra communicated ones are not. One coordinate communication step is required for the initial LINCS step and one for each iteration. Forces do not need to be communicated.

3.18.4 Interaction ranges

Domain decomposition takes advantage of the locality of interactions. This means that there will be limitations on the range of interactions. By default, `mdrun` tries to find the optimal balance between interaction range and efficiency. But it can happen that a simulation stops with an error message about missing interactions, or that a simulation might run slightly faster with shorter interaction ranges. A list of interaction ranges and their default values is given in Table 3.3.

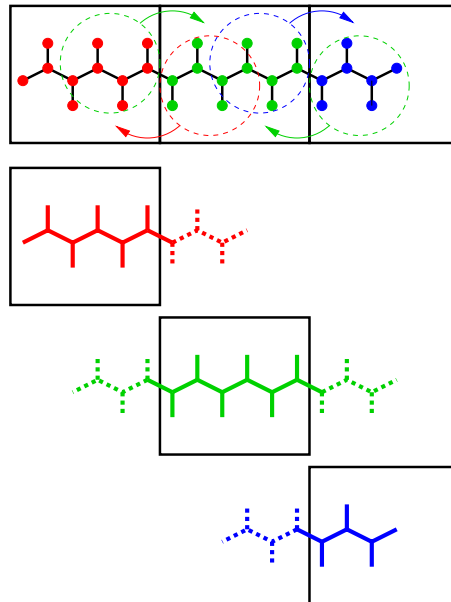

Figure 3.14: Example of the parallel setup of P-LINCS with one molecule split over three domain decomposition cells, using a matrix expansion order of 3. The top part shows which atom coordinates need to be communicated to which cells. The bottom parts show the local constraints (solid) and the non-local constraints (dashed) for each of the three cells.

interaction	range	option	default
non-bonded	$r_c = \max(r_{list}, r_{VdW}, r_{Coul})$	mdp file	
two-body bonded	$\max(r_{mb}, r_c)$	mdrun -rdd	starting conf. + 10%
multi-body bonded	r_{mb}	mdrun -rdd	starting conf. + 10%
constraints	r_{con}	mdrun -rcon	est. from bond lengths
virtual sites	r_{con}	mdrun -rcon	0

Table 3.3: The interaction ranges with domain decomposition.

In most cases the defaults of `mdrun` should not cause the simulation to stop with an error message of missing interactions. The range for the bonded interactions is determined from the distance between bonded charge-groups in the starting configuration, with 10% added for headroom. For the constraints, the value of r_{con} is determined by taking the maximum distance that $(\text{links_order} + 1)$ bonds can cover when they all connect at angles of 120 degrees. The actual constraint communication is not limited by r_{con} , but by the minimum cell size L_C , which has the following lower limit:

$$L_C \geq \max(r_{mb}, r_{con}) \quad (3.145)$$

Without dynamic load balancing the system is actually allowed to scale beyond this limit when pressure scaling is used. **Note** that for triclinic boxes, L_C is not simply the box diagonal component divided by the number of cells in that direction, rather it is the shortest distance between the triclinic cells borders. For rhombic dodecahedra this is a factor of $\sqrt{3/2}$ shorter along x and y .

When $r_{mb} > r_c$, `mdrun` employs a smart algorithm to reduce the communication. Simply communicating all charge groups within r_{mb} would increase the amount of communication enormously. Therefore only charge-groups that are connected by bonded interactions to charge groups which are not locally present are communicated. This leads to little extra communication, but also to a slightly increased cost for the domain decomposition setup. In some cases, *e.g.* coarse-grained simulations with a very short cut-off, one might want to set r_{mb} by hand to reduce this cost.

3.18.5 Multiple-Program, Multiple-Data PME parallelization

Electrostatics interactions are long-range, therefore special algorithms are used to avoid summation over many atom pairs. In GROMACS this is usually .PME (sec. 4.9.2). Since with PME all particles interact with each other, global communication is required. This will usually be the limiting factor for scaling with domain decomposition. To reduce the effect of this problem, we have come up with a Multiple-Program, Multiple-Data approach [5]. Here, some processors are selected to do only the PME mesh calculation, while the other processors, called particle-particle (PP) nodes, do all the rest of the work. For rectangular boxes the optimal PP to PME node ratio is usually 3:1, for rhombic dodecahedra usually 2:1. When the number of PME nodes is reduced by a factor of 4, the number of communication calls is reduced by about a factor of 16. Or put differently, we can now scale to 4 times more nodes. In addition, for modern 4 or 8 core machines in a network, the effective network bandwidth for PME is quadrupled, since only a quarter of the cores will be using the network connection on each machine during the PME calculations.

`mdrun` will by default interleave the PP and PME nodes. If the processors are not number consecutively inside the machines, one might want to use `mdrun -ddorder pp_pme`. For machines with a real 3-D torus and proper communication software that assigns the processors accordingly one should use `mdrun -ddorder cartesian`.

To optimize the performance one should usually set up the cut-offs and the PME grid such that the PME load is 25 to 33% of the total calculation load. `grompp` will print an estimate for this load at the end and also `mdrun` calculates the same estimate to determine the optimal number of PME nodes to use. For high parallelization it might be worthwhile to optimize the PME load with the `mdp` settings and/or the number of PME nodes with the `-npme` option of `mdrun`. For changing the electrostatics settings it is useful to know the accuracy of the electrostatics remains nearly constant when the Coulomb cut-off and the PME grid spacing are scaled by the same factor. **Note**

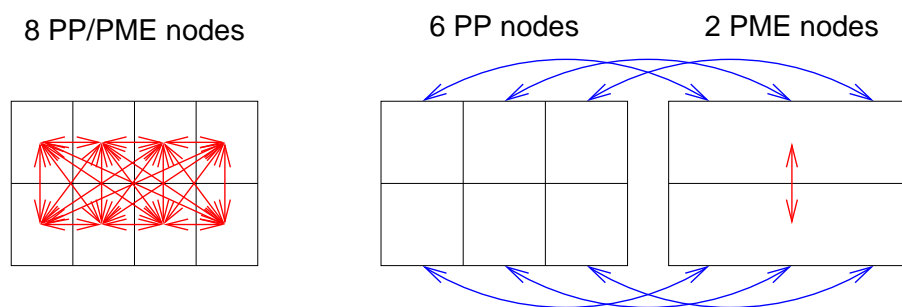

Figure 3.15: Example of 8 nodes without (left) and with (right) MPMD. The PME communication (red arrows) is much higher on the left than on the right. For MPMD additional PP - PME coordinate and force communication (blue arrows) is required, but the total communication complexity is lower.

that it is usually better to overestimate than to underestimate the number of PME nodes, since the number of PME nodes is smaller than the number of PP nodes, which leads to less total waiting time.

The PME domain decomposition can be 1-D or 2-D along the x and/or y axis. 2-D decomposition is also known as pencil decomposition because of the shape of the domains at high parallelization. 1-D decomposition along the y axis can only be used when the PP decomposition has only 1 domain along x . 2-D PME decomposition has to have the number of domains along x equal to the number of the PP decomposition. `mdrun` automatically chooses 1-D or 2-D PME decomposition (when possible with the total given number of nodes), based on the minimum amount of communication for the coordinate redistribution in PME plus the communication for the grid overlap and transposes. To avoid superfluous communication of coordinates and forces between the PP and PME nodes, the number of DD cells in the x direction should ideally be the same or a multiple of the number of PME nodes. By default, `mdrun` takes care of this issue.

3.18.6 Domain decomposition flow chart

In Fig. 3.16 a flow chart is shown for domain decomposition with all possible communication for different algorithms. For simpler simulations, the same flow chart applies, without the algorithms and communication for the algorithms that are not used.

3.19 Implicit solvation

Implicit solvent models provide an efficient way of representing the electrostatic effects of solvent molecules, while saving a large piece of the computations involved in an accurate, aqueous description of the surrounding water in molecular dynamics simulations. Implicit solvation models offer several advantages compared with explicit solvation, including eliminating the need for the equilibration of water around the solute, and the absence of viscosity, which allows the protein to more quickly explore conformational space.

Implicit solvent calculations in GROMACS can be done using the generalized Born-formalism,

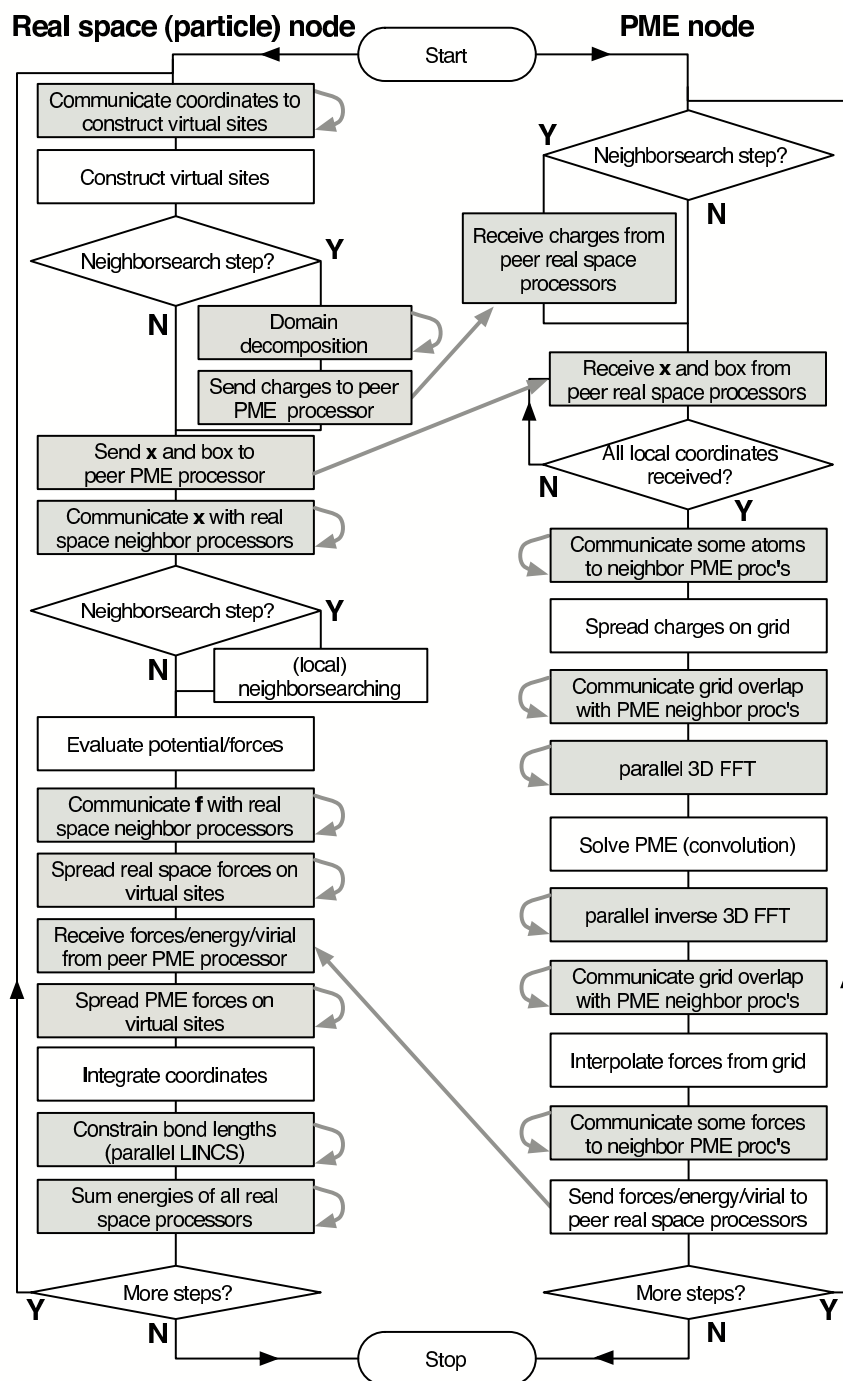

Figure 3.16: Flow chart showing the algorithms and communication (arrows) for a standard MD simulation with virtual sites, constraints and separate PME-mesh nodes.

and the Still [69], HCT [70], and OBC [71] models are available for calculating the Born radii.

Here, the free energy G_{solv} of solvation is the sum of three terms, a solvent-solvent cavity term (G_{cav}), a solute-solvent van der Waals term (G_{vdw}), and finally a solvent-solute electrostatics polarization term (G_{pol}).

The sum of G_{cav} and G_{vdw} corresponds to the (non-polar) free energy of solvation for a molecule from which all charges have been removed, and is commonly called G_{np} , calculated from the total solvent accessible surface area multiplied with a surface tension. The total expression for the solvation free energy then becomes:

$$G_{solv} = G_{np} + G_{pol} \quad (3.146)$$

Under the generalized Born model, G_{pol} is calculated from the generalized Born equation [69]:

$$G_{pol} = \left(1 - \frac{1}{\epsilon}\right) \sum_{i=1}^n \sum_{j>i}^n \frac{q_i q_j}{\sqrt{r_{ij}^2 + b_i b_j} \exp\left(\frac{-r_{ij}^2}{4b_i b_j}\right)} \quad (3.147)$$

In GROMACS, we have introduced the substitution [72]:

$$c_i = \frac{1}{\sqrt{b_i}} \quad (3.148)$$

which makes it possible to introduce a cheap transformation to a new variable x when evaluating each interaction, such that:

$$x = \frac{r_{ij}}{\sqrt{b_i b_j}} = r_{ij} c_i c_j \quad (3.149)$$

In the end, the full re-formulation of 3.147 becomes:

$$G_{pol} = \left(1 - \frac{1}{\epsilon}\right) \sum_{i=1}^n \sum_{j>i}^n \frac{q_i q_j}{\sqrt{b_i b_j}} \xi(x) = \left(1 - \frac{1}{\epsilon}\right) \sum_{i=1}^n q_i c_i \sum_{j>i}^n q_j c_j \xi(x) \quad (3.150)$$

The non-polar part (G_{np}) of Equation 3.146 is calculated directly from the Born radius of each atom using a simple ACE type approximation by Schaefer *et al.* [73], including a simple loop over all atoms. This requires only one extra solvation parameter, independent of atom type, but differing slightly between the three Born radii models.

Chapter 4

Interaction function and force fields

To accommodate the potential functions used in some popular force fields (see 4.10), GROMACS offers a choice of functions, both for non-bonded interaction and for dihedral interactions. They are described in the appropriate subsections.

The potential functions can be subdivided into three parts

1. *Non-bonded*: Lennard-Jones or Buckingham, and Coulomb or modified Coulomb. The non-bonded interactions are computed on the basis of a neighbor list (a list of non-bonded atoms within a certain radius), in which exclusions are already removed.
2. *Bonded*: covalent bond-stretching, angle-bending, improper dihedrals, and proper dihedrals. These are computed on the basis of fixed lists.
3. *Restraints*: position restraints, angle restraints, distance restraints, orientation restraints and dihedral restraints, all based on fixed lists.

4.1 Non-bonded interactions

Non-bonded interactions in GROMACS are pair-additive and centro-symmetric:

$$V(\mathbf{r}_1, \dots, \mathbf{r}_N) = \sum_{i < j} V_{ij}(\mathbf{r}_{ij}); \quad (4.1)$$

$$\mathbf{F}_i = - \sum_j \frac{dV_{ij}(r_{ij})}{dr_{ij}} \frac{\mathbf{r}_{ij}}{r_{ij}} = -\mathbf{F}_j \quad (4.2)$$

The non-bonded interactions contain a repulsion term, a dispersion term, and a Coulomb term. The repulsion and dispersion term are combined in either the Lennard-Jones (or 6-12 interaction), or the Buckingham (or exp-6 potential). In addition, (partially) charged atoms act through the Coulomb term.

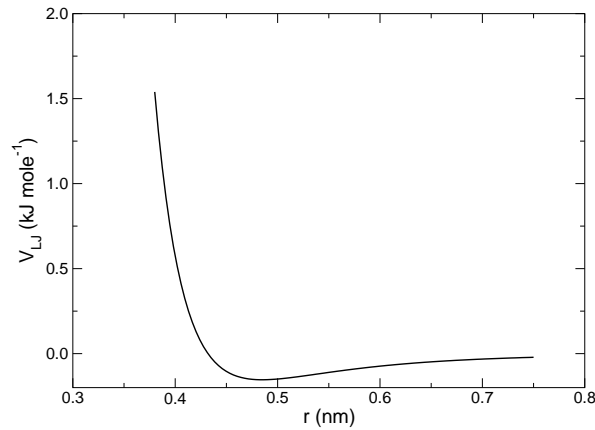

Figure 4.1: The Lennard-Jones interaction.

4.1.1 The Lennard-Jones interaction

The Lennard-Jones potential V_{LJ} between two atoms equals:

$$V_{LJ}(r_{ij}) = \frac{C_{ij}^{(12)}}{r_{ij}^{12}} - \frac{C_{ij}^{(6)}}{r_{ij}^6} \quad (4.3)$$

See also Fig. 4.1 The parameters $C_{ij}^{(12)}$ and $C_{ij}^{(6)}$ depend on pairs of *atom types*; consequently they are taken from a matrix of LJ-parameters. In the Verlet cut-off scheme, the potential is shifted by a constant such that it is zero at the cut-off distance.

The force derived from this potential is:

$$\mathbf{F}_i(\mathbf{r}_{ij}) = \left(12 \frac{C_{ij}^{(12)}}{r_{ij}^{13}} - 6 \frac{C_{ij}^{(6)}}{r_{ij}^7} \right) \frac{\mathbf{r}_{ij}}{r_{ij}} \quad (4.4)$$

The LJ potential may also be written in the following form:

$$V_{LJ}(\mathbf{r}_{ij}) = 4\epsilon_{ij} \left(\left(\frac{\sigma_{ij}}{r_{ij}} \right)^{12} - \left(\frac{\sigma_{ij}}{r_{ij}} \right)^6 \right) \quad (4.5)$$

In constructing the parameter matrix for the non-bonded LJ-parameters, two types of combination rules can be used within GROMACS, only geometric averages (type 1 in the input section of the force field file):

$$\begin{aligned} C_{ij}^{(6)} &= \left(C_{ii}^{(6)} C_{jj}^{(6)} \right)^{1/2} \\ C_{ij}^{(12)} &= \left(C_{ii}^{(12)} C_{jj}^{(12)} \right)^{1/2} \end{aligned} \quad (4.6)$$

or, alternatively the Lorentz-Berthelot rules can be used. An arithmetic average is used to calculate σ_{ij} , while a geometric average is used to calculate ϵ_{ij} (type 2):

$$\begin{aligned} \sigma_{ij} &= \frac{1}{2}(\sigma_{ii} + \sigma_{jj}) \\ \epsilon_{ij} &= (\epsilon_{ii} \epsilon_{jj})^{1/2} \end{aligned} \quad (4.7)$$

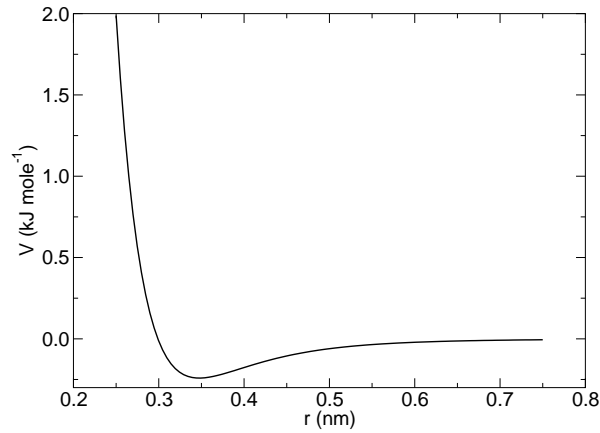

Figure 4.2: The Buckingham interaction.

finally an geometric average for both parameters can be used (type 3):

$$\begin{aligned}\sigma_{ij} &= (\sigma_{ii} \sigma_{jj})^{1/2} \\ \epsilon_{ij} &= (\epsilon_{ii} \epsilon_{jj})^{1/2}\end{aligned}\quad (4.8)$$

This last rule is used by the OPLS force field.

4.1.2 Buckingham potential

The Buckingham potential has a more flexible and realistic repulsion term than the Lennard-Jones interaction, but is also more expensive to compute. The potential form is:

$$V_{bh}(r_{ij}) = A_{ij} \exp(-B_{ij}r_{ij}) - \frac{C_{ij}}{r_{ij}^6} \quad (4.9)$$

See also Fig. 4.2. The force derived from this is:

$$\mathbf{F}_i(r_{ij}) = \left[A_{ij} B_{ij} \exp(-B_{ij}r_{ij}) - 6 \frac{C_{ij}}{r_{ij}^7} \right] \frac{\mathbf{r}_{ij}}{r_{ij}} \quad (4.10)$$

4.1.3 Coulomb interaction

The Coulomb interaction between two charge particles is given by:

$$V_c(r_{ij}) = f \frac{q_i q_j}{\epsilon_r r_{ij}} \quad (4.11)$$

See also Fig. 4.3, where $f = \frac{1}{4\pi\epsilon_0} = 138.935\,485$ (see chapter 2)

The force derived from this potential is:

$$\mathbf{F}_i(r_{ij}) = f \frac{q_i q_j}{\epsilon_r r_{ij}^2} \frac{\mathbf{r}_{ij}}{r_{ij}} \quad (4.12)$$

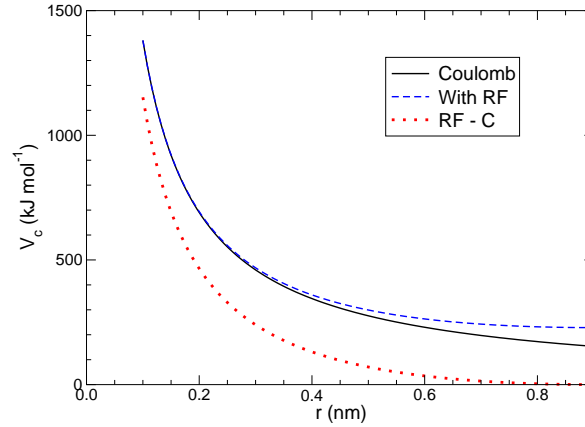

Figure 4.3: The Coulomb interaction (for particles with equal signed charge) with and without reaction field. In the latter case ϵ_r was 1, ϵ_{rf} was 78, and r_c was 0.9 nm. The dot-dashed line is the same as the dashed line, except for a constant.

In GROMACS the relative dielectric constant ϵ_r may be set in the in the input for `grompp`.

4.1.4 Coulomb interaction with reaction field

The Coulomb interaction can be modified for homogeneous systems by assuming a constant dielectric environment beyond the cut-off r_c with a dielectric constant of ϵ_{rf} . The interaction then reads:

$$V_{crf} = f \frac{q_i q_j}{\epsilon_r r_{ij}} \left[1 + \frac{\epsilon_{rf} - \epsilon_r}{2\epsilon_{rf} + \epsilon_r} \frac{r_{ij}^3}{r_c^3} \right] - f \frac{q_i q_j}{\epsilon_r r_c} \frac{3\epsilon_{rf}}{2\epsilon_{rf} + \epsilon_r} \quad (4.13)$$

in which the constant expression on the right makes the potential zero at the cut-off r_c . For charged cut-off spheres this corresponds to neutralization with a homogeneous background charge. We can rewrite eqn. 4.13 for simplicity as

$$V_{crf} = f \frac{q_i q_j}{\epsilon_r} \left[\frac{1}{r_{ij}} + k_{rf} r_{ij}^2 - c_{rf} \right] \quad (4.14)$$

with

$$k_{rf} = \frac{1}{r_c^3} \frac{\epsilon_{rf} - \epsilon_r}{(2\epsilon_{rf} + \epsilon_r)} \quad (4.15)$$

$$c_{rf} = \frac{1}{r_c} + k_{rf} r_c^2 = \frac{1}{r_c} \frac{3\epsilon_{rf}}{(2\epsilon_{rf} + \epsilon_r)} \quad (4.16)$$

For large ϵ_{rf} the k_{rf} goes to $r_c^{-3}/2$, while for $\epsilon_{rf} = \epsilon_r$ the correction vanishes. In Fig. 4.3 the modified interaction is plotted, and it is clear that the derivative with respect to r_{ij} ($=$ -force) goes to zero at the cut-off distance. The force derived from this potential reads:

$$\mathbf{F}_i(\mathbf{r}_{ij}) = f \frac{q_i q_j}{\epsilon_r} \left[\frac{1}{r_{ij}^2} - 2k_{rf} r_{ij} \right] \frac{\mathbf{r}_{ij}}{r_{ij}} \quad (4.17)$$

The reaction-field correction should also be applied to all excluded atoms pairs, including self pairs, in which case the normal Coulomb term in eqns. 4.13 and 4.17 is absent.

Tironi *et al.* have introduced a generalized reaction field in which the dielectric continuum beyond the cut-off r_c also has an ionic strength I [74]. In this case we can rewrite the constants k_{rf} and c_{rf} using the inverse Debye screening length κ :

$$\kappa^2 = \frac{2I F^2}{\varepsilon_0 \varepsilon_{rf} RT} = \frac{F^2}{\varepsilon_0 \varepsilon_{rf} RT} \sum_{i=1}^K c_i z_i^2 \quad (4.18)$$

$$k_{rf} = \frac{1}{r_c^3} \frac{(\varepsilon_{rf} - \varepsilon_r)(1 + \kappa r_c) + \frac{1}{2} \varepsilon_{rf} (\kappa r_c)^2}{(2\varepsilon_{rf} + \varepsilon_r)(1 + \kappa r_c) + \varepsilon_{rf} (\kappa r_c)^2} \quad (4.19)$$

$$c_{rf} = \frac{1}{r_c} \frac{3\varepsilon_{rf}(1 + \kappa r_c + \frac{1}{2}(\kappa r_c)^2)}{(2\varepsilon_{rf} + \varepsilon_r)(1 + \kappa r_c) + \varepsilon_{rf} (\kappa r_c)^2} \quad (4.20)$$

where F is Faraday's constant, R is the ideal gas constant, T the absolute temperature, c_i the molar concentration for species i and z_i the charge number of species i where we have K different species. In the limit of zero ionic strength ($\kappa = 0$) eqns. 4.19 and 4.20 reduce to the simple forms of eqns. 4.15 and 4.16 respectively.

4.1.5 Modified non-bonded interactions

In GROMACS, the non-bonded potentials can be modified by a shift function. The purpose of this is to replace the truncated forces by forces that are continuous and have continuous derivatives at the cut-off radius. With such forces the timestep integration produces much smaller errors and there are no such complications as creating charges from dipoles by the truncation procedure. In fact, by using shifted forces there is no need for charge groups in the construction of neighbor lists. However, the shift function produces a considerable modification of the Coulomb potential. Unless the "missing" long-range potential is properly calculated and added (through the use of PPPM, Ewald, or PME), the effect of such modifications must be carefully evaluated. The modification of the Lennard-Jones dispersion and repulsion is only minor, but it does remove the noise caused by cut-off effects.

There is *no* fundamental difference between a switch function (which multiplies the potential with a function) and a shift function (which adds a function to the force or potential) [75]. The switch function is a special case of the shift function, which we apply to the *force function* $F(r)$, related to the electrostatic or van der Waals force acting on particle i by particle j as:

$$\mathbf{F}_i = cF(r_{ij}) \frac{\mathbf{r}_{ij}}{r_{ij}} \quad (4.21)$$

For pure Coulomb or Lennard-Jones interactions $F(r) = F_\alpha(r) = r^{-(\alpha+1)}$. The shifted force $F_s(r)$ can generally be written as:

$$\begin{aligned} F_s(r) &= F_\alpha(r) & r < r_1 \\ F_s(r) &= F_\alpha(r) + S(r) & r_1 \leq r < r_c \\ F_s(r) &= 0 & r_c \leq r \end{aligned} \quad (4.22)$$

When $r_1 = 0$ this is a traditional shift function, otherwise it acts as a switch function. The corresponding shifted coulomb potential then reads:

$$V_s(r_{ij}) = f\Phi_s(r_{ij})q_iq_j \quad (4.23)$$

where $\Phi(r)$ is the potential function

$$\Phi_s(r) = \int_r^\infty F_s(x) dx \quad (4.24)$$

The GROMACS shift function should be smooth at the boundaries, therefore the following boundary conditions are imposed on the shift function:

$$\begin{aligned} S(r_1) &= 0 \\ S'(r_1) &= 0 \\ S(r_c) &= -F_\alpha(r_c) \\ S'(r_c) &= -F'_\alpha(r_c) \end{aligned} \quad (4.25)$$

A 3^{rd} degree polynomial of the form

$$S(r) = A(r - r_1)^2 + B(r - r_1)^3 \quad (4.26)$$

fulfills these requirements. The constants A and B are given by the boundary condition at r_c :

$$\begin{aligned} A &= -\frac{(\alpha + 4)r_c - (\alpha + 1)r_1}{r_c^{\alpha+2} (r_c - r_1)^2} \\ B &= \frac{(\alpha + 3)r_c - (\alpha + 1)r_1}{r_c^{\alpha+2} (r_c - r_1)^3} \end{aligned} \quad (4.27)$$

Thus the total force function is:

$$F_s(r) = \frac{\alpha}{r^{\alpha+1}} + A(r - r_1)^2 + B(r - r_1)^3 \quad (4.28)$$

and the potential function reads:

$$\Phi(r) = \frac{1}{r^\alpha} - \frac{A}{3}(r - r_1)^3 - \frac{B}{4}(r - r_1)^4 - C \quad (4.29)$$

where

$$C = \frac{1}{r_c^\alpha} - \frac{A}{3}(r_c - r_1)^3 - \frac{B}{4}(r_c - r_1)^4 \quad (4.30)$$

When $r_1 = 0$, the modified Coulomb force function is

$$F_s(r) = \frac{1}{r^2} - \frac{5r^2}{r_c^4} + \frac{4r^3}{r_c^5} \quad (4.31)$$

which is identical to the function recommended to be used as a short-range function in conjunction with a Poisson solver for the long-range part [76]. The modified Coulomb potential function is:

$$\Phi(r) = \frac{1}{r} - \frac{5}{3r_c} + \frac{5r^3}{3r_c^4} - \frac{r^4}{r_c^5} \quad (4.32)$$

See also Fig. 4.4.

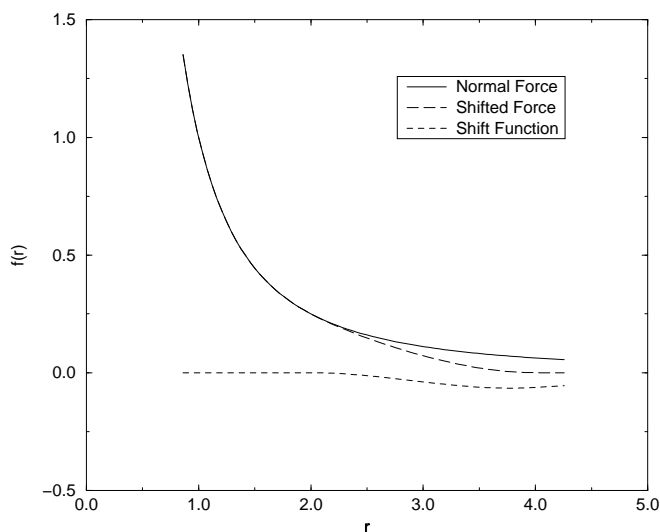

Figure 4.4: The Coulomb Force, Shifted Force and Shift Function $S(r)$, using $r_1 = 2$ and $r_c = 4$.

4.1.6 Modified short-range interactions with Ewald summation

When Ewald summation or particle-mesh Ewald is used to calculate the long-range interactions, the short-range Coulomb potential must also be modified, similar to the switch function above. In this case the short range potential is given by:

$$V(r) = f \frac{\text{erfc}(\beta r_{ij})}{r_{ij}} q_i q_j, \quad (4.33)$$

where β is a parameter that determines the relative weight between the direct space sum and the reciprocal space sum and $\text{erfc}(x)$ is the complementary error function. For further details on long-range electrostatics, see sec. 4.9.

4.2 Bonded interactions

Bonded interactions are based on a fixed list of atoms. They are not exclusively pair interactions, but include 3- and 4-body interactions as well. There are *bond stretching* (2-body), *bond angle* (3-body), and *dihedral angle* (4-body) interactions. A special type of dihedral interaction (called *improper dihedral*) is used to force atoms to remain in a plane or to prevent transition to a configuration of opposite chirality (a mirror image).

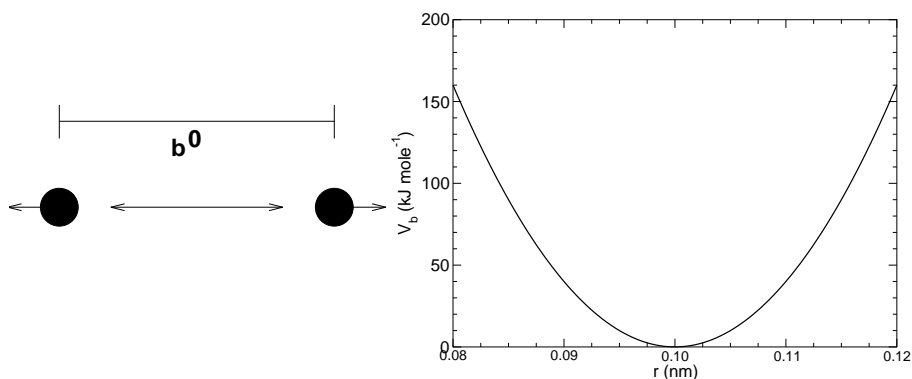

Figure 4.5: Principle of bond stretching (left), and the bond stretching potential (right).

4.2.1 Bond stretching

Harmonic potential

The bond stretching between two covalently bonded atoms i and j is represented by a harmonic potential:

$$V_b(r_{ij}) = \frac{1}{2}k_{ij}^b(r_{ij} - b_{ij})^2 \quad (4.34)$$

See also Fig. 4.5, with the force given by:

$$\mathbf{F}_i(\mathbf{r}_{ij}) = k_{ij}^b(r_{ij} - b_{ij})\frac{\mathbf{r}_{ij}}{r_{ij}} \quad (4.35)$$

Fourth power potential

In the GROMOS-96 force field [77], the covalent bond potential is, for reasons of computational efficiency, written as:

$$V_b(r_{ij}) = \frac{1}{4}k_{ij}^b(r_{ij}^2 - b_{ij}^2)^2 \quad (4.36)$$

The corresponding force is:

$$\mathbf{F}_i(\mathbf{r}_{ij}) = k_{ij}^b(r_{ij}^2 - b_{ij}^2)\mathbf{r}_{ij} \quad (4.37)$$

The force constants for this form of the potential are related to the usual harmonic force constant $k^{b,harm}$ (sec. 4.2.1) as

$$2k^b b_{ij}^2 = k^{b,harm} \quad (4.38)$$

The force constants are mostly derived from the harmonic ones used in GROMOS-87 [78]. Although this form is computationally more efficient (because no square root has to be evaluated), it is conceptually more complex. One particular disadvantage is that since the form is not harmonic, the average energy of a single bond is not equal to $\frac{1}{2}kT$ as it is for the normal harmonic potential.

4.2.2 Morse potential bond stretching

For some systems that require an anharmonic bond stretching potential, the Morse potential [79] between two atoms i and j is available in GROMACS. This potential differs from the harmonic potential in that it has an asymmetric potential well and a zero force at infinite distance. The functional form is:

$$V_{morse}(r_{ij}) = D_{ij}[1 - \exp(-\beta_{ij}(r_{ij} - b_{ij}))]^2, \quad (4.39)$$

See also Fig. 4.6, and the corresponding force is:

$$\mathbf{F}_{morse}(\mathbf{r}_{ij}) = 2D_{ij}\beta_{ij}r_{ij} \exp(-\beta_{ij}(r_{ij} - b_{ij})) * [1 - \exp(-\beta_{ij}(r_{ij} - b_{ij}))] \frac{\mathbf{r}_{ij}}{r_{ij}}, \quad (4.40)$$

where D_{ij} is the depth of the well in kJ/mol, β_{ij} defines the steepness of the well (in nm^{-1}), and b_{ij} is the equilibrium distance in nm. The steepness parameter β_{ij} can be expressed in terms of the reduced mass of the atoms i and j , the fundamental vibration frequency ω_{ij} and the well depth D_{ij} :

$$\beta_{ij} = \omega_{ij} \sqrt{\frac{\mu_{ij}}{2D_{ij}}} \quad (4.41)$$

and because $\omega = \sqrt{k/\mu}$, one can rewrite β_{ij} in terms of the harmonic force constant k_{ij} :

$$\beta_{ij} = \sqrt{\frac{k_{ij}}{2D_{ij}}} \quad (4.42)$$

For small deviations $(r_{ij} - b_{ij})$, one can approximate the exp-term to first-order using a Taylor expansion:

$$\exp(-x) \approx 1 - x \quad (4.43)$$

and substituting eqn. 4.42 and eqn. 4.43 in the functional form:

$$\begin{aligned} V_{morse}(r_{ij}) &= D_{ij}[1 - \exp(-\beta_{ij}(r_{ij} - b_{ij}))]^2 \\ &= D_{ij}[1 - (1 - \sqrt{\frac{k_{ij}}{2D_{ij}}}(r_{ij} - b_{ij}))]^2 \\ &= \frac{1}{2}k_{ij}(r_{ij} - b_{ij})^2 \end{aligned} \quad (4.44)$$

we recover the harmonic bond stretching potential.

4.2.3 Cubic bond stretching potential

Another anharmonic bond stretching potential that is slightly simpler than the Morse potential adds a cubic term in the distance to the simple harmonic form:

$$V_b(r_{ij}) = k_{ij}^b(r_{ij} - b_{ij})^2 + k_{ij}^b k_{ij}^{cub}(r_{ij} - b_{ij})^3 \quad (4.45)$$

A flexible water model (based on the SPC water model [80]) including a cubic bond stretching potential for the O-H bond was developed by Ferguson [81]. This model was found to yield a reasonable infrared spectrum. The Ferguson water model is available in the GROMACS library

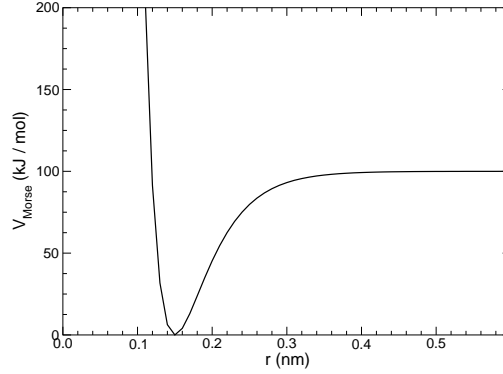

Figure 4.6: The Morse potential well, with bond length 0.15 nm.

(`flexwat-ferguson.itp`). It should be noted that the potential is asymmetric: overstretching leads to infinitely low energies. The integration timestep is therefore limited to 1 fs.

The force corresponding to this potential is:

$$\mathbf{F}_i(\mathbf{r}_{ij}) = 2k_{ij}^b(r_{ij} - b_{ij}) \frac{\mathbf{r}_{ij}}{r_{ij}} + 3k_{ij}^b k_{ij}^{cub} (r_{ij} - b_{ij})^2 \frac{\mathbf{r}_{ij}}{r_{ij}} \quad (4.46)$$

4.2.4 FENE bond stretching potential

In coarse-grained polymer simulations the beads are often connected by a FENE (finitely extensible nonlinear elastic) potential [82]:

$$V_{\text{FENE}}(r_{ij}) = -\frac{1}{2} k_{ij}^b b_{ij}^2 \log \left(1 - \frac{r_{ij}^2}{b_{ij}^2} \right) \quad (4.47)$$

The potential looks complicated, but the expression for the force is simpler:

$$F_{\text{FENE}}(\mathbf{r}_{ij}) = -k_{ij}^b \left(1 - \frac{r_{ij}^2}{b_{ij}^2} \right)^{-1} \mathbf{r}_{ij} \quad (4.48)$$

At short distances the potential asymptotically goes to a harmonic potential with force constant k^b , while it diverges at distance b .

4.2.5 Harmonic angle potential

The bond-angle vibration between a triplet of atoms $i - j - k$ is also represented by a harmonic potential on the angle θ_{ijk}

$$V_a(\theta_{ijk}) = \frac{1}{2} k_{ijk}^\theta (\theta_{ijk} - \theta_{ijk}^0)^2 \quad (4.49)$$

As the bond-angle vibration is represented by a harmonic potential, the form is the same as the bond stretching (Fig. 4.5).

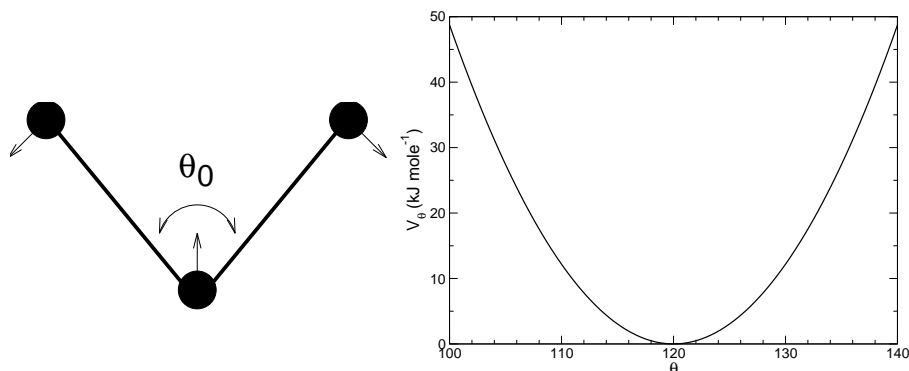

Figure 4.7: Principle of angle vibration (left) and the bond angle potential (right).

The force equations are given by the chain rule:

$$\begin{aligned} \mathbf{F}_i &= -\frac{dV_a(\theta_{ijk})}{dr_i} \\ \mathbf{F}_k &= -\frac{dV_a(\theta_{ijk})}{dr_k} \\ \mathbf{F}_j &= -\mathbf{F}_i - \mathbf{F}_k \end{aligned} \quad \text{where} \quad \theta_{ijk} = \arccos \frac{(\mathbf{r}_{ij} \cdot \mathbf{r}_{kj})}{r_{ij}r_{kj}} \quad (4.50)$$

The numbering i, j, k is in sequence of covalently bonded atoms. Atom j is in the middle; atoms i and k are at the ends (see Fig. 4.7). **Note** that in the input in topology files, angles are given in degrees and force constants in kJ/mol/rad^2 .

4.2.6 Cosine based angle potential

In the GROMOS-96 force field a simplified function is used to represent angle vibrations:

$$V_a(\theta_{ijk}) = \frac{1}{2} k_{ijk}^\theta \left(\cos(\theta_{ijk}) - \cos(\theta_{ijk}^0) \right)^2 \quad (4.51)$$

where

$$\cos(\theta_{ijk}) = \frac{\mathbf{r}_{ij} \cdot \mathbf{r}_{kj}}{r_{ij}r_{kj}} \quad (4.52)$$

The corresponding force can be derived by partial differentiation with respect to the atomic positions. The force constants in this function are related to the force constants in the harmonic form $k^{\theta, harm}$ (4.2.5) by:

$$k^\theta \sin^2(\theta_{ijk}^0) = k^{\theta, harm} \quad (4.53)$$

In the GROMOS-96 manual there is a much more complicated conversion formula which is temperature dependent. The formulas are equivalent at 0 K and the differences at 300 K are on the order of 0.1 to 0.2%. **Note** that in the input in topology files, angles are given in degrees and force constants in kJ/mol .

4.2.7 Urey-Bradley potential

The Urey-Bradley bond-angle vibration between a triplet of atoms $i - j - k$ is represented by a harmonic potential on the angle θ_{ijk} and a harmonic correction term on the distance between the atoms i and k . Although this can be easily written as a simple sum of two terms, it is convenient to have it as a single entry in the topology file and in the output as a separate energy term. It is used mainly in the CHARMM force field [83]. The energy is given by:

$$V_a(\theta_{ijk}) = \frac{1}{2}k_{ijk}^\theta(\theta_{ijk} - \theta_{ijk}^0)^2 + \frac{1}{2}k_{ijk}^{UB}(r_{ik} - r_{ik}^0)^2 \quad (4.54)$$

The force equations can be deduced from sections 4.2.1 and 4.2.5.

4.2.8 Bond-Bond cross term

The bond-bond cross term for three particles i, j, k forming bonds $i - j$ and $k - j$ is given by [84]:

$$V_{rr'} = k_{rr'} (|\mathbf{r}_i - \mathbf{r}_j| - r_{1e}) (|\mathbf{r}_k - \mathbf{r}_j| - r_{2e}) \quad (4.55)$$

where $k_{rr'}$ is the force constant, and r_{1e} and r_{2e} are the equilibrium bond lengths of the $i - j$ and $k - j$ bonds respectively. The force associated with this potential on particle i is:

$$\mathbf{F}_i = -k_{rr'} (|\mathbf{r}_k - \mathbf{r}_j| - r_{2e}) \frac{\mathbf{r}_i - \mathbf{r}_j}{|\mathbf{r}_i - \mathbf{r}_j|} \quad (4.56)$$

The force on atom k can be obtained by swapping i and k in the above equation. Finally, the force on atom j follows from the fact that the sum of internal forces should be zero: $\mathbf{F}_j = -\mathbf{F}_i - \mathbf{F}_k$.

4.2.9 Bond-Angle cross term

The bond-angle cross term for three particles i, j, k forming bonds $i - j$ and $k - j$ is given by [84]:

$$V_{r\theta} = k_{r\theta} (|\mathbf{r}_i - \mathbf{r}_k| - r_{3e}) (|\mathbf{r}_i - \mathbf{r}_j| - r_{1e} + |\mathbf{r}_k - \mathbf{r}_j| - r_{2e}) \quad (4.57)$$

where $k_{r\theta}$ is the force constant, r_{3e} is the $i - k$ distance, and the other constants are the same as in Equation 4.55. The force associated with the potential on atom i is:

$$\mathbf{F}_i = -k_{r\theta} \left[(|\mathbf{r}_i - \mathbf{r}_k| - r_{3e}) \frac{\mathbf{r}_i - \mathbf{r}_j}{|\mathbf{r}_i - \mathbf{r}_j|} + (|\mathbf{r}_i - \mathbf{r}_j| - r_{1e} + |\mathbf{r}_k - \mathbf{r}_j| - r_{2e}) \frac{\mathbf{r}_i - \mathbf{r}_k}{|\mathbf{r}_i - \mathbf{r}_k|} \right] \quad (4.58)$$

4.2.10 Quartic angle potential

For special purposes there is an angle potential that uses a fourth order polynomial:

$$V_q(\theta_{ijk}) = \sum_{n=0}^5 C_n (\theta_{ijk} - \theta_{ijk}^0)^n \quad (4.59)$$

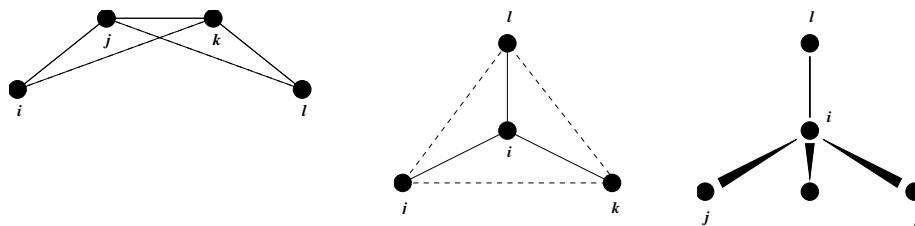

Figure 4.8: Principle of improper dihedral angles. Out of plane bending for rings (left), substituents of rings (middle), out of tetrahedral (right). The improper dihedral angle ξ is defined as the angle between planes (i,j,k) and (j,k,l) in all cases.

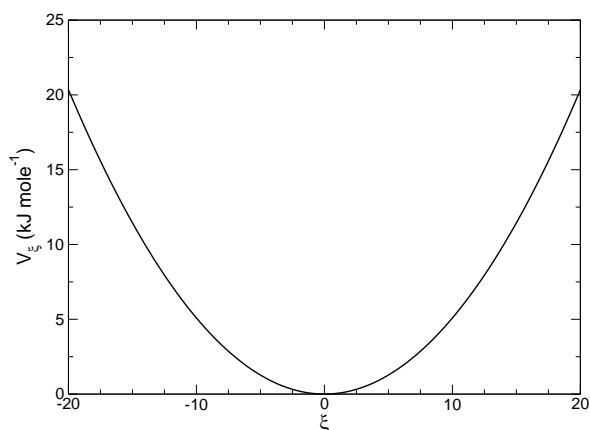

Figure 4.9: Improper dihedral potential.

4.2.11 Improper dihedrals

Improper dihedrals are meant to keep planar groups (*e.g.* aromatic rings) planar, or to prevent molecules from flipping over to their mirror images, see Fig. 4.8.

Improper dihedrals: harmonic type

The simplest improper dihedral potential is a harmonic potential; it is plotted in Fig. 4.9.

$$V_{id}(\xi_{ijkl}) = \frac{1}{2}k_{\xi}(\xi_{ijkl} - \xi_0)^2 \quad (4.60)$$

Since the potential is harmonic it is discontinuous, but since the discontinuity is chosen at 180° distance from ξ_0 this will never cause problems. **Note** that in the input in topology files, angles are given in degrees and force constants in kJ/mol/rad².

Improper dihedrals: periodic type

This potential is identical to the periodic proper dihedral (see below). There is a separate dihedral type for this (type 4) only to be able to distinguish improper from proper dihedrals in the parameter

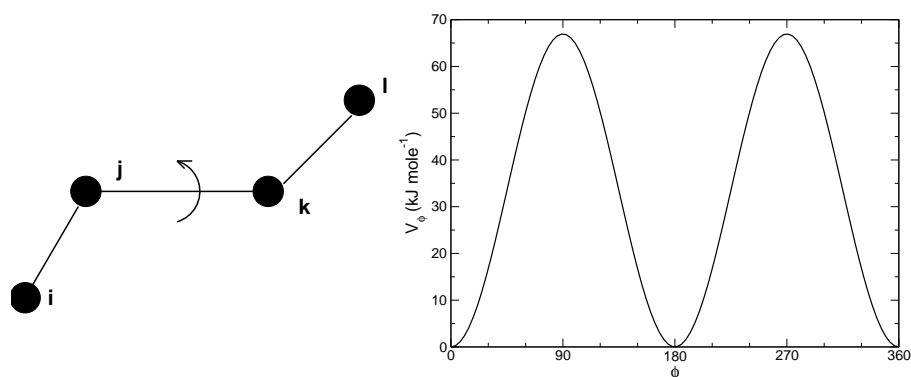

Figure 4.10: Principle of proper dihedral angle (left, in *trans* form) and the dihedral angle potential (right).

section and the output.

4.2.12 Proper dihedrals

For the normal dihedral interaction there is a choice of either the GROMOS periodic function or a function based on expansion in powers of $\cos \phi$ (the so-called Ryckaert-Bellemans potential). This choice has consequences for the inclusion of special interactions between the first and the fourth atom of the dihedral quadruple. With the periodic GROMOS potential a special 1-4 LJ-interaction must be included; with the Ryckaert-Bellemans potential *for alkanes* the 1-4 interactions must be excluded from the non-bonded list. **Note:** Ryckaert-Bellemans potentials are also used in *e.g.* the OPLS force field in combination with 1-4 interactions. You should therefore not modify topologies generated by `pdb2gmx` in this case.

Proper dihedrals: periodic type

Proper dihedral angles are defined according to the IUPAC/IUB convention, where ϕ is the angle between the ijk and the jkl planes, with **zero** corresponding to the *cis* configuration (i and l on the same side). There are two dihedral function types in GROMACS topology files. There is the standard type 1 which behaves like any other bonded interactions. For certain force fields, type 9 is useful. Type 9 allows multiple potential functions to be applied automatically to a single dihedral in the [`dihedral`] section when multiple parameters are defined for the same atomtypes in the [`dihedraltypes`] section.

$$V_d(\phi_{ijkl}) = k_\phi(1 + \cos(n\phi - \phi_s)) \quad (4.61)$$

C_0	9.28	C_2	-13.12	C_4	26.24
C_1	12.16	C_3	-3.06	C_5	-31.5

Table 4.1: Constants for Ryckaert-Bellemans potential (kJ mol^{-1}).

Figure 4.11: Ryckaert-Bellemans dihedral potential.

Proper dihedrals: Ryckaert-Bellemans function

For alkanes, the following proper dihedral potential is often used (see Fig. 4.11):

$$V_{rb}(\phi_{ijkl}) = \sum_{n=0}^5 C_n (\cos(\psi))^n, \quad (4.62)$$

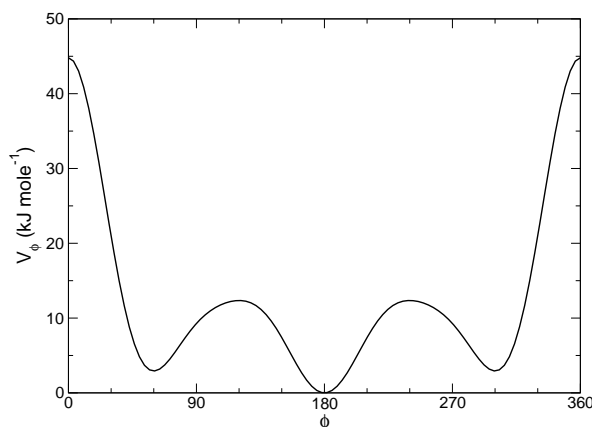
where $\psi = \phi - 180^\circ$.

Note: A conversion from one convention to another can be achieved by multiplying every coefficient C_n by $(-1)^n$.

An example of constants for C is given in Table 4.1.

(Note: The use of this potential implies exclusion of LJ interactions between the first and the last atom of the dihedral, and ψ is defined according to the “polymer convention” ($\psi_{trans} = 0$).)

The RB dihedral function can also be used to include Fourier dihedrals (see below):

$$V_{rb}(\phi_{ijkl}) = \frac{1}{2} [F_1(1 + \cos(\phi)) + F_2(1 - \cos(2\phi)) + F_3(1 + \cos(3\phi)) + F_4(1 - \cos(4\phi))] \quad (4.63)$$

Because of the equalities $\cos(2\phi) = 2\cos^2(\phi) - 1$, $\cos(3\phi) = 4\cos^3(\phi) - 3\cos(\phi)$ and $\cos(4\phi) = 8\cos^4(\phi) - 8\cos^2(\phi) + 1$ one can translate the OPLS parameters to Ryckaert-Bellemans param-

eters as follows:

$$\begin{aligned}
 C_0 &= F_2 + \frac{1}{2}(F_1 + F_3) \\
 C_1 &= \frac{1}{2}(-F_1 + 3F_3) \\
 C_2 &= -F_2 + 4F_4 \\
 C_3 &= -2F_3 \\
 C_4 &= -4F_4 \\
 C_5 &= 0
 \end{aligned}
 \tag{4.64}$$

with OPLS parameters in protein convention and RB parameters in polymer convention (this yields a minus sign for the odd powers of $\cos(\phi)$).

Note: Mind the conversion from kcal mol^{-1} for literature OPLS and RB parameters to kJ mol^{-1} in GROMACS.

Proper dihedrals: Fourier function

The OPLS potential function is given as the first three or four [85] cosine terms of a Fourier series. In GROMACS the four term function is implemented:

$$V_F(\phi_{ijkl}) = \frac{1}{2} [C_1(1 + \cos(\phi)) + C_2(1 - \cos(2\phi)) + C_3(1 + \cos(3\phi)) + C_4(1 + \cos(4\phi))],
 \tag{4.65}$$

Internally, GROMACS uses the Ryckaert-Bellemans code to compute Fourier dihedrals (see above), because this is more efficient.

Note: Mind the conversion from kcal mol^{-1} for literature OPLS parameters to kJ mol^{-1} in GROMACS.

4.2.13 Tabulated bonded interaction functions

For full flexibility, any functional shape can be used for bonds, angles and dihedrals through user-supplied tabulated functions. The functional shapes are:

$$V_b(r_{ij}) = k f_n^b(r_{ij})
 \tag{4.66}$$

$$V_a(\theta_{ijk}) = k f_n^a(\theta_{ijk})
 \tag{4.67}$$

$$V_d(\phi_{ijkl}) = k f_n^d(\phi_{ijkl})
 \tag{4.68}$$

where k is a force constant in units of energy and f is a cubic spline function; for details see 6.9.1. For each interaction, the force constant k and the table number n are specified in the topology. There are two different types of bonds, one that generates exclusions (type 8) and one that does not (type 9). For details see Table 5.5. The table files are supplied to the `mdrun` program. After the table file name an underscore, the letter “b” for bonds, “a” for angles or “d” for dihedrals and the table number are appended. For example, for a bond with $n = 0$ (and using the default table file name) the table is read from the file `table_b0.xvg`. Multiple tables can be supplied simply by using different values of n , and are applied to the appropriate bonds, as specified in the topology (Table 5.5). The format for the table files is three columns with x , $f(x)$, $-f'(x)$, where x should be uniformly-spaced. Requirements for entries in the topology are given in Table 5.5.

The setup of the tables is as follows:

bonds: x is the distance in nm. For distances beyond the table length, mdrun will quit with an error message.

angles: x is the angle in degrees. The table should go from 0 up to and including 180 degrees; the derivative is taken in degrees.

dihedrals: x is the dihedral angle in degrees. The table should go from -180 up to and including 180 degrees; the IUPAC/IUB convention is used, *i.e.* zero is cis, the derivative is taken in degrees.

4.3 Restraints

Special potentials are used for imposing restraints on the motion of the system, either to avoid disastrous deviations, or to include knowledge from experimental data. In either case they are not really part of the force field and the reliability of the parameters is not important. The potential forms, as implemented in GROMACS, are mentioned just for the sake of completeness. Restraints and constraints refer to quite different algorithms in GROMACS.

4.3.1 Position restraints

These are used to restrain particles to fixed reference positions \mathbf{R}_i . They can be used during equilibration in order to avoid drastic rearrangements of critical parts (*e.g.* to restrain motion in a protein that is subjected to large solvent forces when the solvent is not yet equilibrated). Another application is the restraining of particles in a shell around a region that is simulated in detail, while the shell is only approximated because it lacks proper interaction from missing particles outside the shell. Restraining will then maintain the integrity of the inner part. For spherical shells, it is a wise procedure to make the force constant depend on the radius, increasing from zero at the inner boundary to a large value at the outer boundary. This feature has not, however, been implemented in GROMACS.

The following form is used:

$$V_{pr}(\mathbf{r}_i) = \frac{1}{2} k_{pr} |\mathbf{r}_i - \mathbf{R}_i|^2 \quad (4.69)$$

The potential is plotted in Fig. 4.12.

The potential form can be rewritten without loss of generality as:

$$V_{pr}(\mathbf{r}_i) = \frac{1}{2} \left[k_{pr}^x (x_i - X_i)^2 \hat{\mathbf{x}} + k_{pr}^y (y_i - Y_i)^2 \hat{\mathbf{y}} + k_{pr}^z (z_i - Z_i)^2 \hat{\mathbf{z}} \right] \quad (4.70)$$

Now the forces are:

$$\begin{aligned} F_i^x &= -k_{pr}^x (x_i - X_i) \\ F_i^y &= -k_{pr}^y (y_i - Y_i) \\ F_i^z &= -k_{pr}^z (z_i - Z_i) \end{aligned} \quad (4.71)$$

Using three different force constants the position restraints can be turned on or off in each spatial dimension; this means that atoms can be harmonically restrained to a plane or a line. Position restraints are applied to a special fixed list of atoms. Such a list is usually generated by the `pdb2gmx` program.

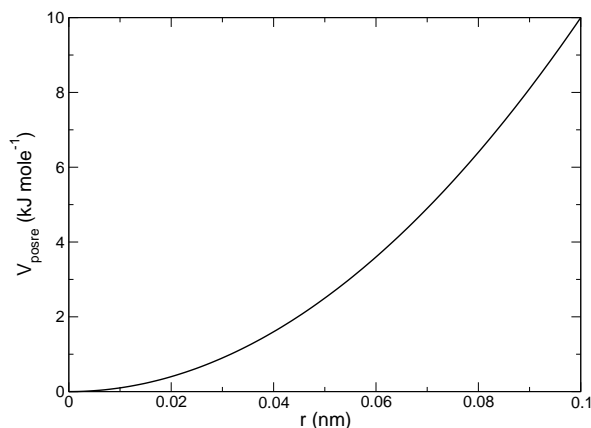

Figure 4.12: Position restraint potential.

4.3.2 Angle restraints

These are used to restrain the angle between two pairs of particles or between one pair of particles and the z -axis. The functional form is similar to that of a proper dihedral. For two pairs of atoms:

$$V_{ar}(\mathbf{r}_i, \mathbf{r}_j, \mathbf{r}_k, \mathbf{r}_l) = k_{ar}(1 - \cos(n(\theta - \theta_0))), \quad \text{where } \theta = \arccos\left(\frac{\mathbf{r}_j - \mathbf{r}_i}{\|\mathbf{r}_j - \mathbf{r}_i\|} \cdot \frac{\mathbf{r}_l - \mathbf{r}_k}{\|\mathbf{r}_l - \mathbf{r}_k\|}\right) \quad (4.72)$$

For one pair of atoms and the z -axis:

$$V_{ar}(\mathbf{r}_i, \mathbf{r}_j) = k_{ar}(1 - \cos(n(\theta - \theta_0))), \quad \text{where } \theta = \arccos\left(\frac{\mathbf{r}_j - \mathbf{r}_i}{\|\mathbf{r}_j - \mathbf{r}_i\|} \cdot \begin{pmatrix} 0 \\ 0 \\ 1 \end{pmatrix}\right) \quad (4.73)$$

A multiplicity (n) of 2 is useful when you do not want to distinguish between parallel and anti-parallel vectors. The equilibrium angle θ should be between 0 and 180 degrees for multiplicity 1 and between 0 and 90 degrees for multiplicity 2.

4.3.3 Dihedral restraints

These are used to restrain the dihedral angle ϕ defined by four particles as in an improper dihedral (sec. 4.2.11) but with a slightly modified potential. Using:

$$\phi' = (\phi - \phi_0) \text{ MOD } 2\pi \quad (4.74)$$

where ϕ_0 is the reference angle, the potential is defined as:

$$V_{dihr}(\phi') = \begin{cases} \frac{1}{2}k_{dihr}(\phi' - \phi_0 - \Delta\phi)^2 & \text{for } \phi' > \Delta\phi \\ 0 & \text{for } \phi' \leq \Delta\phi \end{cases} \quad (4.75)$$

where $\Delta\phi$ is a user defined angle and k_{dihr} is the force constant. **Note** that in the input in topology files, angles are given in degrees and force constants in kJ/mol/rad².

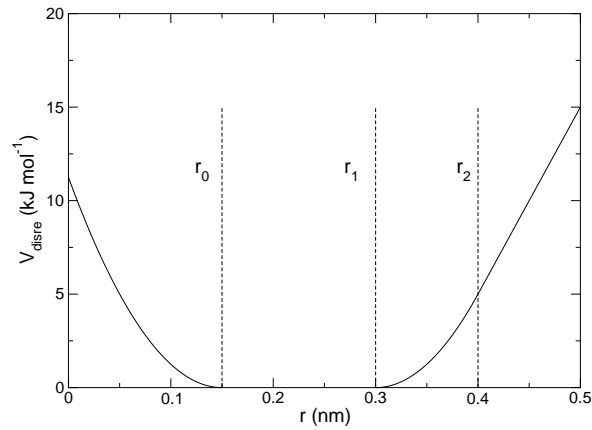

Figure 4.13: Distance Restraint potential.

4.3.4 Distance restraints

Distance restraints add a penalty to the potential when the distance between specified pairs of atoms exceeds a threshold value. They are normally used to impose experimental restraints from, for instance, experiments in nuclear magnetic resonance (NMR), on the motion of the system. Thus, MD can be used for structure refinement using NMR data. In GROMACS there are three ways to impose restraints on pairs of atoms:

- Simple harmonic restraints: use [bonds] type 6 . (see sec. 5.4).
- Piecewise linear/harmonic restraints: [bonds] type 10.
- Complex NMR distance restraints, optionally with pair, time and/or ensemble averaging.

The last two options will be detailed now.

The potential form for distance restraints is quadratic below a specified lower bound and between two specified upper bounds, and linear beyond the largest bound (see Fig. 4.13).

$$V_{dr}(r_{ij}) = \begin{cases} \frac{1}{2}k_{dr}(r_{ij} - r_0)^2 & \text{for } r_{ij} < r_0 \\ 0 & \text{for } r_0 \leq r_{ij} < r_1 \\ \frac{1}{2}k_{dr}(r_{ij} - r_1)^2 & \text{for } r_1 \leq r_{ij} < r_2 \\ \frac{1}{2}k_{dr}(r_2 - r_1)(2r_{ij} - r_2 - r_1) & \text{for } r_2 \leq r_{ij} \end{cases} \quad (4.76)$$

The forces are

$$\mathbf{F}_i = \begin{cases} -k_{dr}(r_{ij} - r_0)\frac{\mathbf{r}_{ij}}{r_{ij}} & \text{for } r_{ij} < r_0 \\ 0 & \text{for } r_0 \leq r_{ij} < r_1 \\ -k_{dr}(r_{ij} - r_1)\frac{\mathbf{r}_{ij}}{r_{ij}} & \text{for } r_1 \leq r_{ij} < r_2 \\ -k_{dr}(r_2 - r_1)\frac{\mathbf{r}_{ij}}{r_{ij}} & \text{for } r_2 \leq r_{ij} \end{cases} \quad (4.77)$$

For restraints not derived from NMR data, this functionality will usually suffice and a section of [`bonds`] type 10 can be used to apply individual restraints between pairs of atoms, see 5.7.1. For applying restraints derived from NMR measurements, more complex functionality might be required, which is provided through the [`distance_restraints`] section and is described below.

Time averaging

Distance restraints based on instantaneous distances can potentially reduce the fluctuations in a molecule significantly. This problem can be overcome by restraining to a *time averaged* distance [86]. The forces with time averaging are:

$$\mathbf{F}_i = \begin{cases} -k_{dr}^a (\bar{r}_{ij} - r_0) \frac{\mathbf{r}_{ij}}{r_{ij}} & \text{for } \bar{r}_{ij} < r_0 \\ 0 & \text{for } r_0 \leq \bar{r}_{ij} < r_1 \\ -k_{dr}^a (\bar{r}_{ij} - r_1) \frac{\mathbf{r}_{ij}}{r_{ij}} & \text{for } r_1 \leq \bar{r}_{ij} < r_2 \\ -k_{dr}^a (r_2 - r_1) \frac{\mathbf{r}_{ij}}{r_{ij}} & \text{for } r_2 \leq \bar{r}_{ij} \end{cases} \quad (4.78)$$

where \bar{r}_{ij} is given by an exponential running average with decay time τ :

$$\bar{r}_{ij} = \langle r_{ij}^{-3} \rangle^{-1/3} \quad (4.79)$$

The force constant k_{dr}^a is switched on slowly to compensate for the lack of history at the beginning of the simulation:

$$k_{dr}^a = k_{dr} \left(1 - \exp\left(-\frac{t}{\tau}\right) \right) \quad (4.80)$$

Because of the time averaging, we can no longer speak of a distance restraint potential.

This way an atom can satisfy two incompatible distance restraints *on average* by moving between two positions. An example would be an amino acid side-chain that is rotating around its χ dihedral angle, thereby coming close to various other groups. Such a mobile side chain can give rise to multiple NOEs that can not be fulfilled by a single structure.

The computation of the time averaged distance in the `mdrun` program is done in the following fashion:

$$\begin{aligned} \bar{r}_{ij}^{-3}(0) &= r_{ij}(0)^{-3} \\ \bar{r}_{ij}^{-3}(t) &= \bar{r}_{ij}^{-3}(t - \Delta t) \exp\left(-\frac{\Delta t}{\tau}\right) + r_{ij}(t)^{-3} \left[1 - \exp\left(-\frac{\Delta t}{\tau}\right) \right] \end{aligned} \quad (4.81)$$

When a pair is within the bounds, it can still feel a force because the time averaged distance can still be beyond a bound. To prevent the protons from being pulled too close together, a mixed approach can be used. In this approach, the penalty is zero when the instantaneous distance is within the bounds, otherwise the violation is the square root of the product of the instantaneous violation and the time averaged violation:

$$\mathbf{F}_i = \begin{cases} k_{dr}^a \sqrt{(r_{ij} - r_0)(\bar{r}_{ij} - r_0)} \frac{\mathbf{r}_{ij}}{r_{ij}} & \text{for } r_{ij} < r_0 \text{ and } \bar{r}_{ij} < r_0 \\ -k_{dr}^a \min\left(\sqrt{(r_{ij} - r_1)(\bar{r}_{ij} - r_1)}, r_2 - r_1\right) \frac{\mathbf{r}_{ij}}{r_{ij}} & \text{for } r_{ij} > r_1 \text{ and } \bar{r}_{ij} > r_1 \\ 0 & \text{otherwise} \end{cases} \quad (4.82)$$

Averaging over multiple pairs

Sometimes it is unclear from experimental data which atom pair gives rise to a single NOE, in other occasions it can be obvious that more than one pair contributes due to the symmetry of the system, *e.g.* a methyl group with three protons. For such a group, it is not possible to distinguish between the protons, therefore they should all be taken into account when calculating the distance between this methyl group and another proton (or group of protons). Due to the physical nature of magnetic resonance, the intensity of the NOE signal is inversely proportional to the sixth power of the inter-atomic distance. Thus, when combining atom pairs, a fixed list of N restraints may be taken together, where the apparent “distance” is given by:

$$r_N(t) = \left[\sum_{n=1}^N \bar{r}_n(t)^{-6} \right]^{-1/6} \quad (4.83)$$

where we use r_{ij} or eqn. 4.79 for the \bar{r}_n . The r_N of the instantaneous and time-averaged distances can be combined to do a mixed restraining, as indicated above. As more pairs of protons contribute to the same NOE signal, the intensity will increase, and the summed “distance” will be shorter than any of its components due to the reciprocal summation.

There are two options for distributing the forces over the atom pairs. In the conservative option, the force is defined as the derivative of the restraint potential with respect to the coordinates. This results in a conservative potential when time averaging is not used. The force distribution over the pairs is proportional to r^{-6} . This means that a close pair feels a much larger force than a distant pair, which might lead to a molecule that is “too rigid.” The other option is an equal force distribution. In this case each pair feels $1/N$ of the derivative of the restraint potential with respect to r_N . The advantage of this method is that more conformations might be sampled, but the non-conservative nature of the forces can lead to local heating of the protons.

It is also possible to use *ensemble averaging* using multiple (protein) molecules. In this case the bounds should be lowered as in:

$$\begin{aligned} r_1 &= r_1 * M^{-1/6} \\ r_2 &= r_2 * M^{-1/6} \end{aligned} \quad (4.84)$$

where M is the number of molecules. The GROMACS preprocessor `grompp` can do this automatically when the appropriate option is given. The resulting “distance” is then used to calculate the scalar force according to:

$$\mathbf{F}_i = \begin{cases} 0 & r_N < r_1 \\ k_{dr}(r_N - r_1) \frac{\mathbf{r}_{ij}}{r_{ij}} & r_1 \leq r_N < r_2 \\ k_{dr}(r_2 - r_1) \frac{\mathbf{r}_{ij}}{r_{ij}} & r_N \geq r_2 \end{cases} \quad (4.85)$$

where i and j denote the atoms of all the pairs that contribute to the NOE signal.

Using distance restraints

A list of distance restraints based on NOE data can be added to a molecule definition in your topology file, like in the following example:

```
[ distance_restraints ]
; ai  aj    type  index  type'  low   up1   up2   fac
10   16     1     0     1      1    0.0   0.3   0.4   1.0
10   28     1     1     1      1    0.0   0.3   0.4   1.0
10   46     1     1     1      1    0.0   0.3   0.4   1.0
16   22     1     2     1      1    0.0   0.3   0.4   2.5
16   34     1     3     1      1    0.0   0.5   0.6   1.0
```

In this example a number of features can be found. In columns `ai` and `aj` you find the atom numbers of the particles to be restrained. The `type` column should always be 1. As explained in 4.3.4, multiple distances can contribute to a single NOE signal. In the topology this can be set using the `index` column. In our example, the restraints 10-28 and 10-46 both have index 1, therefore they are treated simultaneously. An extra requirement for treating restraints together is that the restraints must be on successive lines, without any other intervening restraint. The `type'` column will usually be 1, but can be set to 2 to obtain a distance restraint that will never be time- and ensemble-averaged; this can be useful for restraining hydrogen bonds. The columns `low`, `up1`, and `up2` hold the values of r_0 , r_1 , and r_2 from eqn. 4.76. In some cases it can be useful to have different force constants for some restraints; this is controlled by the column `fac`. The force constant in the parameter file is multiplied by the value in the column `fac` for each restraint.

4.3.5 Orientation restraints

This section describes how orientations between vectors, as measured in certain NMR experiments, can be calculated and restrained in MD simulations. The presented refinement methodology and a comparison of results with and without time and ensemble averaging have been published [87].

Theory

In an NMR experiment, orientations of vectors can be measured when a molecule does not tumble completely isotropically in the solvent. Two examples of such orientation measurements are residual dipolar couplings (between two nuclei) or chemical shift anisotropies. An observable for a vector \mathbf{r}_i can be written as follows:

$$\delta_i = \frac{2}{3} \text{tr}(\mathbf{S}\mathbf{D}_i) \quad (4.86)$$

where \mathbf{S} is the dimensionless order tensor of the molecule. The tensor \mathbf{D}_i is given by:

$$\mathbf{D}_i = \frac{c_i}{\|\mathbf{r}_i\|^\alpha} \begin{pmatrix} 3xx - 1 & 3xy & 3xz \\ 3xy & 3yy - 1 & 3yz \\ 3xz & 3yz & 3zz - 1 \end{pmatrix} \quad (4.87)$$

$$\text{with: } x = \frac{r_{i,x}}{\|\mathbf{r}_i\|}, \quad y = \frac{r_{i,y}}{\|\mathbf{r}_i\|}, \quad z = \frac{r_{i,z}}{\|\mathbf{r}_i\|} \quad (4.88)$$

For a dipolar coupling r_i is the vector connecting the two nuclei, $\alpha = 3$ and the constant c_i is given by:

$$c_i = \frac{\mu_0}{4\pi} \gamma_1^i \gamma_2^i \frac{\hbar}{4\pi} \quad (4.89)$$

where γ_1^i and γ_2^i are the gyromagnetic ratios of the two nuclei.

The order tensor is symmetric and has trace zero. Using a rotation matrix \mathbf{T} it can be transformed into the following form:

$$\mathbf{T}^T \mathbf{S} \mathbf{T} = s \begin{pmatrix} -\frac{1}{2}(1-\eta) & 0 & 0 \\ 0 & -\frac{1}{2}(1+\eta) & 0 \\ 0 & 0 & 1 \end{pmatrix} \quad (4.90)$$

where $-1 \leq s \leq 1$ and $0 \leq \eta \leq 1$. s is called the order parameter and η the asymmetry of the order tensor \mathbf{S} . When the molecule tumbles isotropically in the solvent, s is zero, and no orientational effects can be observed because all δ_i are zero.

Calculating orientations in a simulation

For reasons which are explained below, the \mathbf{D} matrices are calculated which respect to a reference orientation of the molecule. The orientation is defined by a rotation matrix \mathbf{R} , which is needed to least-squares fit the current coordinates of a selected set of atoms onto a reference conformation. The reference conformation is the starting conformation of the simulation. In case of ensemble averaging, which will be treated later, the structure is taken from the first subsystem. The calculated \mathbf{D}_i^c matrix is given by:

$$\mathbf{D}_i^c(t) = \mathbf{R}(t) \mathbf{D}_i(t) \mathbf{R}^T(t) \quad (4.91)$$

The calculated orientation for vector i is given by:

$$\delta_i^c(t) = \frac{2}{3} \text{tr}(\mathbf{S}(t) \mathbf{D}_i^c(t)) \quad (4.92)$$

The order tensor $\mathbf{S}(t)$ is usually unknown. A reasonable choice for the order tensor is the tensor which minimizes the (weighted) mean square difference between the calculated and the observed orientations:

$$MSD(t) = \left(\sum_{i=1}^N w_i \right)^{-1} \sum_{i=1}^N w_i (\delta_i^c(t) - \delta_i^{exp})^2 \quad (4.93)$$

To properly combine different types of measurements, the unit of w_i should be such that all terms are dimensionless. This means the unit of w_i is the unit of δ_i to the power -2 . **Note** that scaling all w_i with a constant factor does not influence the order tensor.

Time averaging

Since the tensors \mathbf{D}_i fluctuate rapidly in time, much faster than can be observed in an experiment, they should be averaged over time in the simulation. However, in a simulation the time and the number of copies of a molecule are limited. Usually one can not obtain a converged average of the \mathbf{D}_i tensors over all orientations of the molecule. If one assumes that the average orientations of

the \mathbf{r}_i vectors within the molecule converge much faster than the tumbling time of the molecule, the tensor can be averaged in an axis system that rotates with the molecule, as expressed by equation (4.91). The time-averaged tensors are calculated using an exponentially decaying memory function:

$$\mathbf{D}_i^a(t) = \frac{\int_{u=t_0}^t \mathbf{D}_i^c(u) \exp\left(-\frac{t-u}{\tau}\right) du}{\int_{u=t_0}^t \exp\left(-\frac{t-u}{\tau}\right) du} \quad (4.94)$$

Assuming that the order tensor \mathbf{S} fluctuates slower than the \mathbf{D}_i , the time-averaged orientation can be calculated as:

$$\delta_i^a(t) = \frac{2}{3} \text{tr}(\mathbf{S}(t) \mathbf{D}_i^a(t)) \quad (4.95)$$

where the order tensor $\mathbf{S}(t)$ is calculated using expression (4.93) with $\delta_i^c(t)$ replaced by $\delta_i^a(t)$.

Restraining

The simulated structure can be restrained by applying a force proportional to the difference between the calculated and the experimental orientations. When no time averaging is applied, a proper potential can be defined as:

$$V = \frac{1}{2} k \sum_{i=1}^N w_i (\delta_i^c(t) - \delta_i^{exp})^2 \quad (4.96)$$

where the unit of k is the unit of energy. Thus the effective force constant for restraint i is kw_i . The forces are given by minus the gradient of V . The force \mathbf{F}_i working on vector \mathbf{r}_i is:

$$\begin{aligned} \mathbf{F}_i(t) &= -\frac{dV}{d\mathbf{r}_i} \\ &= -kw_i (\delta_i^c(t) - \delta_i^{exp}) \frac{d\delta_i^c(t)}{d\mathbf{r}_i} \\ &= -kw_i (\delta_i^c(t) - \delta_i^{exp}) \frac{2c_i}{\|\mathbf{r}\|^{2+\alpha}} \left(2\mathbf{R}^T \mathbf{S} \mathbf{R} \mathbf{r}_i - \frac{2+\alpha}{\|\mathbf{r}\|^2} \text{tr}(\mathbf{R}^T \mathbf{S} \mathbf{R} \mathbf{r}_i \mathbf{r}_i^T) \mathbf{r}_i \right) \end{aligned}$$

Ensemble averaging

Ensemble averaging can be applied by simulating a system of M subsystems that each contain an identical set of orientation restraints. The systems only interact via the orientation restraint potential which is defined as:

$$V = M \frac{1}{2} k \sum_{i=1}^N w_i \langle \delta_i^c(t) - \delta_i^{exp} \rangle^2 \quad (4.97)$$

The force on vector $\mathbf{r}_{i,m}$ in subsystem m is given by:

$$\mathbf{F}_{i,m}(t) = -\frac{dV}{d\mathbf{r}_{i,m}} = -kw_i \langle \delta_i^c(t) - \delta_i^{exp} \rangle \frac{d\delta_{i,m}^c(t)}{d\mathbf{r}_{i,m}} \quad (4.98)$$

Time averaging

When using time averaging it is not possible to define a potential. We can still define a quantity that gives a rough idea of the energy stored in the restraints:

$$V = M \frac{1}{2} k^a \sum_{i=1}^N w_i \langle \delta_i^a(t) - \delta_i^{exp} \rangle^2 \quad (4.99)$$

The force constant k_a is switched on slowly to compensate for the lack of history at times close to t_0 . It is exactly proportional to the amount of average that has been accumulated:

$$k^a = k \frac{1}{\tau} \int_{u=t_0}^t \exp\left(-\frac{t-u}{\tau}\right) du \quad (4.100)$$

What really matters is the definition of the force. It is chosen to be proportional to the square root of the product of the time-averaged and the instantaneous deviation. Using only the time-averaged deviation induces large oscillations. The force is given by:

$$\mathbf{F}_{i,m}(t) = \begin{cases} 0 & \text{for } a b \leq 0 \\ k^a w_i \frac{a}{|a|} \sqrt{a b} \frac{d\delta_{i,m}^c(t)}{d\mathbf{r}_{i,m}} & \text{for } a b > 0 \end{cases} \quad (4.101)$$

$$a = \langle \delta_i^a(t) - \delta_i^{exp} \rangle$$

$$b = \langle \delta_i^c(t) - \delta_i^{exp} \rangle$$

Using orientation restraints

Orientation restraints can be added to a molecule definition in the topology file in the section [orientation_restraints]. Here we give an example section containing five N-H residual dipolar coupling restraints:

```
[ orientation_restraints ]
; ai   aj   type  exp.  label  alpha  const.  obs.  weight
;      aj   type  exp.  label  Hz      nm^3    Hz    Hz^-2
  31   32     1     1     3       3     6.083  -6.73  1.0
  43   44     1     1     4       3     6.083  -7.87  1.0
  55   56     1     1     5       3     6.083  -7.13  1.0
  65   66     1     1     6       3     6.083  -2.57  1.0
  73   74     1     1     7       3     6.083  -2.10  1.0
```

The unit of the observable is Hz, but one can choose any other unit. In columns `ai` and `aj` you find the atom numbers of the particles to be restrained. The `type` column should always be 1. The `exp.` column denotes the experiment number, starting at 1. For each experiment a separate order tensor \mathbf{S} is optimized. The label should be a unique number larger than zero for each restraint. The `alpha` column contains the power α that is used in equation (4.87) to calculate the orientation. The `const.` column contains the constant c_i used in the same equation. The constant should

have the unit of the observable times nm^α . The column `obs.` contains the observable, in any unit you like. The last column contains the weights w_i ; the unit should be the inverse of the square of the unit of the observable.

Some parameters for orientation restraints can be specified in the `grompp.mdp` file, for a study of the effect of different force constants and averaging times and ensemble averaging see [87].

4.4 Polarization

Polarization can be treated by GROMACS by attaching shell (Drude) particles to atoms and/or virtual sites. The energy of the shell particle is then minimized at each time step in order to remain on the Born-Oppenheimer surface.

4.4.1 Simple polarization

This is merely a harmonic potential with equilibrium distance 0.

4.4.2 Water polarization

A special potential for water that allows anisotropic polarization of a single shell particle [42].

4.4.3 Thole polarization

Based on early work by Thole [88], Roux and coworkers have implemented potentials for molecules like ethanol [89, 90, 91]. Within such molecules, there are intra-molecular interactions between shell particles, however these must be screened because full Coulomb would be too strong. The potential between two shell particles i and j is:

$$V_{thole} = \frac{q_i q_j}{r_{ij}} \left[1 - \left(1 + \frac{\bar{r}_{ij}}{2} \right) \exp^{-\bar{r}_{ij}} \right] \quad (4.102)$$

Note that there is a sign error in Equation 1 of Noskov *et al.* [91]:

$$\bar{r}_{ij} = a \frac{r_{ij}}{(\alpha_i \alpha_j)^{1/6}} \quad (4.103)$$

where a is a magic (dimensionless) constant, usually chosen to be 2.6 [91]; α_i and α_j are the polarizabilities of the respective shell particles.

4.5 Free energy interactions

This section describes the λ -dependence of the potentials used for free energy calculations (see sec. 3.12). All common types of potentials and constraints can be interpolated smoothly from state A ($\lambda = 0$) to state B ($\lambda = 1$) and vice versa. All bonded interactions are interpolated by linear

interpolation of the interaction parameters. Non-bonded interactions can be interpolated linearly or via soft-core interactions.

Starting in GROMACS 4.6, λ is a vector, allowing different components of the free energy transformation to be carried out at different rates. Coulomb, Lennard-Jones, bonded, and restraint terms can all be controlled independently, as described in the `.mdp` options.

Harmonic potentials

The example given here is for the bond potential, which is harmonic in GROMACS. However, these equations apply to the angle potential and the improper dihedral potential as well.

$$V_b = \frac{1}{2} [(1 - \lambda)k_b^A + \lambda k_b^B] [b - (1 - \lambda)b_0^A - \lambda b_0^B]^2 \quad (4.104)$$

$$\begin{aligned} \frac{\partial V_b}{\partial \lambda} &= \frac{1}{2} (k_b^B - k_b^A) [b - (1 - \lambda)b_0^A + \lambda b_0^B]^2 + \\ &\quad (b_0^A - b_0^B) [b - (1 - \lambda)b_0^A - \lambda b_0^B] [(1 - \lambda)k_b^A + \lambda k_b^B] \end{aligned} \quad (4.105)$$

GROMOS-96 bonds and angles

Fourth-power bond stretching and cosine-based angle potentials are interpolated by linear interpolation of the force constant and the equilibrium position. Formulas are not given here.

Proper dihedrals

For the proper dihedrals, the equations are somewhat more complicated:

$$V_d = [(1 - \lambda)k_d^A + \lambda k_d^B] \left(1 + \cos [n_\phi \phi - (1 - \lambda)\phi_s^A - \lambda \phi_s^B] \right) \quad (4.106)$$

$$\begin{aligned} \frac{\partial V_d}{\partial \lambda} &= (k_d^B - k_d^A) \left(1 + \cos [n_\phi \phi - (1 - \lambda)\phi_s^A - \lambda \phi_s^B] \right) + \\ &\quad (\phi_s^B - \phi_s^A) [(1 - \lambda)k_d^A - \lambda k_d^B] \sin [n_\phi \phi - (1 - \lambda)\phi_s^A - \lambda \phi_s^B] \end{aligned} \quad (4.107)$$

Note: that the multiplicity n_ϕ can not be parameterized because the function should remain periodic on the interval $[0, 2\pi]$.

Tabulated bonded interactions

For tabulated bonded interactions only the force constant can be interpolated:

$$V = ((1 - \lambda)k^A + \lambda k^B) f \quad (4.108)$$

$$\frac{\partial V}{\partial \lambda} = (k^B - k^A) f \quad (4.109)$$

Coulomb interaction

The Coulomb interaction between two particles of which the charge varies with λ is:

$$V_c = \frac{f}{\varepsilon_{rf} r_{ij}} \left[(1 - \lambda) q_i^A q_j^A + \lambda q_i^B q_j^B \right] \quad (4.110)$$

$$\frac{\partial V_c}{\partial \lambda} = \frac{f}{\varepsilon_{rf} r_{ij}} \left[-q_i^A q_j^A + q_i^B q_j^B \right] \quad (4.111)$$

where $f = \frac{1}{4\pi\varepsilon_0} = 138.935\,485$ (see chapter 2).

Coulomb interaction with reaction field

The Coulomb interaction including a reaction field, between two particles of which the charge varies with λ is:

$$V_c = f \left[\frac{1}{r_{ij}} + k_{rf} r_{ij}^2 - c_{rf} \right] \left[(1 - \lambda) q_i^A q_j^A + \lambda q_i^B q_j^B \right] \quad (4.112)$$

$$\frac{\partial V_c}{\partial \lambda} = f \left[\frac{1}{r_{ij}} + k_{rf} r_{ij}^2 - c_{rf} \right] \left[-q_i^A q_j^A + q_i^B q_j^B \right] \quad (4.113)$$

Note that the constants k_{rf} and c_{rf} are defined using the dielectric constant ε_{rf} of the medium (see sec. 4.1.4).

Lennard-Jones interaction

For the Lennard-Jones interaction between two particles of which the *atom type* varies with λ we can write:

$$V_{LJ} = \frac{(1 - \lambda) C_{12}^A + \lambda C_{12}^B}{r_{ij}^{12}} - \frac{(1 - \lambda) C_6^A + \lambda C_6^B}{r_{ij}^6} \quad (4.114)$$

$$\frac{\partial V_{LJ}}{\partial \lambda} = \frac{C_{12}^B - C_{12}^A}{r_{ij}^{12}} - \frac{C_6^B - C_6^A}{r_{ij}^6} \quad (4.115)$$

It should be noted that it is also possible to express a pathway from state A to state B using σ and ϵ (see eqn. 4.5). It may seem to make sense physically to vary the force field parameters σ and ϵ rather than the derived parameters C_{12} and C_6 . However, the difference between the pathways in parameter space is not large, and the free energy itself does not depend on the pathway, so we use the simple formulation presented above.

Kinetic Energy

When the mass of a particle changes, there is also a contribution of the kinetic energy to the free energy (note that we can not write the momentum \mathbf{p} as $m\mathbf{v}$, since that would result in the sign of $\frac{\partial E_k}{\partial \lambda}$ being incorrect [92]):

$$E_k = \frac{1}{2} \frac{\mathbf{p}^2}{(1-\lambda)m^A + \lambda m^B} \quad (4.116)$$

$$\frac{\partial E_k}{\partial \lambda} = -\frac{1}{2} \frac{\mathbf{p}^2 (m^B - m^A)}{((1-\lambda)m^A + \lambda m^B)^2} \quad (4.117)$$

after taking the derivative, we *can* insert $\mathbf{p} = m\mathbf{v}$, such that:

$$\frac{\partial E_k}{\partial \lambda} = -\frac{1}{2} \mathbf{v}^2 (m^B - m^A) \quad (4.118)$$

Constraints

The constraints are formally part of the Hamiltonian, and therefore they give a contribution to the free energy. In GROMACS this can be calculated using the LINCS or the SHAKE algorithm. If we have a number of constraint equations g_k :

$$g_k = \mathbf{r}_k - d_k \quad (4.119)$$

where \mathbf{r}_k is the distance vector between two particles and d_k is the constraint distance between the two particles, we can write this using a λ -dependent distance as

$$g_k = \mathbf{r}_k - \left((1-\lambda)d_k^A + \lambda d_k^B \right) \quad (4.120)$$

the contribution C_λ to the Hamiltonian using Lagrange multipliers λ :

$$C_\lambda = \sum_k \lambda_k g_k \quad (4.121)$$

$$\frac{\partial C_\lambda}{\partial \lambda} = \sum_k \lambda_k \left(d_k^B - d_k^A \right) \quad (4.122)$$

4.5.1 Soft-core interactions

In a free-energy calculation where particles grow out of nothing, or particles disappear, using the the simple linear interpolation of the Lennard-Jones and Coulomb potentials as described in Equations 4.115 and 4.113 may lead to poor convergence. When the particles have nearly disappeared, or are close to appearing (at λ close to 0 or 1), the interaction energy will be weak enough for particles to get very close to each other, leading to large fluctuations in the measured values of $\partial V/\partial \lambda$ (which, because of the simple linear interpolation, depends on the potentials at both the endpoints of λ).

To circumvent these problems, the singularities in the potentials need to be removed. This can be done by modifying the regular Lennard-Jones and Coulomb potentials with “soft-core” potentials that limit the energies and forces involved at λ values between 0 and 1, but not at $\lambda = 0$ or 1.

In GROMACS the soft-core potentials V_{sc} are shifted versions of the regular potentials, so that the singularity in the potential and its derivatives at $r = 0$ is never reached:

$$V_{sc}(r) = (1-\lambda)V^A(r_A) + \lambda V^B(r_B) \quad (4.123)$$

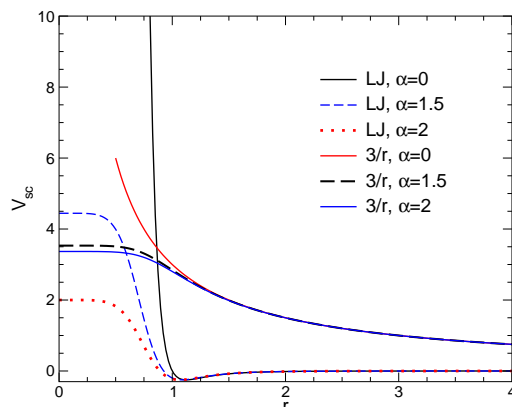

Figure 4.14: Soft-core interactions at $\lambda = 0.5$, with $p = 2$ and $C_6^A = C_{12}^A = C_6^B = C_{12}^B = 1$.

$$r_A = \left(\alpha \sigma_A^6 \lambda^p + r^6 \right)^{\frac{1}{6}} \quad (4.124)$$

$$r_B = \left(\alpha \sigma_B^6 (1 - \lambda)^p + r^6 \right)^{\frac{1}{6}} \quad (4.125)$$

where V^A and V^B are the normal “hard core” Van der Waals or electrostatic potentials in state A ($\lambda = 0$) and state B ($\lambda = 1$) respectively, α is the soft-core parameter (set with `sc_alpha` in the `.mdp` file), p is the soft-core λ power (set with `sc_power`), σ is the radius of the interaction, which is $(C_{12}/C_6)^{1/6}$ or an input parameter (`sc_sigma`) when C_6 or C_{12} is zero.

For intermediate λ , r_A and r_B alter the interactions very little for $r > \alpha^{1/6}\sigma$ and quickly switch the soft-core interaction to an almost constant value for smaller r (Fig. 4.14). The force is:

$$F_{sc}(r) = -\frac{\partial V_{sc}(r)}{\partial r} = (1 - \lambda)F^A(r_A) \left(\frac{r}{r_A} \right)^5 + \lambda F^B(r_B) \left(\frac{r}{r_B} \right)^5 \quad (4.126)$$

where F^A and F^B are the “hard core” forces. The contribution to the derivative of the free energy is:

$$\begin{aligned} \frac{\partial V_{sc}(r)}{\partial \lambda} &= V^B(r_B) - V^A(r_A) + (1 - \lambda) \frac{\partial V^A(r_A)}{\partial r_A} \frac{\partial r_A}{\partial \lambda} + \lambda \frac{\partial V^B(r_B)}{\partial r_B} \frac{\partial r_B}{\partial \lambda} \\ &= V^B(r_B) - V^A(r_A) + \\ &\quad \frac{p\alpha}{6} \left[\lambda F^B(r_B) r_B^{-5} \sigma_B^6 (1 - \lambda)^{p-1} - (1 - \lambda) F^A(r_A) r_A^{-5} \sigma_A^6 \lambda^{p-1} \right] \end{aligned} \quad (4.127)$$

The original GROMOS Lennard-Jones soft-core function [93] uses $p = 2$, but $p = 1$ gives a smoother $\partial H/\partial \lambda$ curve.

Another issue that should be considered is the soft-core effect of hydrogens without Lennard-Jones interaction. Their soft-core σ is set with `sc-sigma` in the `.mdp` file. These hydrogens produce peaks in $\partial H/\partial \lambda$ at λ is 0 and/or 1 for $p = 1$ and close to 0 and/or 1 with $p = 2$. Lowering `sc-sigma` will decrease this effect, but it will also increase the interactions with hydrogens relative to the other interactions in the soft-core state.

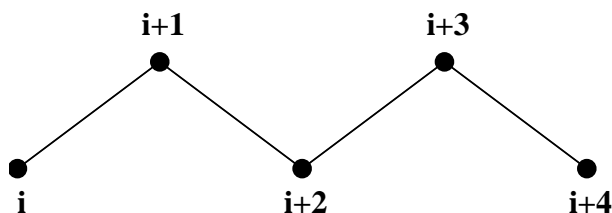

Figure 4.15: Atoms along an alkane chain.

When soft core potentials are selected (by setting `sc-alpha` $\neq 0$), and the Coulomb and Lennard-Jones potentials are turned on or off sequentially, then the Coulombic interaction is turned off linearly, rather than using soft core interactions, which should be less statistically noisy in most cases. This behavior can be overwritten by using the `mdp` option `sc-coul` to 'yes'. Additionally, the soft-core interaction potential is only applied when either the A or B state has zero interaction potential. If both A and B states have nonzero interaction potential, default linear scaling described above is used. When both Coulombic and Lennard-Jones interactions are turned off simultaneously, a soft-core potential is used, and a hydrogen is being introduced or deleted, the `sigma` is set to `sc-sigma-min`, which itself defaults to `sc-sigma-default`.

Recently, a new formulation of the soft-core approach has been derived that in most cases gives lower and more even statistical variance than the standard soft-core path described above. [94, 95] Specifically, we have:

$$V_{sc}(r) = (1 - \lambda)V^A(r_A) + \lambda V^B(r_B) \quad (4.128)$$

$$r_A = \left(\alpha \sigma_A^{48} \lambda^p + r^{48} \right)^{\frac{1}{48}} \quad (4.129)$$

$$r_B = \left(\alpha \sigma_B^{48} (1 - \lambda)^p + r^{48} \right)^{\frac{1}{48}} \quad (4.130)$$

This “1-1-48” path is also implemented in GROMACS. Note that for this path the soft core α should satisfy $0.001 < \alpha < 0.003$, rather than $\alpha \approx 0.5$.

4.6 Methods

4.6.1 Exclusions and 1-4 Interactions.

Atoms within a molecule that are close by in the chain, *i.e.* atoms that are covalently bonded, or linked by one or two atoms are called *first neighbors*, *second neighbors* and *third neighbors*, respectively (see Fig. 4.15). Since the interactions of atom **i** with atoms **i+1** and **i+2** are mainly quantum mechanical, they can not be modeled by a Lennard-Jones potential. Instead it is assumed that these interactions are adequately modeled by a harmonic bond term or constraint (**i**, **i+1**) and a harmonic angle term (**i**, **i+2**). The first and second neighbors (atoms **i+1** and **i+2**) are therefore *excluded* from the Lennard-Jones interaction list of atom **i**; atoms **i+1** and **i+2** are called *exclusions* of atom **i**.

For third neighbors, the normal Lennard-Jones repulsion is sometimes still too strong, which means that when applied to a molecule, the molecule would deform or break due to the internal strain. This is especially the case for carbon-carbon interactions in a *cis*-conformation (*e.g.*

cis-butane). Therefore, for some of these interactions, the Lennard-Jones repulsion has been reduced in the GROMOS force field, which is implemented by keeping a separate list of 1-4 and normal Lennard-Jones parameters. In other force fields, such as OPLS [96], the standard Lennard-Jones parameters are reduced by a factor of two, but in that case also the dispersion (r^{-6}) and the Coulomb interaction are scaled. GROMACS can use either of these methods.

4.6.2 Charge Groups

In principle, the force calculation in MD is an $O(N^2)$ problem. Therefore, we apply a cut-off for non-bonded force (NBF) calculations; only the particles within a certain distance of each other are interacting. This reduces the cost to $O(N)$ (typically $100N$ to $200N$) of the NBF. It also introduces an error, which is, in most cases, acceptable, except when applying the cut-off implies the creation of charges, in which case you should consider using the lattice sum methods provided by GROMACS.

Consider a water molecule interacting with another atom. When we would apply the cut-off on an atom-atom basis we might include the atom-oxygen interaction (with a charge of -0.82) without the compensating charge of the protons, and as a result, induce a large dipole moment over the system. Therefore, we have to keep groups of atoms with total charge 0 together. These groups are called *charge groups*.

4.6.3 Treatment of Cut-offs

GROMACS is quite flexible in treating cut-offs, which implies there can be quite a number of parameters to set. These parameters are set in the input file for `grompp`. There are two sort of parameters that affect the cut-off interactions; you can select which type of interaction to use in each case, and which cut-offs should be used in the neighbor searching.

For both Coulomb and van der Waals interactions there are interaction type selectors (termed `vdwtype` and `coulombtype`) and two parameters, for a total of six non-bonded interaction parameters. See sec. 7.3 for a complete description of these parameters.

The neighbor searching (NS) can be performed using a single-range, or a twin-range approach. Since the former is merely a special case of the latter, we will discuss the more general twin-range. In this case, NS is described by two radii: `rlist` and `max(rcoulomb,rvdw)`. Usually one builds the neighbor list every 10 time steps or every 20 fs (parameter `nstlist`). In the neighbor list, all interaction pairs that fall within `rlist` are stored. Furthermore, the interactions between pairs that do not fall within `rlist` but do fall within `max(rcoulomb,rvdw)` are computed during NS. The forces and energy are stored separately and added to short-range forces at every time step between successive NS. If `rlist = max(rcoulomb,rvdw)`, no forces are evaluated during neighbor list generation. The virial is calculated from the sum of the short- and long-range forces. This means that the virial can be slightly asymmetrical at non-NS steps. In single precision, the virial is almost always asymmetrical because the off-diagonal elements are about as large as each element in the sum. In most cases this is not really a problem, since the fluctuations in the virial can be 2 orders of magnitude larger than the average.

Except for the plain cut-off, all of the interaction functions in Table 4.2 require that neighbor searching be done with a larger radius than the r_c specified for the functional form, because of the

use of charge groups. The extra radius is typically of the order of 0.25 nm (roughly the largest distance between two atoms in a charge group plus the distance a charge group can diffuse within neighbor list updates).

	Type	Parameters
Coulomb	Plain cut-off	r_c, ϵ_r
	Reaction field	r_c, ϵ_{rf}
	Shift function	r_1, r_c, ϵ_r
	Switch function	r_1, r_c, ϵ_r
VdW	Plain cut-off	r_c
	Shift function	r_1, r_c
	Switch function	r_1, r_c

Table 4.2: Parameters for the different functional forms of the non-bonded interactions.

4.7 Virtual interaction sites

Virtual interaction sites (called dummy atoms in GROMACS versions before 3.3) can be used in GROMACS in a number of ways. We write the position of the virtual site \mathbf{r}_s as a function of the positions of other particles \mathbf{r}_i : $\mathbf{r}_s = f(\mathbf{r}_1.. \mathbf{r}_n)$. The virtual site, which may carry charge or be involved in other interactions, can now be used in the force calculation. The force acting on the virtual site must be redistributed over the particles with mass in a consistent way. A good way to do this can be found in ref. [97]. We can write the potential energy as:

$$V = V(\mathbf{r}_s, \mathbf{r}_1, \dots, \mathbf{r}_n) = V^*(\mathbf{r}_1, \dots, \mathbf{r}_n) \quad (4.131)$$

The force on the particle i is then:

$$\mathbf{F}_i = -\frac{\partial V^*}{\partial \mathbf{r}_i} = -\frac{\partial V}{\partial \mathbf{r}_i} - \frac{\partial V}{\partial \mathbf{r}_s} \frac{\partial \mathbf{r}_s}{\partial \mathbf{r}_i} = \mathbf{F}_i^{direct} + \mathbf{F}'_i \quad (4.132)$$

The first term is the normal force. The second term is the force on particle i due to the virtual site, which can be written in tensor notation:

$$\mathbf{F}'_i = \begin{bmatrix} \frac{\partial x_s}{\partial x_i} & \frac{\partial y_s}{\partial x_i} & \frac{\partial z_s}{\partial x_i} \\ \frac{\partial x_s}{\partial y_i} & \frac{\partial y_s}{\partial y_i} & \frac{\partial z_s}{\partial y_i} \\ \frac{\partial x_s}{\partial z_i} & \frac{\partial y_s}{\partial z_i} & \frac{\partial z_s}{\partial z_i} \end{bmatrix} \mathbf{F}_s \quad (4.133)$$

where \mathbf{F}_s is the force on the virtual site and x_s, y_s and z_s are the coordinates of the virtual site. In this way, the total force and the total torque are conserved [97].

The computation of the virial (eqn. 3.24) is non-trivial when virtual sites are used. Since the virial involves a summation over all the atoms (rather than virtual sites), the forces must be redistributed from the virtual sites to the atoms (using eqn. 4.133) before computation of the virial. In some special cases where the forces on the atoms can be written as a linear combination of the forces on

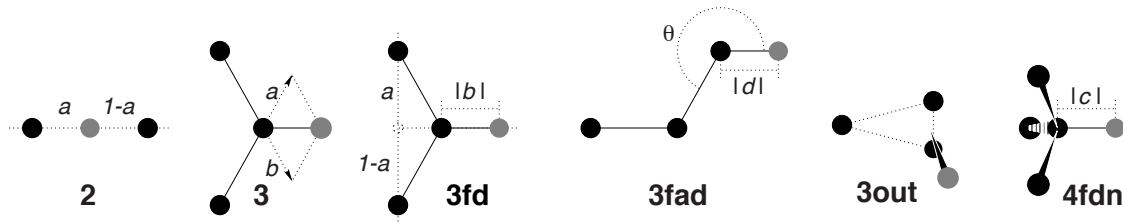

Figure 4.16: The six different types of virtual site construction in GROMACS. The constructing atoms are shown as black circles, the virtual sites in gray.

the virtual sites (types 2 and 3 below) there is no difference between computing the virial before and after the redistribution of forces. However, in the general case redistribution should be done first.

There are six ways to construct virtual sites from surrounding atoms in GROMACS, which we classify by the number of constructing atoms. **Note** that all site types mentioned can be constructed from types 3fd (normalized, in-plane) and 3out (non-normalized, out of plane). However, the amount of computation involved increases sharply along this list, so we strongly recommended using the first adequate virtual site type that will be sufficient for a certain purpose. Fig. 4.16 depicts 6 of the available virtual site constructions. The conceptually simplest construction types are linear combinations:

$$\mathbf{r}_s = \sum_{i=1}^N w_i \mathbf{r}_i \quad (4.134)$$

The force is then redistributed using the same weights:

$$\mathbf{F}_i' = w_i \mathbf{F}_s \quad (4.135)$$

The types of virtual sites supported in GROMACS are given in the list below. Constructing atoms in virtual sites can be virtual sites themselves, but only if they are higher in the list, i.e. virtual sites can be constructed from “particles” that are simpler virtual sites.

2. As a linear combination of two atoms (Fig. 4.16 2):

$$w_i = 1 - a, \quad w_j = a \quad (4.136)$$

In this case the virtual site is on the line through atoms i and j .

3. As a linear combination of three atoms (Fig. 4.16 3):

$$w_i = 1 - a - b, \quad w_j = a, \quad w_k = b \quad (4.137)$$

In this case the virtual site is in the plane of the other three particles.

- 3fd. In the plane of three atoms, with a fixed distance (Fig. 4.16 3fd):

$$\mathbf{r}_s = \mathbf{r}_i + b \frac{\mathbf{r}_{ij} + a\mathbf{r}_{jk}}{|\mathbf{r}_{ij} + a\mathbf{r}_{jk}|} \quad (4.138)$$

In this case the virtual site is in the plane of the other three particles at a distance of $|b|$ from i . The force on particles i , j and k due to the force on the virtual site can be computed as:

$$\begin{aligned} \mathbf{F}'_i &= \mathbf{F}_s - \gamma(\mathbf{F}_s - \mathbf{p}) \\ \mathbf{F}'_j &= (1-a)\gamma(\mathbf{F}_s - \mathbf{p}) \quad \text{where} \\ \mathbf{F}'_k &= a\gamma(\mathbf{F}_s - \mathbf{p}) \end{aligned} \quad \begin{aligned} \gamma &= \frac{b}{|\mathbf{r}_{ij} + a\mathbf{r}_{jk}|} \\ \mathbf{p} &= \frac{\mathbf{r}_{is} \cdot \mathbf{F}_s}{\mathbf{r}_{is} \cdot \mathbf{r}_{is}} \mathbf{r}_{is} \end{aligned} \quad (4.139)$$

3fad. In the plane of three atoms, with a fixed angle and distance (Fig. 4.16 3fad):

$$\mathbf{r}_s = \mathbf{r}_i + d \cos \theta \frac{\mathbf{r}_{ij}}{|\mathbf{r}_{ij}|} + d \sin \theta \frac{\mathbf{r}_\perp}{|\mathbf{r}_\perp|} \quad \text{where} \quad \mathbf{r}_\perp = \mathbf{r}_{jk} - \frac{\mathbf{r}_{ij} \cdot \mathbf{r}_{jk}}{\mathbf{r}_{ij} \cdot \mathbf{r}_{ij}} \mathbf{r}_{ij} \quad (4.140)$$

In this case the virtual site is in the plane of the other three particles at a distance of $|d|$ from i at an angle of α with \mathbf{r}_{ij} . Atom k defines the plane and the direction of the angle. **Note** that in this case b and α must be specified, instead of a and b (see also sec. 5.2.2). The force on particles i , j and k due to the force on the virtual site can be computed as (with \mathbf{r}_\perp as defined in eqn. 4.140):

$$\begin{aligned} \mathbf{F}'_i &= \mathbf{F}_s - \frac{d \cos \theta}{|\mathbf{r}_{ij}|} \mathbf{F}_1 + \frac{d \sin \theta}{|\mathbf{r}_\perp|} \left(\frac{\mathbf{r}_{ij} \cdot \mathbf{r}_{jk}}{\mathbf{r}_{ij} \cdot \mathbf{r}_{ij}} \mathbf{F}_2 + \mathbf{F}_3 \right) \\ \mathbf{F}'_j &= \frac{d \cos \theta}{|\mathbf{r}_{ij}|} \mathbf{F}_1 - \frac{d \sin \theta}{|\mathbf{r}_\perp|} \left(\mathbf{F}_2 + \frac{\mathbf{r}_{ij} \cdot \mathbf{r}_{jk}}{\mathbf{r}_{ij} \cdot \mathbf{r}_{ij}} \mathbf{F}_2 + \mathbf{F}_3 \right) \\ \mathbf{F}'_k &= \frac{d \sin \theta}{|\mathbf{r}_\perp|} \mathbf{F}_2 \end{aligned}$$

$$\text{where } \mathbf{F}_1 = \mathbf{F}_s - \frac{\mathbf{r}_{ij} \cdot \mathbf{F}_s}{\mathbf{r}_{ij} \cdot \mathbf{r}_{ij}} \mathbf{r}_{ij}, \quad \mathbf{F}_2 = \mathbf{F}_1 - \frac{\mathbf{r}_\perp \cdot \mathbf{F}_s}{\mathbf{r}_\perp \cdot \mathbf{r}_\perp} \mathbf{r}_\perp \quad \text{and} \quad \mathbf{F}_3 = \frac{\mathbf{r}_{ij} \cdot \mathbf{F}_s}{\mathbf{r}_{ij} \cdot \mathbf{r}_{ij}} \mathbf{r}_\perp \quad (4.141)$$

3out. As a non-linear combination of three atoms, out of plane (Fig. 4.16 3out):

$$\mathbf{r}_s = \mathbf{r}_i + a\mathbf{r}_{ij} + b\mathbf{r}_{ik} + c(\mathbf{r}_{ij} \times \mathbf{r}_{ik}) \quad (4.142)$$

This enables the construction of virtual sites out of the plane of the other atoms. The force on particles i , j and k due to the force on the virtual site can be computed as:

$$\begin{aligned} \mathbf{F}'_j &= \begin{bmatrix} a & -c z_{ik} & c y_{ik} \\ c z_{ik} & a & -c x_{ik} \\ -c y_{ik} & c x_{ik} & a \end{bmatrix} \mathbf{F}_s \\ \mathbf{F}'_k &= \begin{bmatrix} b & c z_{ij} & -c y_{ij} \\ -c z_{ij} & b & c x_{ij} \\ c y_{ij} & -c x_{ij} & b \end{bmatrix} \mathbf{F}_s \\ \mathbf{F}'_i &= \mathbf{F}_s - \mathbf{F}'_j - \mathbf{F}'_k \end{aligned} \quad (4.143)$$

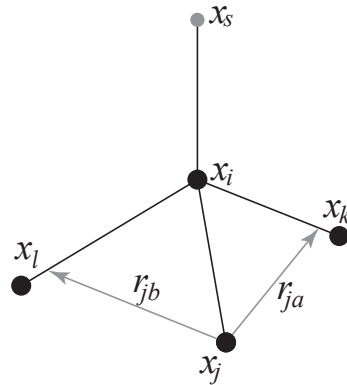

Figure 4.17: The new 4fdn virtual site construction, which is stable even when all constructing atoms are in the same plane.

4fdn. From four atoms, with a fixed distance, see separate Fig. 4.17. This construction is a bit complex, in particular since the previous type (4fd) could be unstable which forced us to introduce a more elaborate construction:

$$\begin{aligned}
 \mathbf{r}_{ja} &= a \mathbf{r}_{ik} - \mathbf{r}_{ij} = a (\mathbf{x}_k - \mathbf{x}_i) - (\mathbf{x}_j - \mathbf{x}_i) \\
 \mathbf{r}_{jb} &= b \mathbf{r}_{il} - \mathbf{r}_{ij} = b (\mathbf{x}_l - \mathbf{x}_i) - (\mathbf{x}_j - \mathbf{x}_i) \\
 \mathbf{r}_m &= \mathbf{r}_{ja} \times \mathbf{r}_{jb} \\
 \mathbf{x}_s &= \mathbf{x}_i + c \frac{\mathbf{r}_m}{|\mathbf{r}_m|}
 \end{aligned} \tag{4.144}$$

In this case the virtual site is at a distance of $|c|$ from i , while a and b are parameters. **Note** that the vectors \mathbf{r}_{ik} and \mathbf{r}_{il} are not normalized to save floating-point operations. The force on particles i , j , k and l due to the force on the virtual site are computed through chain rule derivatives of the construction expression. This is exact and conserves energy, but it does lead to relatively lengthy expressions that we do not include here (over 200 floating-point operations). The interested reader can look at the source code in `vsite.c`. Fortunately, this `vsite` type is normally only used for chiral centers such as C_α atoms in proteins.

The new 4fdn construct is identified with a ‘type’ value of 2 in the topology. The earlier 4fd type is still supported internally (‘type’ value 1), but it should not be used for new simulations. All current GROMACS tools will automatically generate type 4fdn instead.

N. A linear combination of N atoms with relative weights a_i . The weight for atom i is:

$$w_i = a_i \left(\sum_{j=1}^N a_j \right)^{-1} \tag{4.145}$$

There are three options for setting the weights:

COG center of geometry: equal weights

COM center of mass: a_i is the mass of atom i ; when in free-energy simulations the mass of the atom is changed, only the mass of the A-state is used for the weight

COW center of weights: a_i is defined by the user

4.8 Dispersion correction

In this section, we derive long-range corrections due to the use of a cut-off for Lennard-Jones or Buckingham interactions. We assume that the cut-off is so long that the repulsion term can safely be neglected, and therefore only the dispersion term is taken into account. Due to the nature of the dispersion interaction (we are truncating a potential proportional to $-r^{-6}$), energy and pressure corrections are both negative. While the energy correction is usually small, it may be important for free energy calculations where differences between two different Hamiltonians are considered. In contrast, the pressure correction is very large and can not neglected under any circumstances where a correct pressure is required, especially for any pressure simulations. Although it is, in principle, possible to parameterize a force field such that the pressure is close to the desired experimental value without correction, such a method makes the parameterization dependent on the cut-off and is therefore undesirable.

4.8.1 Energy

The long-range contribution of the dispersion interaction to the virial can be derived analytically, if we assume a homogeneous system beyond the cut-off distance r_c . The dispersion energy between two particles is written as:

$$V(r_{ij}) = -C_6 r_{ij}^{-6} \quad (4.146)$$

and the corresponding force is:

$$\mathbf{F}_{ij} = -6 C_6 r_{ij}^{-8} \mathbf{r}_{ij} \quad (4.147)$$

In a periodic system it is not easy to calculate the full potentials, so usually a cut-off is applied, which can be abrupt or smooth. We will call the potential and force with cut-off V_c and \mathbf{F}_c . The long-range contribution to the dispersion energy in a system with N particles and particle density $\rho = N/V$ is:

$$V_{lr} = \frac{1}{2} N \rho \int_0^\infty 4\pi r^2 g(r) (V(r) - V_c(r)) dr \quad (4.148)$$

We will integrate this for the shift function, which is the most general form of van der Waals interaction available in GROMACS. The shift function has a constant difference S from 0 to r_1 and is 0 beyond the cut-off distance r_c . We can integrate eqn. 4.148, assuming that the density in the sphere within r_1 is equal to the global density and the radial distribution function $g(r)$ is 1 beyond r_1 :

$$\begin{aligned} V_{lr} &= \frac{1}{2} N \left(\rho \int_0^{r_1} 4\pi r^2 g(r) C_6 S dr + \rho \int_{r_1}^{r_c} 4\pi r^2 (V(r) - V_c(r)) dr + \rho \int_{r_c}^\infty 4\pi r^2 V(r) dr \right) \\ &= \frac{1}{2} N \left(\left(\frac{4}{3} \pi \rho r_1^3 - 1 \right) C_6 S + \rho \int_{r_1}^{r_c} 4\pi r^2 (V(r) - V_c(r)) dr - \frac{4}{3} \pi N \rho C_6 r_c^{-3} \right) \quad (4.149) \end{aligned}$$

where the term -1 corrects for the self-interaction. For a plain cut-off we only need to assume that $g(r)$ is 1 beyond r_c and the correction reduces to [98]:

$$V_{lr} = -\frac{2}{3}\pi N\rho C_6 r_c^{-3} \quad (4.150)$$

If we consider, for example, a box of pure water, simulated with a cut-off of 0.9 nm and a density of 1 g cm^{-3} this correction is $-0.75 \text{ kJ mol}^{-1}$ per molecule.

For a homogeneous mixture we need to define an *average dispersion constant*:

$$\langle C_6 \rangle = \frac{2}{N(N-1)} \sum_i^N \sum_{j>i}^N C_6(i, j) \quad (4.151)$$

In GROMACS, excluded pairs of atoms do not contribute to the average.

In the case of inhomogeneous simulation systems, *e.g.* a system with a lipid interface, the energy correction can be applied if $\langle C_6 \rangle$ for both components is comparable.

4.8.2 Virial and pressure

The scalar virial of the system due to the dispersion interaction between two particles i and j is given by:

$$\Xi = -\frac{1}{2} \mathbf{r}_{ij} \cdot \mathbf{F}_{ij} = 3 C_6 r_{ij}^{-6} \quad (4.152)$$

The pressure is given by:

$$P = \frac{2}{3V} (E_{kin} - \Xi) \quad (4.153)$$

The long-range correction to the virial is given by:

$$\Xi_{lr} = \frac{1}{2} N\rho \int_0^\infty 4\pi r^2 g(r) (\Xi - \Xi_c) dr \quad (4.154)$$

We can again integrate the long-range contribution to the virial assuming $g(r)$ is 1 beyond r_1 :

$$\begin{aligned} \Xi_{lr} &= \frac{1}{2} N\rho \left(\int_{r_1}^{r_c} 4\pi r^2 (\Xi - \Xi_c) dr + \int_{r_c}^\infty 4\pi r^2 3 C_6 r_{ij}^{-6} dr \right) \\ &= \frac{1}{2} N\rho \left(\int_{r_1}^{r_c} 4\pi r^2 (\Xi - \Xi_c) dr + 4\pi C_6 r_c^{-3} \right) \end{aligned} \quad (4.155)$$

For a plain cut-off the correction to the pressure is [98]:

$$P_{lr} = -\frac{4}{3}\pi C_6 \rho^2 r_c^{-3} \quad (4.156)$$

Using the same example of a water box, the correction to the virial is 0.75 kJ mol^{-1} per molecule, the corresponding correction to the pressure for SPC water is approximately -280 bar .

For homogeneous mixtures, we can again use the average dispersion constant $\langle C_6 \rangle$ (eqn. 4.151):

$$P_{lr} = -\frac{4}{3}\pi \langle C_6 \rangle \rho^2 r_c^{-3} \quad (4.157)$$

For inhomogeneous systems, eqn. 4.157 can be applied under the same restriction as holds for the energy (see sec. 4.8.1).

4.9 Long Range Electrostatics

4.9.1 Ewald summation

The total electrostatic energy of N particles and their periodic images is given by

$$V = \frac{f}{2} \sum_{n_x} \sum_{n_y} \sum_{n_z^*} \sum_i^N \sum_j^N \frac{q_i q_j}{r_{ij,\mathbf{n}}}. \quad (4.158)$$

$(n_x, n_y, n_z) = \mathbf{n}$ is the box index vector, and the star indicates that terms with $i = j$ should be omitted when $(n_x, n_y, n_z) = (0, 0, 0)$. The distance $r_{ij,\mathbf{n}}$ is the real distance between the charges and not the minimum-image. This sum is conditionally convergent, but very slow.

Ewald summation was first introduced as a method to calculate long-range interactions of the periodic images in crystals [99]. The idea is to convert the single slowly-converging sum eqn. 4.158 into two quickly-converging terms and a constant term:

$$V = V_{dir} + V_{rec} + V_0 \quad (4.159)$$

$$V_{dir} = \frac{f}{2} \sum_{i,j}^N \sum_{n_x} \sum_{n_y} \sum_{n_z^*} q_i q_j \frac{\text{erfc}(\beta r_{ij,\mathbf{n}})}{r_{ij,\mathbf{n}}} \quad (4.160)$$

$$V_{rec} = \frac{f}{2\pi V} \sum_{i,j}^N q_i q_j \sum_{m_x} \sum_{m_y} \sum_{m_z^*} \frac{\exp(-(\pi \mathbf{m}/\beta)^2 + 2\pi i \mathbf{m} \cdot (\mathbf{r}_i - \mathbf{r}_j))}{\mathbf{m}^2} \quad (4.161)$$

$$V_0 = -\frac{f\beta}{\sqrt{\pi}} \sum_i^N q_i^2, \quad (4.162)$$

where β is a parameter that determines the relative weight of the direct and reciprocal sums and $\mathbf{m} = (m_x, m_y, m_z)$. In this way we can use a short cut-off (of the order of 1 nm) in the direct space sum and a short cut-off in the reciprocal space sum (*e.g.* 10 wave vectors in each direction). Unfortunately, the computational cost of the reciprocal part of the sum increases as N^2 (or $N^{3/2}$ with a slightly better algorithm) and it is therefore not realistic for use in large systems.

Using Ewald

Don't use Ewald unless you are absolutely sure this is what you want - for almost all cases the PME method below will perform much better. If you still want to employ classical Ewald summation enter this in your `.mdp` file, if the side of your box is about 3 nm:

```
coulombtype      = Ewald
rvdw             = 0.9
rlist           = 0.9
rcoulomb        = 0.9
fourierspacing  = 0.6
ewald-rtol      = 1e-5
```

The ratio of the box dimensions and the `fourierspacing` parameter determines the highest magnitude of wave vectors m_x, m_y, m_z to use in each direction. With a 3-nm cubic box this example would use 11 wave vectors (from -5 to 5) in each direction. The `ewald-rtol` parameter is the relative strength of the electrostatic interaction at the cut-off. Decreasing this gives you a more accurate direct sum, but a less accurate reciprocal sum.

4.9.2 PME

Particle-mesh Ewald is a method proposed by Tom Darden [12] to improve the performance of the reciprocal sum. Instead of directly summing wave vectors, the charges are assigned to a grid using interpolation. The implementation in GROMACS uses cardinal B-spline interpolation [13], which is referred to as smooth PME (SPME). The grid is then Fourier transformed with a 3D FFT algorithm and the reciprocal energy term obtained by a single sum over the grid in k-space.

The potential at the grid points is calculated by inverse transformation, and by using the interpolation factors we get the forces on each atom.

The PME algorithm scales as $N \log(N)$, and is substantially faster than ordinary Ewald summation on medium to large systems. On very small systems it might still be better to use Ewald to avoid the overhead in setting up grids and transforms. For the parallelization of PME see the section on MPMD PME (3.18.5).

With the Verlet cut-off scheme, the PME direct space potential is shifted by a constant such that the potential is zero at the cut-off. This shift is small and since the net system charge is close to zero, the total shift is very small, unlike in the case of the Lennard-Jones potential where all shifts add up. We apply the shift anyhow, such that the potential is the exact integral of the force.

Using PME

To use Particle-mesh Ewald summation in GROMACS, specify the following lines in your `.mdp` file:

```
coulombtype      = PME
rvdw             = 0.9
rlist            = 0.9
rcoulomb        = 0.9
fourierspacing  = 0.12
pme-order       = 4
ewald-rtol      = 1e-5
```

In this case the `fourierspacing` parameter determines the maximum spacing for the FFT grid (i.e. minimum number of grid points), and `pme-order` controls the interpolation order. Using fourth-order (cubic) interpolation and this spacing should give electrostatic energies accurate to about $5 \cdot 10^{-3}$. Since the Lennard-Jones energies are not this accurate it might even be possible to increase this spacing slightly.

Pressure scaling works with PME, but be aware of the fact that anisotropic scaling can introduce artificial ordering in some systems.

4.9.3 P3M-AD

The Particle-Particle Particle-Mesh methods of Hockney & Eastwood can also be applied in GROMACS for the treatment of long range electrostatic interactions [100]. Although the P3M method was the first efficient long-range electrostatics method for molecular simulation, the smooth PME (SPME) method has largely replaced P3M as the method of choice in atomistic simulations. One performance disadvantage of the original P3M method was that it required 3 3D-FFT back transforms to obtain the forces on the particles. But this is not required for P3M and the forces can be derived through analytical differentiation of the potential, as done in PME. The resulting method is termed P3M-AD. The only remaining difference between P3M-AD and PME is the optimization of the lattice Green influence function for error minimization that P3M uses. However, in 2012 it has been shown that the SPME influence function can be modified to obtain P3M [101]. This means that the advantage of error minimization in P3M-AD can be used at the same computational cost and with the same code as PME, just by adding a few lines to modify the influence function. However, at optimal parameter setting the effect of error minimization in P3M-AD is less than 10%. P3M-AD does show large accuracy gains with interlaced (also known as staggered) grids, but that is not supported in GROMACS (yet).

P3M is used in GROMACS with exactly the same options as used with PME by selecting the electrostatics type:

```
coulombtype      = P3M-AD
```

4.9.4 Optimizing Fourier transforms

To get the best possible performance you should try to avoid large prime numbers for grid dimensions. The FFT code used in GROMACS is optimized for grid sizes of the form $2^a 3^b 5^c 7^d 11^e 13^f$, where $e + f$ is 0 or 1 and the other exponents arbitrary. (See further the documentation of the FFT algorithms at www.fftw.org).

It is also possible to optimize the transforms for the current problem by performing some calculations at the start of the run. This is not done by default since it takes a couple of minutes, but for large runs it will save time. Turn it on by specifying

```
optimize-fft     = yes
```

in your `.mdp` file.

When running in parallel, the grid must be communicated several times, thus hurting scaling performance. With PME you can improve this by increasing grid spacing while simultaneously increasing the interpolation to *e.g.* sixth order. Since the interpolation is entirely local, doing so will improve the scaling in most cases.

4.10 Force field

A force field is built up from two distinct components:

- The set of equations (called the *s*) used to generate the potential energies and their derivatives, the forces. These are described in detail in the previous chapter.
- The parameters used in this set of equations. These are not given in this manual, but in the data files corresponding to your GROMACS distribution.

Within one set of equations various sets of parameters can be used. Care must be taken that the combination of equations and parameters form a consistent set. It is in general dangerous to make *ad hoc* changes in a subset of parameters, because the various contributions to the total force are usually interdependent. This means in principle that every change should be documented, verified by comparison to experimental data and published in a peer-reviewed journal before it can be used.

GROMACS 4.6.2 includes several force fields, and additional ones are available on the website. If you do not know which one to select we recommend GROMOS-96 for united-atom setups and OPLS-AA/L for all-atom parameters. That said, we describe the available options in some detail.

4.10.1 GROMOS87

The GROMOS-87 suite of programs and corresponding force field [78] formed the basis for the development of GROMACS in the early 1990s. The original GROMOS87 force field is not available in GROMACS. In previous versions (< 3.3.2) there used to be the so-called “GROMACS force field,” which was based on GROMOS-87 [78], with a small modification concerning the interaction between water oxygens and carbon atoms [102, 103], as well as 10 extra atom types [104, 105, 102, 103, 106]. Whenever using this force field, please cite the above references, and **do not** call it the “GROMACS force field,” instead name it GROMOS-87 [78] with corrections as detailed in [102, 103]. As noted by `pdb2gmx`, this force field is “deprecated,” indicating that newer, perhaps more reliable, versions of this parameter set are available. For backwards compatibility, it is maintained in the current release. Should you have a justifiable reason to use this force field, all necessary files are provided in the `gmx.ff` sub-directory of the GROMACS library. See also the note in 5.2.1.

All-hydrogen force field

The GROMOS-87-based all-hydrogen force field is almost identical to the normal GROMOS-87 force field, since the extra hydrogens have no Lennard-Jones interaction and zero charge. The only differences are in the bond angle and improper dihedral angle terms. This force field is only useful when you need the exact hydrogen positions, for instance for distance restraints derived from NMR measurements. When citing this force field please read the previous paragraph.

4.10.2 GROMOS-96

GROMACS supports the GROMOS-96 force fields [77]. All parameters for the 43A1, 43A2 (development, improved alkane dihedrals), 45A3, 53A5, and 53A6 parameter sets are included. All standard building blocks are included and topologies can be built automatically by `pdb2gmx`.

The GROMOS-96 force field is a further development of the GROMOS-87 force field. It has improvements over the GROMOS-87 force field for proteins and small molecules. **Note** that

the sugar parameters present in 53A6 do correspond to those published in 2004[107], which are different from those present in 45A4, which is not included in GROMACS at this time. The 45A4 parameter set corresponds to a later revision of these parameters. The GROMOS-96 force field is not, however, recommended for use with long alkanes and lipids. The GROMOS-96 force field differs from the GROMOS-87 force field in a few respects:

- the force field parameters
- the parameters for the bonded interactions are not linked to atom types
- a fourth power bond stretching potential (4.2.1)
- an angle potential based on the cosine of the angle (4.2.6)

There are two differences in implementation between GROMACS and GROMOS-96 which can lead to slightly different results when simulating the same system with both packages:

- in GROMOS-96 neighbor searching for solvents is performed on the first atom of the solvent molecule. This is not implemented in GROMACS, but the difference with searching by centers of charge groups is very small
- the virial in GROMOS-96 is molecule-based. This is not implemented in GROMACS, which uses atomic virials

The GROMOS-96 force field was parameterized with a Lennard-Jones cut-off of 1.4 nm, so be sure to use a Lennard-Jones cut-off (r_{vdw}) of at least 1.4. A larger cut-off is possible because the Lennard-Jones potential and forces are almost zero beyond 1.4 nm.

GROMOS-96 files

GROMACS can read and write GROMOS-96 coordinate and trajectory files. These files should have the extension `.g96`. Such a file can be a GROMOS-96 initial/final configuration file, a coordinate trajectory file, or a combination of both. The file is fixed format; all floats are written as 15.9, and as such, files can get huge. GROMACS supports the following data blocks in the given order:

- Header block:

```
TITLE (mandatory)
```

- Frame blocks:

```
TIMESTEP (optional)
POSITION/POSITIONRED (mandatory)
VELOCITY/VELOCITYRED (optional)
BOX (optional)
```

See the GROMOS-96 manual [77] for a complete description of the blocks. **Note** that all GROMACS programs can read compressed (`.Z`) or gzipped (`.gz`) files.

4.10.3 OPLS/AA

4.10.4 AMBER

As of version 4.5, GROMACS provides native support for the following AMBER force fields:

- AMBER94 [108]
- AMBER96 [109]
- AMBER99 [110]
- AMBER99SB [111]
- AMBER99SB-ILDN [112]
- AMBER03 [113]
- AMBERGS [114]

4.10.5 CHARMM

As of version 4.5, GROMACS supports the CHARMM27 force field for proteins [115, 116], lipids [117] and nucleic acids [118]. The protein parameters (and to some extent the lipid and nucleic acid parameters) were thoroughly tested – both by comparing potential energies between the port and the standard parameter set in the CHARMM molecular simulation package, as well by how the protein force field behaves together with GROMACS-specific techniques such as virtual sites (enabling long time steps) and a fast implicit solvent recently implemented [72] – and the details and results are presented in the paper by Bjelkmar et al. [119]. The nucleic acid parameters, as well as the ones for HEME, were converted and tested by Michel Cuendet.

When selecting the CHARMM force field in `pdb2gmx` the default option is to use CMAP (for torsional correction map). To exclude CMAP, use `-nocmap`. The basic form of the CMAP term implemented in GROMACS is a function of the ϕ and ψ backbone torsion angles. This term is defined in the `.rtp` file by a `[cmap]` statement at the end of each residue supporting CMAP. The following five atom names define the two torsional angles. Atoms 1-4 define ϕ , and atoms 2-5 define ψ . The corresponding atom types are then matched to the correct CMAP type in the `cmap.itp` file that contains the correction maps.

4.10.6 Coarse-grained force-fields

Coarse-graining is a systematic way of reducing the number of degrees of freedom representing a system of interest. To achieve this, typically whole groups of atoms are represented by single beads and the coarse-grained force fields describes their effective interactions. Depending on the choice of parameterization, the functional form of such an interaction can be complicated and often tabulated potentials are used.

Coarse-grained models are designed to reproduce certain properties of a reference system. This can be either a full atomistic model or even experimental data. Depending on the properties to

reproduce there are different methods to derive such force fields. An incomplete list of methods is given below:

- Conserving free energies
 - Simplex method
 - MARTINI force-field (see next section)
- Conserving distributions (like the radial distribution function), so-called structure-based coarse-graining
 - (iterative) Boltzmann inversion
 - Inverse Monte Carlo
- Conserving forces
 - Force matching

Note that coarse-grained potentials are state dependent (e.g. temperature, density,...) and should be re-parametrized depending on the system of interest and the simulation conditions. This can for example be done using the Versatile Object-oriented Toolkit for Coarse-Graining Applications (VOTCA) [120]. The package was designed to assist in systematic coarse-graining, provides implementations for most of the algorithms mentioned above and has a well tested interface to GROMACS. It is available as open source and further information can be found at www.votca.org.

4.10.7 MARTINI

The MARTINI force field is a coarse-grain parameter set that allows for the construction of many systems, including proteins and membranes.

4.10.8 PLUM

The PLUM force field [121] is an example of a solvent-free protein-membrane model for which the membrane was derived from structure-based coarse-graining [122]. A GROMACS implementation can be found at code.google.com/p/plumx.

Chapter 5

Topologies

5.1 Introduction

GROMACS must know on which atoms and combinations of atoms the various contributions to the potential functions (see chapter 4) must act. It must also know what parameters must be applied to the various functions. All this is described in the *topology* file `*.top`, which lists the *constant attributes* of each atom. There are many more atom types than elements, but only atom types present in biological systems are parameterized in the force field, plus some metals, ions and silicon. The bonded and special interactions are determined by fixed lists that are included in the topology file. Certain non-bonded interactions must be excluded (first and second neighbors), as these are already treated in bonded interactions. In addition, there are *dynamic attributes* of atoms - their positions, velocities and forces. These do not strictly belong to the molecular topology, and are stored in the coordinate file `*.gro` (positions and velocities), or trajectory file `*.trr` (positions, velocities, forces).

This chapter describes the setup of the topology file, the `*.top` file and the database files: what the parameters stand for and how/where to change them if needed. First, all file formats are explained. Section 5.8.1 describes the organization of the files in each force field.

Note: if you construct your own topologies, we encourage you to upload them to our topology archive at www.gromacs.org! Just imagine how thankful you'd have been if your topology had been available there before you started. The same goes for new force fields or modified versions of the standard force fields - contribute them to the force field archive!

5.2 Particle type

In GROMACS, there are three types of particles, see Table 5.1. Only regular atoms and virtual interaction sites are used in GROMACS; shells are necessary for polarizable models like the Shell-Water models [42].

Particle	Symbol
atoms	A
shells	S
virtual interaction sites	V (or D)

Table 5.1: Particle types in GROMACS

5.2.1 Atom types

Each force field defines a set of atom types, which have a characteristic name or number, and mass (in a.m.u.). These listings are found in the `atomtypes.atp` file (`.atp` = **atom type** parameter file). Therefore, it is in this file that you can begin to change and/or add an atom type. A sample from the deprecated `gmx.ff` force field is listed below.

```

O 15.99940 ; carbonyl oxygen (C=O)
OM 15.99940 ; carboxyl oxygen (CO-)
OA 15.99940 ; hydroxyl oxygen (OH)
OW 15.99940 ; water oxygen
N 14.00670 ; peptide nitrogen (N or NH)
NT 14.00670 ; terminal nitrogen (NH2)
NL 14.00670 ; terminal nitrogen (NH3)
NR5 14.00670 ; aromatic N (5-ring, 2 bonds)
NR5* 14.00670 ; aromatic N (5-ring, 3 bonds)
NP 14.00670 ; porphyrin nitrogen
C 12.01100 ; bare carbon (peptide, C=O, C-N)
CH1 13.01900 ; aliphatic CH-group
CH2 14.02700 ; aliphatic CH2-group
CH3 15.03500 ; aliphatic CH3-group

```

Note: GROMACS makes use of the atom types as a name, *not* as a number (as *e.g.* in GROMOS).

5.2.2 Virtual sites

Some force fields use virtual interaction sites (interaction sites that are constructed from other particle positions) on which certain interactions are located (*e.g.* on benzene rings, to reproduce the correct quadrupole). This is described in sec. 4.7.

To make virtual sites in your system, you should include a section `[virtual_sites?]` (for backward compatibility the old name `[dummies?]` can also be used) in your topology file, where the ‘?’ stands for the number constructing particles for the virtual site. This will be ‘2’ for type 2, ‘3’ for types 3, 3fd, 3fad and 3out and ‘4’ for type 4fdn. The last of these replace an older 4fd type (with the ‘type’ value 1) that could occasionally be unstable; while it is still supported internally in the code, the old 4fd type should not be used in new input files. The different types are explained in sec. 4.7.

Parameters for type 2 should look like this:

```
[ virtual_sites2 ]
```

```
; Site from      funct a
5      1      2      1      0.7439756
```

for type 3 like this:

```
[ virtual_sites3 ]
; Site from      funct a      b
5      1      2      3      1      0.7439756  0.128012
```

for type 3fd like this:

```
[ virtual_sites3 ]
; Site from      funct a      d
5      1      2      3      2      0.5      -0.105
```

for type 3fad like this:

```
[ virtual_sites3 ]
; Site from      funct theta    d
5      1      2      3      3      120      0.5
```

for type 3out like this:

```
[ virtual_sites3 ]
; Site from      funct a      b      c
5      1      2      3      4      -0.4      -0.4      6.9281
```

for type 4fdn like this:

```
[ virtual_sites4 ]
; Site from      funct a      b      c
5      1      2      3      4      2      1.0      0.9      0.105
```

This will result in the construction of a virtual site, number 5 (first column ‘Site’), based on the positions of the atoms whose indices are 1 and 2 or 1, 2 and 3 or 1, 2, 3 and 4 (next two, three or four columns ‘from’) following the rules determined by the function number (next column ‘funct’) with the parameters specified (last one, two or three columns ‘a b . .’). Obviously, the atom numbers (including virtual site number) depend on the molecule. It may be instructive to study the topologies for TIP4P or TIP5P water models that are included with the GROMACS distribution.

Note that if any constant bonded interactions are defined between virtual sites and/or normal atoms, they will be removed by `grompp` (unless the option `tt -normvsbds` is used). This removal of bonded interactions is done after generating exclusions, as the generation of exclusions is based on “chemically” bonded interactions.

Virtual sites can be constructed in a more generic way using basic geometric parameters. The directive that can be used is `[virtual_sitesn]`. Required parameters are listed in Table 5.5. An example entry for defining a virtual site at the center of geometry of a given set of atoms might be:

```
[ virtual_sitesn ]
; Site  funct  from
5      1      1      2      3      4
```

Property	Symbol	Unit
Type	-	-
Mass	m	a.m.u.
Charge	q	electron
epsilon	ϵ	kJ/mol
sigma	σ	nm

Table 5.2: Static atom type properties in GROMACS

5.3 Parameter files

5.3.1 Atoms

The *static* properties (see Table 5.2) assigned to the atom types are assigned based on data in several places. The mass is listed in `atomtypes.atp` (see 5.2.1), whereas the charge is listed in `*.rtp` (`.rtp` = **r**esidue **t**opology **p**arameter file, see 5.6.1). This implies that the charges are only defined in the building blocks of amino acids, nucleic acids or otherwise, as defined by the user. When generating a topology (`*.top`) using the `pdb2gmx` program, the information from these files is combined.

5.3.2 Non-bonded parameters

The non-bonded parameters consist of the van der Waals parameters V (`c6` or σ , depending on the combination rule) and W (`c12` or ϵ), as listed in the file `ffnonbonded.itp`, where `p`type is the particle type (see Table 5.1). As with the bonded parameters, entries in `[*type]` directives are applied to their counterparts in the topology file. Missing parameters generate warnings, except as noted below in section 5.3.4.

```
[ atomtypes ]
;name  at.num      mass      charge  ptype      V(c6)      W(c12)
  O      8  15.99940    0.000    A    0.22617E-02  0.74158E-06
  OM     8  15.99940    0.000    A    0.22617E-02  0.74158E-06
  .....

[ nonbond_params ]
; i    j  func      V(c6)      W(c12)
  O    O    1  0.22617E-02  0.74158E-06
  O    OA   1  0.22617E-02  0.13807E-05
  .....
```

Note that most of the included force fields also include the `at.num.` column, but this same information is implied in the OPLS-AA `bond_type` column. The interpretation of the parameters V and W depends on the combination rule that was chosen in the `[defaults]` section of the topology file (see 5.7.1):

$$\text{for combination rule 1 : } \begin{aligned} V_{ii} &= C_i^{(6)} = 4 \epsilon_i \sigma_i^6 \quad [\text{kJ mol}^{-1} \text{ nm}^6] \\ W_{ii} &= C_i^{(12)} = 4 \epsilon_i \sigma_i^{12} \quad [\text{kJ mol}^{-1} \text{ nm}^{12}] \end{aligned} \quad (5.1)$$

$$\begin{aligned} \text{for combination rules 2 and 3 :} \quad V_{ii} &= \sigma_i \text{ [nm]} \\ W_{ii} &= \epsilon_i \text{ [kJ mol}^{-1} \text{]} \end{aligned} \quad (5.2)$$

Some or all combinations for different atom types can be given in the [nonbond_params] section, again with parameters V and W as defined above. Any combination that is not given will be computed from the parameters for the corresponding atom types, according to the combination rule:

$$\begin{aligned} \text{for combination rules 1 and 3 :} \quad C_{ij}^{(6)} &= \left(C_i^{(6)} C_j^{(6)} \right)^{\frac{1}{2}} \\ C_{ij}^{(12)} &= \left(C_i^{(12)} C_j^{(12)} \right)^{\frac{1}{2}} \end{aligned} \quad (5.3)$$

$$\begin{aligned} \text{for combination rule 2 :} \quad \sigma_{ij} &= \frac{1}{2}(\sigma_i + \sigma_j) \\ \epsilon_{ij} &= \sqrt{\epsilon_i \epsilon_j} \end{aligned} \quad (5.4)$$

When σ and ϵ need to be supplied (rules 2 and 3), it would seem it is impossible to have a non-zero C^{12} combined with a zero C^6 parameter. However, providing a negative σ will do exactly that, such that C^6 is set to zero and C^{12} is calculated normally. This situation represents a special case in reading the value of σ , and nothing more.

There is only one set of combination rules for Buckingham potentials:

$$\begin{aligned} A_{ij} &= (A_{ii} A_{jj})^{1/2} \\ B_{ij} &= 2 / \left(\frac{1}{B_{ii}} + \frac{1}{B_{jj}} \right) \\ C_{ij} &= (C_{ii} C_{jj})^{1/2} \end{aligned} \quad (5.5)$$

5.3.3 Bonded parameters

The bonded parameters (*i.e.* bonds, bond angles, improper and proper dihedrals) are listed in `ffbonded.itp`. The entries in this database describe, respectively, the atom types in the interactions, the type of the interaction, and the parameters associated with that interaction. These parameters are then read by `grompp` when processing a topology and applied to the relevant bonded parameters, *i.e.* `bondtypes` are applied to entries in the [bonds] directive, etc. Any bonded parameter that is missing from the relevant [*type] directive generates a fatal error. The types of interactions are listed in Table 5.5. Example excerpts from such files follow:

```
[ bondtypes ]
; i      j func          b0          kb
  C      O      1      0.12300      502080.
  C      OM     1      0.12500      418400.
  .....

[ angletypes ]
; i      j      k func          th0          cth
  HO     OA     C      1      109.500      397.480
  HO     OA     CH1    1      109.500      397.480
  .....

[ dihedraltypes ]
```

```

; i      l func          q0          cq
NR5*   NR5      2      0.000      167.360
NR5*   NR5*     2      0.000      167.360
.....

[ dihedraltypes ]
; j      k func          phi0          cp      mult
  C     OA      1     180.000      16.736      2
  C     N       1     180.000      33.472      2
.....

[ dihedraltypes ]
;
; Ryckaert-Bellemans Dihedrals
;
; aj      ak      funct
CP2      CP2      3          9.2789  12.156  -13.120  -3.0597  26.240  -31.495

```

In the `ffbonded.itp` file, you can add bonded parameters. If you want to include parameters for new atom types, make sure you define them in `atomtypes.atp` as well.

5.3.4 Intramolecular pair interactions

Extra Lennard-Jones and electrostatic interactions between pairs of atoms in a molecule can be added in the `[pairs]` section of a molecule definition. The parameters for these interactions can be set independently from the non-bonded interaction parameters. In the GROMOS force fields, pairs are only used to modify the 1-4 interactions (interactions of atoms separated by three bonds). In these force fields the 1-4 interactions are excluded from the non-bonded interactions (see sec. 5.4).

```

[ pairtypes ]
; i      j func          cs6          cs12 ; THESE ARE 1-4 INTERACTIONS
  O     O      1 0.22617E-02  0.74158E-06
  O     OM     1 0.22617E-02  0.74158E-06
.....

```

The pair interaction parameters for the atom types in `ffnonbonded.itp` are listed in the `[pairtypes]` section. The GROMOS force fields list all these interaction parameters explicitly, but this section might be empty for force fields like OPLS that calculate the 1-4 interactions by uniformly scaling the parameters. Pair parameters that are not present in the `[pairtypes]` section are only generated when `gen-pairs` is set to “yes” in the `[defaults]` directive of `forcefield.itp` (see 5.7.1). When `gen-pairs` is set to “no,” `grompp` will give a warning for each pair type for which no parameters are given.

The normal pair interactions, intended for 1-4 interactions, have function type 1. Function type 2 and the `[pairs_nb]` are intended for free-energy simulations. When determining hydration free energies, the solute needs to be decoupled from the solvent. This can be done by adding a

B-state topology (see sec. 3.12) that uses zero for all solute non-bonded parameters, *i.e.* charges and LJ parameters. However, the free energy difference between the A and B states is not the total hydration free energy. One has to add the free energy for reintroducing the internal Coulomb and LJ interactions in the solute when in vacuum. This second step can be combined with the first step when the Coulomb and LJ interactions within the solute are not modified. For this purpose, there is a pairs function type 2, which is identical to function type 1, except that the B-state parameters are always identical to the A-state parameters. For searching the parameters in the [pairtypes] section, no distinction is made between function type 1 and 2. The pairs section [pairs_nb] is intended to replace the non-bonded interaction. It uses the unscaled charges and the non-bonded LJ parameters; it also only uses the A-state parameters. **Note** that one should add exclusions for all atom pairs listed in [pairs_nb], otherwise such pairs will also end up in the normal neighbor lists.

Alternatively, this same behavior can be achieved without ever touching the topology, by using the couple-moltype, couple-lambda0, couple-lambda1, and couple-intramol keywords. See sections sec. 3.12 and sec. 6.1 for more information.

All three pair types always use plain Coulomb interactions, even when Reaction-field, PME, Ewald or shifted Coulomb interactions are selected for the non-bonded interactions. Energies for types 1 and 2 are written to the energy and log file in separate “LJ-14” and “Coulomb-14” entries per energy group pair. Energies for [pairs_nb] are added to the “LJ-(SR)” and “Coulomb-(SR)” terms.

5.3.5 Implicit solvation parameters

Starting with GROMACS 4.5, implicit solvent is supported. A section in the topology has been introduced to list those parameters:

```
[ implicit_genborn_params ]
; Atomtype sar st pi gbr hct
NH1 0.155 1 1.028 0.17063 0.79 ; N
N 0.155 1 1 0.155 0.79 ; Proline backbone N
H 0.1 1 1 0.115 0.85 ; H
CT1 0.180 1 1.276 0.190 0.72 ; C
```

In this example the atom type is listed first, followed by five numbers, and a comment (following a semicolon).

Values in columns 1-3 are not currently used. They pertain to more elaborate surface area algorithms, the one from Qiu *et al.* [69] in particular. Column 4 contains the atomic van der Waals radii, which are used in computing the Born radii. The dielectric offset is specified in the *.mdp file, and gets subtracted from the input van der Waals radii for the different Born radii methods, as described by Onufriev *et al.* [71]. Column 5 is the scale factor for the HCT and OBC models. The values are taken from the Tinker implementation of the HCT pairwise scaling method [70]. This method has been modified such that the scaling factors have been adjusted to minimize differences between analytical surface areas and GB using the HCT algorithm. The scaling is further modified in that it is not applied pairwise as proposed by Hawkins *et al.* [70], but on a per-atom (rather than a per-pair) basis.

5.4 Exclusions

The exclusions for non-bonded interactions are generated by `grompp` for neighboring atoms up to a certain number of bonds away, as defined in the `[moleculetype]` section in the topology file (see 5.7.1). Particles are considered bonded when they are connected by “chemical” bonds (`[bonds]` types 1 to 5, 7 or 8) or constraints (`[constraints]` type 1). Type 5 `[bonds]` can be used to create a connection between two atoms without creating an interaction. There is a harmonic interaction (`[bonds]` type 6) that does not connect the atoms by a chemical bond. There is also a second constraint type (`[constraints]` type 2) that fixes the distance, but does not connect the atoms by a chemical bond. For a complete list of all these interactions, see Table 5.5.

Extra exclusions within a molecule can be added manually in a `[exclusions]` section. Each line should start with one atom index, followed by one or more atom indices. All non-bonded interactions between the first atom and the other atoms will be excluded.

When all non-bonded interactions within or between groups of atoms need to be excluded, is it more convenient and much more efficient to use energy monitor group exclusions (see sec. 3.3).

5.5 Constraint algorithms

Constraints are defined in the `[constraints]` section. The format is two atom numbers followed by the function type, which can be 1 or 2, and the constraint distance. The only difference between the two types is that type 1 is used for generating exclusions and type 2 is not (see sec. 5.4). The distances are constrained using the LINCS or the SHAKE algorithm, which can be selected in the `*.mdp` file. Both types of constraints can be perturbed in free-energy calculations by adding a second constraint distance (see 5.7.5). Several types of bonds and angles (see Table 5.5) can be converted automatically to constraints by `grompp`. There are several options for this in the `*.mdp` file.

We have also implemented the SETTLE algorithm [44], which is an analytical solution of SHAKE, specifically for water. SETTLE can be selected in the topology file. See, for instance, the SPC molecule definition:

```
[ moleculetype ]
; molname      nrexcl
SOL            1

[ atoms ]
; nr   at  type  res  nr   ren  nm   at  nm   cg  nr   charge
1     OW      1    SOL   OW1   1    -0.82
2     HW      1    SOL   HW2   1    0.41
3     HW      1    SOL   HW3   1    0.41

[ settles ]
; OW      funct  doh    dhh
1         1     0.1    0.16333
```

```
[ exclusions ]
1      2      3
2      1      3
3      1      2
```

The `[settles]` directive defines the first atom of the water molecule. The `settle` funct is always 1, and the distance between O-H and H-H distances must be given. **Note** that the algorithm can also be used for TIP3P and TIP4P [104]. TIP3P just has another geometry. TIP4P has a virtual site, but since that is generated it does not need to be shaken (nor stirred).

5.6 *pdb2gmx* input files

The GROMACS program `pdb2gmx` generates a topology for the input coordinate file. Several formats are supported for that coordinate file, but `*.pdb` is the most commonly-used format (hence the name `pdb2gmx`). `pdb2gmx` searches for force fields in sub-directories of the GROMACS `share/top` directory and your working directory. Force fields are recognized from the file `forcefield.itp` in a directory with the extension `.ff`. The file `forcefield.doc` may be present, and if so, its first line will be used by `pdb2gmx` to present a short description to the user to help in choosing a force field. Otherwise, the user can choose a force field with the `-ff xxx` command-line argument to `pdb2gmx`, which indicates that a force field in a `xxx.ff` directory is desired. `pdb2gmx` will search first in the working directory, then in the GROMACS `share/top` directory, and use the first matching `xxx.ff` directory found.

Two general files are read by `pdb2gmx`: an atom type file (extension `.atp`, see 5.2.1) from the force field directory, and a file called `residuetypes.dat` from either the working directory, or the GROMACS `share/top` directory. `residuetypes.dat` determines which residue names are considered protein, DNA, RNA, water, and ions.

`pdb2gmx` can read one or multiple databases with topological information for different types of molecules. A set of files belonging to one database should have the same basename, preferably telling something about the type of molecules (*e.g.* `aminoacids`, `rna`, `dna`). The possible files are:

- `<basename>.rtf`
- `<basename>.r2b` (optional)
- `<basename>.arn` (optional)
- `<basename>.hdb` (optional)
- `<basename>.n.tdb` (optional)
- `<basename>.c.tdb` (optional)

Only the `.rtf` file, which contains the topologies of the building blocks, is mandatory. Information from other files will only be used for building blocks that come from an `.rtf` file with the same base name. The user can add building blocks to a force field by having additional files with the same base name in their working directory. By default, only extra building blocks can be defined, but calling `pdb2gmx` with the `-rtfo` option will allow building blocks in a local file to replace the default ones in the force field.

5.6.1 Residue database

The files holding the residue databases have the extension `.rtp`. Originally this file contained building blocks (amino acids) for proteins, and is the GROMACS interpretation of the `rt37c4.dat` file of GROMOS. So the residue database file contains information (bonds, charges, charge groups, and improper dihedrals) for a frequently-used building block. It is better *not* to change this file because it is standard input for `pdb2gmx`, but if changes are needed make them in the `*.top` file (see 5.7.1), or in a `.rtp` file in the working directory as explained in sec. 5.6. Defining topologies of new small molecules is probably easier by writing an include topology file `*.itp` directly. This will be discussed in section 5.7.2. When adding a new protein residue to the database, don't forget to add the residue name to the `residuetypes.dat` file, so that `grompp`, `make_ndx` and analysis tools can recognize the residue as a protein residue (see 8.1.1).

The `.rtp` files are only used by `pdb2gmx`. As mentioned before, the only extra information this program needs from the `.rtp` database is bonds, charges of atoms, charge groups, and improper dihedrals, because the rest is read from the coordinate input file. Some proteins contain residues that are not standard, but are listed in the coordinate file. You have to construct a building block for this “strange” residue, otherwise you will not obtain a `*.top` file. This also holds for molecules in the coordinate file such as ligands, polyatomic ions, crystallization co-solvents, etc. The residue database is constructed in the following way:

```
[ bondedtypes ] ; mandatory
; bonds  angles  dihedrals  impropers
    1      1      1          2 ; mandatory

[ GLY ] ; mandatory

[ atoms ] ; mandatory
; name  type  charge  chargegroup
    N    N   -0.280    0
    H    H    0.280    0
    CA   CH2   0.000    1
    C    C    0.380    2
    O    O   -0.380    2

[ bonds ] ; optional
;atom1 atom2      b0      kb
    N    H
    N    CA
    CA   C
    C    O
    -C   N

[ exclusions ] ; optional
;atom1 atom2

[ angles ] ; optional
;atom1 atom2 atom3  th0    cth

[ dihedrals ] ; optional
```

```

;atom1 atom2 atom3 atom4  phi0      cp      mult

[ impropers ] ; optional
;atom1 atom2 atom3 atom4      q0      cq
      N      -C      CA      H
      -C     -CA      N      -O

[ ZN ]

[ atoms ]
      ZN      ZN      2.000      0

```

The file is free format; the only restriction is that there can be at most one entry on a line. The first field in the file is the `[bondedtypes]` field, which is followed by four numbers, indicating the interaction type for bonds, angles, dihedrals, and improper dihedrals. The file contains residue entries, which consist of atoms and (optionally) bonds, angles, dihedrals, and impropers. The charge group codes denote the charge group numbers. Atoms in the same charge group should always be ordered consecutively. When using the hydrogen database with `pdb2gmx` for adding missing hydrogens (see 5.6.4), the atom names defined in the `.rtp` entry should correspond exactly to the naming convention used in the hydrogen database. The atom names in the bonded interaction can be preceded by a minus or a plus, indicating that the atom is in the preceding or following residue respectively. Explicit parameters added to bonds, angles, dihedrals, and impropers override the standard parameters in the `.itp` files. This should only be used in special cases. Instead of parameters, a string can be added for each bonded interaction. This is used in GROMOS-96 `.rtp` files. These strings are copied to the topology file and can be replaced by force field parameters by the C-preprocessor in `grompp` using `#define` statements.

`pdb2gmx` automatically generates all angles. This means that for the `gmx.ff` force field, the `[angles]` field is only useful for overriding `.itp` parameters. For the GROMOS-96 force field the interaction number of all angles need to be specified.

`pdb2gmx` automatically generates one proper dihedral for every rotatable bond, preferably on heavy atoms. When the `[dihedrals]` field is used, no other dihedrals will be generated for the bonds corresponding to the specified dihedrals. It is possible to put more than one dihedral function on a rotatable bond.

`pdb2gmx` sets the number of exclusions to 3, which means that interactions between atoms connected by at most 3 bonds are excluded. Pair interactions are generated for all pairs of atoms that are separated by 3 bonds (except pairs of hydrogens). When more interactions need to be excluded, or some pair interactions should not be generated, an `[exclusions]` field can be added, followed by pairs of atom names on separate lines. All non-bonded and pair interactions between these atoms will be excluded.

5.6.2 Residue to building block database

Each force field has its own naming convention for residues. Most residues have consistent naming, but some, especially those with different protonation states, can have many different names. The `.r2b` files are used to convert standard residue names to the force field build block names. If no `.r2b` is present in the force field directory or a residue is not listed, the building block name is

ARG	protonated arginine
ARGN	neutral arginine
ASP	negatively charged aspartic acid
ASPH	neutral aspartic acid
CYS	neutral cysteine
CYS2	cysteine with sulfur bound to another cysteine or a heme
GLU	negatively charged glutamic acid
GLUH	neutral glutamic acid
HISD	neutral histidine with N_{δ} protonated
HISE	neutral histidine with N_{ϵ} protonated
HISH	positive histidine with both N_{δ} and N_{ϵ} protonated
HIS1	histidine bound to a heme
LYSN	neutral lysine
LYS	protonated lysine
HEME	heme

Table 5.3: Internal GROMACS residue naming convention.

assumed to be identical to the residue name. The `.r2b` can contain 2 or 5 columns. The 2-column format has the residue name in the first column and the building block name in the second. The 5-column format has 3 additional columns with the building block for the residue occurring in the N-terminus, C-terminus and both termini at the same time (single residue molecule). This is useful for, for instance, the AMBER force fields. If one or more of the terminal versions are not present, a dash should be entered in the corresponding column.

There is a GROMACS naming convention for residues which is only apparent (except for the `pdb2gmx` code) through the `.r2b` file and `specbond.dat` files. This convention is only of importance when you are adding residue types to an `.rtp` file. The convention is listed in Table 5.3. For special bonds with, for instance, a heme group, the GROMACS naming convention is introduced through `specbond.dat` (see 5.6.7), which can subsequently be translated by the `.r2b` file, if required.

5.6.3 Atom renaming database

Force fields often use atom names that do not follow IUPAC or PDB convention. The `.arn` database is used to translate the atom names in the coordinate file to the force field names. Atoms that are not listed keep their names. The file has three columns: the building block name, the old atom name, and the new atom name, respectively. The residue name supports question-mark wildcards that match a single character.

An additional general atom renaming file called `xlateat.dat` is present in the `share/top` directory, which translates common non-standard atom names in the coordinate file to IUPAC/PDB convention. Thus, when writing force field files, you can assume standard atom names and no further atom name translation is required, except for translating from standard atom names to the force field ones.

5.6.4 Hydrogen database

The hydrogen database is stored in `.hdb` files. It contains information for the `pdb2gmx` program on how to connect hydrogen atoms to existing atoms. In versions of the database before GRO-MACS 3.3, hydrogen atoms were named after the atom they are connected to: the first letter of the atom name was replaced by an 'H.' In the versions from 3.3 onwards, the H atom has to be listed explicitly, because the old behavior was protein-specific and hence could not be generalized to other molecules. If more than one hydrogen atom is connected to the same atom, a number will be added to the end of the hydrogen atom name. For example, adding two hydrogen atoms to ND2 (in asparagine), the hydrogen atoms will be named HD21 and HD22. This is important since atom naming in the `.rtp` file (see 5.6.1) must be the same. The format of the hydrogen database is as follows:

```
; res      # additions
          # H add type      H      i      j      k
ALA       1
          1      1      H      N      -C      CA
ARG       4
          1      2      H      N      CA      C
          1      1      HE     NE     CD     CZ
          2      3      HH1    NH1    CZ     NE
          2      3      HH2    NH2    CZ     NE
```

On the first line we see the residue name (ALA or ARG) and the number of kinds of hydrogen atoms that may be added to this residue by the hydrogen database. After that follows one line for each addition, on which we see:

- The number of H atoms added
- The method for adding H atoms, which can be any of:
 - 1 *one planar hydrogen, e.g. rings or peptide bond*
One hydrogen atom (n) is generated, lying in the plane of atoms (i,j,k) on the plane bisecting angle (j-i-k) at a distance of 0.1 nm from atom i, such that the angles (n-i-j) and (n-i-k) are $> 90^\circ$.
 - 2 *one single hydrogen, e.g. hydroxyl*
One hydrogen atom (n) is generated at a distance of 0.1 nm from atom i, such that angle (n-i-j)=109.5 degrees and dihedral (n-i-j-k)=trans.
 - 3 *two planar hydrogens, e.g. ethylene -C=CH₂, or amide -C(=O)NH₂*
Two hydrogens (n1,n2) are generated at a distance of 0.1 nm from atom i, such that angle (n1-i-j)=(n2-i-j)=120 degrees and dihedral (n1-i-j-k)=cis and (n2-i-j-k)=trans, such that names are according to IUPAC standards [123].
 - 4 *two or three tetrahedral hydrogens, e.g. -CH₃*
Three (n1,n2,n3) or two (n1,n2) hydrogens are generated at a distance of 0.1 nm from atom i, such that angle (n1-i-j)=(n2-i-j)=(n3-i-j)=109.47°, dihedral (n1-i-j-k)=trans, (n2-i-j-k)=trans+120 and (n3-i-j-k)=trans+240°.

5 *one tetrahedral hydrogen, e.g. C₃CH*

One hydrogen atom (n') is generated at a distance of 0.1 nm from atom i in tetrahedral conformation such that angle (n'-i-j)=(n'-i-k)=(n'-i-l)=109.47°.

6 *two tetrahedral hydrogens, e.g. C-CH₂-C*

Two hydrogen atoms (n1,n2) are generated at a distance of 0.1 nm from atom i in tetrahedral conformation on the plane bisecting angle j-i-k with angle (n1-i-n2)=(n1-i-j)=(n1-i-k)=109.47°.

7 *two water hydrogens*

Two hydrogens are generated around atom i according to SPC [80] water geometry. The symmetry axis will alternate between three coordinate axes in both directions.

10 *three water "hydrogens"*

Two hydrogens are generated around atom i according to SPC [80] water geometry. The symmetry axis will alternate between three coordinate axes in both directions. In addition, an extra particle is generated on the position of the oxygen with the first letter of the name replaced by 'M'. This is for use with four-atom water models such as TIP4P [104].

11 *four water "hydrogens"*

Same as above, except that two additional particles are generated on the position of the oxygen, with names 'LP1' and 'LP2.' This is for use with five-atom water models such as TIP5P [124].

- The name of the new H atom (or its prefix, e.g. HD2 for the asparagine example given earlier).
- Three or four control atoms (i,j,k,l), where the first always is the atom to which the H atoms are connected. The other two or three depend on the code selected. For water, there is only one control atom.

Some more exotic cases can be approximately constructed from the above tools, and with suitable use of energy minimization are good enough for beginning MD simulations. For example secondary amine hydrogen, nitrenyl hydrogen (C=NH) and even ethynyl hydrogen could be approximately constructed using method 2 above for hydroxyl hydrogen.

5.6.5 Termini database

The termini databases are stored in `aminoacids.n.tdb` and `aminoacids.c.tdb` for the N- and C-termini respectively. They contain information for the `pdb2gmx` program on how to connect new atoms to existing ones, which atoms should be removed or changed, and which bonded interactions should be added. The format of the is as follows (from `gmx.ff/aminoacids.c.tdb`):

```
[ COO- ]
[ replace ]
C      C      C      12.011  0.27
[ add ]
```



```

2      8      O      C      CA      N
      OM      15.9994 -0.635

[ delete ]
O

[ impropers ]
C      O1      O2      CA

[ None ]

```

The file is organized in blocks, each with a header specifying the name of the block. These blocks correspond to different types of termini that can be added to a molecule. In this example [COO⁻] is the first block, corresponding to changing the terminal carbon atom into a deprotonated carboxyl group. [None] is the second terminus type, corresponding to a terminus that leaves the molecule as it is. Block names cannot be any of the following: `replace`, `add`, `delete`, `bonds`, `angles`, `dihedrals`, `impropers`. Doing so would interfere with the parameters of the block, and would probably also be very confusing to human readers.

For each block the following options are present:

- [`replace`]
 Replace an existing atom by one with a different atom type, atom name, charge, and/or mass. This entry can be used to replace an atom that is present both in the input coordinates and in the `.rtp` database, but also to only rename an atom in the input coordinates such that it matches the name in the force field. In the latter case, there should also be a corresponding [`add`] section present that gives instructions to add the same atom, such that the position in the sequence and the bonding is known. Such an atom can be present in the input coordinates and kept, or not present and constructed by `pdb2gmx`. For each atom to be replaced on line should be entered with the following fields:
 - name of the atom to be replaced
 - new atom name (optional)
 - new atom type
 - new mass
 - new charge
- [`add`]
 Add new atoms. For each (group of) added atom(s), a two-line entry is necessary. The first line contains the same fields as an entry in the hydrogen database (name of the new atom, number of atoms, type of addition, control atoms, see 5.6.4), but the possible types of addition are extended by two more, specifically for C-terminal additions:

8 *two carboxyl oxygens, -COO⁻*

Two oxygens (n1,n2) are generated according to rule 3, at a distance of 0.136 nm from atom i and an angle (n1-i-j)=(n2-i-j)=117 degrees

9 *carboxyl oxygens and hydrogen, -COOH*

Two oxygens (n1,n2) are generated according to rule 3, at distances of 0.123 nm and 0.125 nm from atom i for n1 and n2, respectively, and angles (n1-i-j)=121 and (n2-i-j)=115 degrees. One hydrogen (n') is generated around n2 according to rule 2, where n-i-j and n-i-j-k should be read as n'-n2-i and n'-n2-i-j, respectively.

After this line, another line follows that specifies the details of the added atom(s), in the same way as for replacing atoms, *i.e.*:

- atom type
- mass
- charge
- charge group (optional)

Like in the hydrogen database (see 5.6.1), when more than one atom is connected to an existing one, a number will be appended to the end of the atom name. **Note** that, like in the hydrogen database, the atom name is now on the same line as the control atoms, whereas it was at the beginning of the second line prior to GROMACS version 3.3. When the charge group field is left out, the added atom will have the same charge group number as the atom that it is bonded to.

- [delete]
Delete existing atoms. One atom name per line.
- [bonds], [angles], [dihedrals] and [impropers]
Add additional bonded parameters. The format is identical to that used in the *.rtp file, see 5.6.1.

5.6.6 Virtual site database

Since we cannot rely on the positions of hydrogens in input files, we need a special input file to decide the geometries and parameters with which to add virtual site hydrogens. For more complex virtual site constructs (*e.g.* when entire aromatic side chains are made rigid) we also need information about the equilibrium bond lengths and angles for all atoms in the side chain. This information is specified in the .vsd file for each force field. Just as for the termini, there is one such file for each class of residues in the .rtp file.

The virtual site database is not really a very simple list of information. The first couple of sections specify which mass centers (typically called MCH₃/MNH₃) to use for CH₃, NH₃, and NH₂ groups. Depending on the equilibrium bond lengths and angles between the hydrogens and heavy atoms we need to apply slightly different constraint distances between these mass centers. **Note** that we do *not* have to specify the actual parameters (that is automatic), just the type of mass center to use. To accomplish this, there are three sections names [CH₃], [NH₃], and [NH₂]. For each of these we expect three columns. The first column is the atom type bound to the 2/3 hydrogens, the second column is the next heavy atom type which this is bound, and the third column the type of mass center to use. As a special case, in the [NH₂] section it is also possible to specify `planar` in the second column, which will use a different construction without mass center. There

are currently different opinions in some force fields whether an NH₂ group should be planar or not, but we try hard to stick to the default equilibrium parameters of the force field.

The second part of the virtual site database contains explicit equilibrium bond lengths and angles for pairs/triplets of atoms in aromatic side chains. These entries are currently read by specific routines in the virtual site generation code, so if you would like to extend it *e.g.* to nucleic acids you would also need to write new code there. These sections are named after the short amino acid names ([PHE], [TYR], [TRP], [HID], [HIE], [HIP]), and simply contain 2 or 3 columns with atom names, followed by a number specifying the bond length (in nm) or angle (in degrees). **Note** that these are approximations of the equilibrated geometry for the entire molecule, which might not be identical to the equilibrium value for a single bond/angle if the molecule is strained.

5.6.7 Special bonds

The primary mechanism used by *pdb2gmx* to generate inter-residue bonds relies on head-to-tail linking of backbone atoms in different residues to build a macromolecule. In some cases (*e.g.* disulfide bonds, a heme group, branched polymers), it is necessary to create inter-residue bonds that do not lie on the backbone. The file *specbond.dat* takes care of this function. It is necessary that the residues belong to the same [*moleculetype*]. The *-merge* and *-chainsep* functions of *pdb2gmx* can be useful when managing special inter-residue bonds between different chains.

The first line of *specbond.dat* indicates the number of entries that are in the file. If you add a new entry, be sure to increment this number. The remaining lines in the file provide the specifications for creating bonds. The format of the lines is as follows:

```
resA atomA nbondsA resB atomB nbondsB length newresA newresB
```

The columns indicate:

1. *resA* The name of residue A that participates in the bond.
2. *atomA* The name of the atom in residue A that forms the bond.
3. *nbondsA* The total number of bonds *atomA* can form.
4. *resB* The name of residue B that participates in the bond.
5. *atomB* The name of the atom in residue B that forms the bond.
6. *nbondsB* The total number of bonds *atomB* can form.
7. *length* The reference length for the bond. If *atomA* and *atomB* are not within *length* ± 10% in the coordinate file supplied to *pdb2gmx*, no bond will be formed.
8. *newresA* The new name of residue A, if necessary. Some force fields use *e.g.* CYS2 for a cysteine in a disulfide or heme linkage.
9. *newresB* The new name of residue B, likewise.

5.7 File formats

5.7.1 Topology file

The topology file is built following the GROMACS specification for a molecular topology. A `*.top` file can be generated by `pdb2gmx`. All possible entries in the topology file are listed in Tables 5.4 and 5.5. Also tabulated are: all the units of the parameters, which interactions can be perturbed for free energy calculations, which bonded interactions are used by `grompp` for generating exclusions, and which bonded interactions can be converted to constraints by `grompp`.

Parameters

interaction type	directive	# at.	f. tp	parameters	F. E.
<i>mandatory</i>	defaults			non-bonded function type; combination rule ^(cr) ; generate pairs (no/yes); fudge LJ (); fudge QQ ()	
<i>mandatory</i>	atomtypes			atom type; m (u); q (e); particle type; $V^{(cr)}$; $W^{(cr)}$	
	bondtypes			(see Table 5.5, directive bonds)	
	pairtypes			(see Table 5.5, directive pairs)	
	angletypes			(see Table 5.5, directive angles)	
	dihedraltypes ^(*)			(see Table 5.5, directive dihedrals)	
	constrainttypes			(see Table 5.5, directive constraints)	
LJ	nonbond_params	2	1	$V^{(cr)}$; $W^{(cr)}$	
Buckingham	nonbond_params	2	2	a (kJ mol ⁻¹); b (nm ⁻¹); c_6 (kJ mol ⁻¹ nm ⁶)	

Molecule definition(s)

<i>mandatory</i>	moleculetype			molecule name; $n_{ex}^{(nrexcl)}$	
<i>mandatory</i>	atoms	1		atom type; residue number; residue name; atom name; charge group number; q (e); m (u)	type q, m
intra-molecular interaction and geometry definitions as described in Table 5.5					

System

<i>mandatory</i>	system			system name	
<i>mandatory</i>	molecules			molecule name; number of molecules	

'# at' is the required number of atom type indices for this directive

'f. tp' is the value used to select this function type

'F. E.' indicates which of the parameters for this interaction can be interpolated during free energy calculations

^(cr) the combination rule determines the type of LJ parameters, see 5.3.2

^(*) for dihedraltypes one can specify 4 atoms or the inner (outer for improper) 2 atoms

^(nrexcl) exclude neighbors n_{ex} bonds away for non-bonded interactions

For free energy calculations, type, q and m or no parameters should be added for topology 'B' ($\lambda = 1$) on the same line, after the normal parameters.

Table 5.4: The topology (* .top) file.

Table 5.5: Details of [moleculetype] directives

Name of interaction	Topology file directive	num. atoms*	func. type [†]	Order of parameters and their units	use in F.E.? [‡]	Cross-references
bond	bonds ^{§,¶}	2	1	b_0 (nm); k_b (kJ mol ⁻¹ nm ⁻²)	all	4.2.1
G96 bond	bonds ^{§,¶}	2	2	b_0 (nm); k_b (kJ mol ⁻¹ nm ⁻⁴)	all	4.2.1
Morse	bonds ^{§,¶}	2	3	b_0 (nm); D (kJ mol ⁻¹); β (nm ⁻¹)	all	4.2.2
cubic bond	bonds ^{§,¶}	2	4	b_0 (nm); $C_{i=2,3}$ (kJ mol ⁻¹ nm ⁻ⁱ)		4.2.3
connection	bonds [§]	2	5			5.4
harmonic potential	bonds	2	6	b_0 (nm); k_b (kJ mol ⁻¹ nm ⁻²)	all	4.2.1,5.4
FENE bond	bonds [§]	2	7	b_m (nm); k_b (kJ mol ⁻¹ nm ⁻²)		4.2.4
tabulated bond	bonds [§]	2	8	table number (≥ 0); k (kJ mol ⁻¹)	k	4.2.13
tabulated bond	bonds	2	9	table number (≥ 0); k (kJ mol ⁻¹)	k	4.2.13,5.4
restraint potential	bonds	2	10	low, up ₁ , up ₂ (nm); k_{dr} (kJ mol ⁻¹ nm ⁻²)	all	4.3.4
extra LJ or Coulomb	pairs	2	1	V^{**} ; W^{**}	all	5.3.4
extra LJ or Coulomb	pairs	2	2	fudge QQ (); q_i, q_j (e), V^{**} ; W^{**}		5.3.4
extra LJ or Coulomb	pairs_nb	2	1	q_i, q_j (e); V^{**} ; W^{**}		5.3.4
angle	angles [¶]	3	1	θ_0 (deg); k_θ (kJ mol ⁻¹ rad ⁻²)	all	4.2.5
G96 angle	angles [¶]	3	2	θ_0 (deg); k_θ (kJ mol ⁻¹)	all	4.2.6
cross bond-bond	angles	3	3	r_{1e}, r_{2e} (nm); $k_{rr'}$ (kJ mol ⁻¹ nm ⁻²)		4.2.8
cross bond-angle	angles	3	4	r_{1e}, r_{2e}, r_{3e} (nm); $k_{r\theta}$ (kJ mol ⁻¹ nm ⁻²)		4.2.9
Urey-Bradley	angles [¶]	3	5	θ_0 (deg); k_θ (kJ mol ⁻¹ rad ⁻²); r_{13} (nm); k_{UB} (kJ mol ⁻¹ nm ⁻²)	all	4.2.7
quartic angle	angles [¶]	3	6	θ_0 (deg); $C_{i=0,1,2,3,4}$ (kJ mol ⁻¹ rad ⁻ⁱ)		4.2.10

*The required number of atom indices for this directive

[†]The index to use to select this function type

[‡]Indicates which of the parameters for this interaction can be interpolated during free energy calculations

[§]This interaction type will be used by `grompp` for generating exclusions

[¶]This interaction type can be converted to constraints by `grompp`

**The combination rule determines the type of LJ parameters, see 5.3.2

^{||}No connection, and so no exclusions, are generated for this interaction

Table 5.5: Details of [moleculetype] directives

Name of interaction	Topology file directive	num. atoms*	func. type [†]	Order of parameters and their units	use in F.E.? [‡]	Cross-references
tabulated angle	angles	3	8	table number (≥ 0); k (kJ mol ⁻¹)	k	4.2.13
proper dihedral	dihedrals	4	1	ϕ_s (deg); k_ϕ (kJ mol ⁻¹); multiplicity	ϕ, k	4.2.12
improper dihedral	dihedrals	4	2	ξ_0 (deg); k_ξ (kJ mol ⁻¹ rad ⁻²)	all	4.2.11
Ryckaert-Bellemans dihedral	dihedrals	4	3	$C_0, C_1, C_2, C_3, C_4, C_5$ (kJ mol ⁻¹)	all	4.2.12
periodic improper dihedral	dihedrals	4	4	ϕ_s (deg); k_ϕ (kJ mol ⁻¹); multiplicity	ϕ, k	4.2.11
Fourier dihedral	dihedrals	4	5	C_1, C_2, C_3, C_4 (kJ mol ⁻¹)	all	4.2.12
tabulated dihedral	dihedrals	4	8	table number (≥ 0); k (kJ mol ⁻¹)	k	4.2.13
proper dihedral (multiple)	dihedrals	4	9	ϕ_s (deg); k_ϕ (kJ mol ⁻¹); multiplicity	ϕ, k	4.2.12
exclusions	exclusions	1		one or more atom indices		5.4
constraint	constraints [§]	2	1	b_0 (nm)	all	4.5,5.5
constraint	constraints	2	2	b_0 (nm)	all	4.5,5.5,5.4
SETTLE	settles	1	1	d_{OH}, d_{HH} (nm)		3.6.1,5.5
2-body virtual site	virtual_sites2	3	1	a ()		4.7
3-body virtual site	virtual_sites3	4	1	a, b ()		4.7
3-body virtual site (fd)	virtual_sites3	4	2	a (); d (nm)		4.7
3-body virtual site (fad)	virtual_sites3	4	3	θ (deg); d (nm)		4.7
3-body virtual site (out)	virtual_sites3	4	4	a, b (); c (nm ⁻¹)		4.7
4-body virtual site (fdn)	virtual_sites4	5	2	a, b (); c (nm)		4.7
N-body virtual site (COG)	virtual_sitesn	1	1	one or more constructing atom indices		4.7
N-body virtual site (COM)	virtual_sitesn	1	2	one or more constructing atom indices		4.7
N-body virtual site (COW)	virtual_sitesn	1	3	one or more pairs consisting of constructing atom index and weight		4.7
position restraint	position_restraints	1	1	k_x, k_y, k_z (kJ mol ⁻¹ nm ⁻²)	all	4.3.1
distance restraint	distance_restraints	2	1	type; label; low, up ₁ , up ₂ (nm); weight ()		4.3.4
dihedral restraint	dihedral_restraints	4	1	ϕ_0 (deg); $\Delta\phi$ (deg);	all	4.3.3
orientation restraint	orientation_restraints	2	1	exp.; label; α ; c (U nm ^{α}); obs. (U); weight (U ⁻¹)		4.3.5

Table 5.5: Details of [moleculetype] directives

Name of interaction	Topology file directive	num. atoms*	func. type [†]	Order of parameters and their units	use in F.E.? [‡]	Cross-references
angle restraint	angle_restraints	4	1	θ_0 (deg); k_c (kJ mol ⁻¹); multiplicity	θ, k	4.3.2
angle restraint (z)	angle_restraints_z	2	1	θ_0 (deg); k_c (kJ mol ⁻¹); multiplicity	θ, k	4.3.2

Description of the file layout:

- Semicolon (;) and newline characters surround comments
- On a line ending with \ the newline character is ignored.
- Directives are surrounded by [and]
- The topology hierarchy (which must be followed) consists of three levels:
 - the parameter level, which defines certain force field specifications (see Table 5.4)
 - the molecule level, which should contain one or more molecule definitions (see Table 5.5)
 - the system level, containing only system-specific information ([system] and [molecules])
- Items should be separated by spaces or tabs, not commas
- Atoms in molecules should be numbered consecutively starting at 1
- Atoms in the same charge group must be listed consecutively
- The file is parsed only once, which implies that no forward references can be treated: items must be defined before they can be used
- Exclusions can be generated from the bonds or overridden manually
- The bonded force types can be generated from the atom types or overridden per bond
- It is possible to apply multiple bonded interactions of the same type on the same atoms
- Descriptive comment lines and empty lines are highly recommended
- Starting with GROMACS version 3.1.3, all directives at the parameter level can be used multiple times and there are no restrictions on the order, except that an atom type needs to be defined before it can be used in other parameter definitions
- If parameters for a certain interaction are defined multiple times for the same combination of atom types the last definition is used; starting with GROMACS version 3.1.3 grompp generates a warning for parameter redefinitions with different values
- Using one of the [atoms], [bonds], [pairs], [angles], etc. without having used [moleculetype] before is meaningless and generates a warning
- Using [molecules] without having used [system] before is meaningless and generates a warning.
- After [system] the only allowed directive is [molecules]
- Using an unknown string in [] causes all the data until the next directive to be ignored and generates a warning

Here is an example of a topology file, urea.top:

```

;
;       Example topology file
;
; The force field files to be included
#include "gmx.ff/forcefield.itp"

[ moleculetype ]
; name nrexcl
Urea      3

[ atoms ]
;  nr   type  resnr  residu   atom   cgnr  charge
   1     C     1     UREA    C1     1     0.683
   2     O     1     UREA    O2     1    -0.683
   3     NT    1     UREA    N3     2    -0.622
   4     H     1     UREA    H4     2     0.346
   5     H     1     UREA    H5     2     0.276
   6     NT    1     UREA    N6     3    -0.622
   7     H     1     UREA    H7     3     0.346
   8     H     1     UREA    H8     3     0.276

[ bonds ]
;  ai   aj  funct          b0          kb
   3    4    1 1.000000e-01 3.744680e+05
   3    5    1 1.000000e-01 3.744680e+05
   6    7    1 1.000000e-01 3.744680e+05
   6    8    1 1.000000e-01 3.744680e+05
   1    2    1 1.230000e-01 5.020800e+05
   1    3    1 1.330000e-01 3.765600e+05
   1    6    1 1.330000e-01 3.765600e+05

[ pairs ]
;  ai   aj  funct          c6          c12
   2    4    1 0.000000e+00 0.000000e+00
   2    5    1 0.000000e+00 0.000000e+00
   2    7    1 0.000000e+00 0.000000e+00
   2    8    1 0.000000e+00 0.000000e+00
   3    7    1 0.000000e+00 0.000000e+00
   3    8    1 0.000000e+00 0.000000e+00
   4    6    1 0.000000e+00 0.000000e+00
   5    6    1 0.000000e+00 0.000000e+00

[ angles ]
;  ai   aj   ak  funct          th0          cth
   1    3    4    1 1.200000e+02 2.928800e+02
   1    3    5    1 1.200000e+02 2.928800e+02
   4    3    5    1 1.200000e+02 3.347200e+02
   1    6    7    1 1.200000e+02 2.928800e+02
   1    6    8    1 1.200000e+02 2.928800e+02
   7    6    8    1 1.200000e+02 3.347200e+02

```

```

2      1      3      1 1.215000e+02 5.020800e+02
2      1      6      1 1.215000e+02 5.020800e+02
3      1      6      1 1.170000e+02 5.020800e+02

[ dihedrals ]
; ai    aj    ak    al funct          phi          cp          mult
  2     1     3     4     1 1.800000e+02 3.347200e+01 2.000000e+00
  6     1     3     4     1 1.800000e+02 3.347200e+01 2.000000e+00
  2     1     3     5     1 1.800000e+02 3.347200e+01 2.000000e+00
  6     1     3     5     1 1.800000e+02 3.347200e+01 2.000000e+00
  2     1     6     7     1 1.800000e+02 3.347200e+01 2.000000e+00
  3     1     6     7     1 1.800000e+02 3.347200e+01 2.000000e+00
  2     1     6     8     1 1.800000e+02 3.347200e+01 2.000000e+00
  3     1     6     8     1 1.800000e+02 3.347200e+01 2.000000e+00

[ dihedrals ]
; ai    aj    ak    al funct          q0          cq
  3     4     5     1     2 0.000000e+00 1.673600e+02
  6     7     8     1     2 0.000000e+00 1.673600e+02
  1     3     6     2     2 0.000000e+00 1.673600e+02

[ position_restraints ]
; you wouldn't normally use this for a molecule like Urea,
; but we include it here for didactic purposes
; ai    funct    fc
  1     1        1000    1000    1000 ; Restrain to a point
  2     1        1000     0    1000 ; Restrain to a line (Y-axis)
  3     1        1000     0     0 ; Restrain to a plane (Y-Z-plane)

; Include SPC water topology
#include "spc.itp"

[ system ]
Urea in Water

[ molecules ]
;molecule name    nr.
Urea                1
SOL                 1000

```

Here follows the explanatory text.

```
[ defaults ] :
```

- `nbfunc` is the non-bonded function type. Use 1 (Lennard-Jones) or 2 (Buckingham)
- `comb-rule` is the number of the combination rule (see 5.3.2).
- `gen-pairs` is for pair generation. The default is 'no', *i.e.* get 1-4 parameters from the `pairtypes` list. When parameters are not present in the list, stop with a fatal error. Setting 'yes' generates 1-4 parameters that are not present in the pair list from normal Lennard-Jones parameters using `fudgeLJ`

- `fudgeLJ` is the factor by which to multiply Lennard-Jones 1-4 interactions, default 1
- `fudgeQQ` is the factor by which to multiply electrostatic 1-4 interactions, default 1
- N is the power for the repulsion term in a 6- N potential (with nonbonded-type Lennard-Jones only), starting with GROMACS version 4.5, `mdrun` also reads and applies N , for values not equal to 12 tabulated interaction functions are used (in older version you would have to use user tabulated interactions).

Note that `gen-pairs`, `fudgeLJ`, `fudgeQQ`, and N are optional. `fudgeLJ` is only used when `generate pairs` is set to 'yes', and `fudgeQQ` is always used. However, if you want to specify N you need to give a value for the other parameters as well.

`#include "gmx.ff/forcefield.itp"` : this includes the bonded and non-bonded force field parameters, the `gmx` in `gmx.ff` will be replaced by the name of the force field you are actually using.

[`moleculetype`] : defines the name of your molecule in this `*.top` and `nrexcl = 3` stands for excluding non-bonded interactions between atoms that are no further than 3 bonds away.

[`atoms`] : defines the molecule, where `nr` and `type` are fixed, the rest is user defined. So `atom` can be named as you like, `cgnr` made larger or smaller (if possible, the total charge of a charge group should be zero), and charges can be changed here too.

[`bonds`] : no comment.

[`pairs`] : LJ and Coulomb 1-4 interactions

[`angles`] : no comment

[`dihedrals`] : in this case there are 9 proper dihedrals (`funct = 1`), 3 improper (`funct = 2`) and no Ryckaert-Bellemans type dihedrals. If you want to include Ryckaert-Bellemans type dihedrals in a topology, do the following (in case of *e.g.* decane):

```
[ dihedrals ]
; ai    aj    ak    al  funct    c0    c1    c2
  1     2     3     4    3
  2     3     4     5    3
```

In the original implementation of the potential for alkanes [125] no 1-4 interactions were used, which means that in order to implement that particular force field you need to remove the 1-4 interactions from the [`pairs`] section of your topology. In most modern force fields, like OPLS/AA or Amber the rules are different, and the Ryckaert-Bellemans potential is used as a cosine series in combination with 1-4 interactions.

[`position_restraints`] : harmonically restrain the selected particles to reference positions (4.3.1). The reference positions are read from a separate coordinate file by `grompp`.

`#include "spc.itp"` : includes a topology file that was already constructed (see section 5.7.2).

[`system`] : title of your system, user-defined

[`molecules`] : this defines the total number of (sub)molecules in your system that are defined in this `*.top`. In this example file, it stands for 1 urea molecule dissolved in 1000 water

molecules. The molecule type SOL is defined in the `spc.itp` file. Each name here must correspond to a name given with `[moleculetype]` earlier in the topology. The order of the blocks of molecule types and the numbers of such molecules must match the coordinate file that accompanies the topology when supplied to `grompp`. The blocks of molecules do not need to be contiguous, but some tools (e.g. `genion`) may act only on the first or last such block of a particular molecule type. Also, these blocks have nothing to do with the definition of groups (see sec. 3.3 and sec. 8.1).

5.7.2 Molecule.itp file

If you construct a topology file you will use frequently (like the water molecule, `spc.itp`, which is already constructed for you) it is good to make a `molecule.itp` file. This only lists the information of one particular molecule and allows you to re-use the `[moleculetype]` in multiple systems without re-invoking `pdb2gmx` or manually copying and pasting. An example follows:

```
[ moleculetype ]
; name nrexcl
Urea      3

[ atoms ]
; nr   type  resnr  residu   atom   cgnr  charge
   1    C     1     UREA    C1     1     0.683
   .....
   8    H     1     UREA    H8     3     0.276

[ bonds ]
; ai   aj  funct          c0          c1
   3    4    1 1.000000e-01 3.744680e+05
   .....
   1    6    1 1.330000e-01 3.765600e+05

[ pairs ]
; ai   aj  funct          c0          c1
   2    4    1 0.000000e+00 0.000000e+00
   .....
   5    6    1 0.000000e+00 0.000000e+00

[ angles ]
; ai   aj   ak  funct          c0          c1
   1    3    4    1 1.200000e+02 2.928800e+02
   .....
   3    1    6    1 1.170000e+02 5.020800e+02

[ dihedrals ]
```

```

; ai    aj    ak    al funct          c0          c1          c2
  2     1     3     4     1 1.800000e+02 3.347200e+01 2.000000e+00
  .....
  .....
  3     1     6     8     1 1.800000e+02 3.347200e+01 2.000000e+00

[ dihedrals ]
; ai    aj    ak    al funct          c0          c1
  3     4     5     1     2 0.000000e+00 1.673600e+02
  6     7     8     1     2 0.000000e+00 1.673600e+02
  1     3     6     2     2 0.000000e+00 1.673600e+02

```

Using *.itp files results in a very short *.top file:

```

; The force field files to be included
#include "gmx.ff/forcefield.itp"

; Include urea topology
#include "urea.itp"

; Include SPC water topology
#include "spc.itp"

[ system ]
Urea in Water

[ molecules ]
;molecule name  number
Urea              1
SOL               1000

```

5.7.3 Ifdef statements

A very powerful feature in GROMACS is the use of `#ifdef` statements in your *.top file. By making use of this statement, different parameters for one molecule can be used in the same *.top file. An example is given for TFE, where there is an option to use different charges on the atoms: charges derived by De Loof *et al.* [126] or by Van Buuren and Berendsen [105]. In fact, you can use much of the functionality of the C preprocessor, `cpp`, because `grompp` contains similar pre-processing functions to scan the file. The way to make use of the `#ifdef` option is as follows:

- either use the option `define = -DDeLoof` in the *.mdp file (containing `grompp` input parameters), or use the line `#define DeLoof` early in your *.top or *.itp file; and
- put the `#ifdef` statements in your *.top, as shown below:

...

```

[ atoms ]
; nr      type      resnr      residu      atom      cgnr      charge      mass
#ifdef DeLoof
; Use Charges from DeLoof
  1      C      1      TFE      C      1      0.74
  2      F      1      TFE      F      1      -0.25
  3      F      1      TFE      F      1      -0.25
  4      F      1      TFE      F      1      -0.25
  5      CH2     1      TFE      CH2     1      0.25
  6      OA      1      TFE      OA      1      -0.65
  7      HO      1      TFE      HO      1      0.41
#else
; Use Charges from VanBuuren
  1      C      1      TFE      C      1      0.59
  2      F      1      TFE      F      1      -0.2
  3      F      1      TFE      F      1      -0.2
  4      F      1      TFE      F      1      -0.2
  5      CH2     1      TFE      CH2     1      0.26
  6      OA      1      TFE      OA      1      -0.55
  7      HO      1      TFE      HO      1      0.3
#endif

[ bonds ]
; ai      aj      funct      c0      c1
  6      7      1 1.000000e-01 3.138000e+05
  1      2      1 1.360000e-01 4.184000e+05
  1      3      1 1.360000e-01 4.184000e+05
  1      4      1 1.360000e-01 4.184000e+05
  1      5      1 1.530000e-01 3.347000e+05
  5      6      1 1.430000e-01 3.347000e+05
  ...

```

This mechanism is used by `pdb2gmx` to implement optional position restraints (4.3.1) by `#including` an `.itp` file whose contents will be meaningful only if a particular `#define` is set (and spelled correctly!)

5.7.4 Topologies for free energy calculations

Free energy differences between two systems, A and B, can be calculated as described in sec. 3.12. Systems A and B are described by topologies consisting of the same number of molecules with the same number of atoms. Masses and non-bonded interactions can be perturbed by adding B parameters under the `[atoms]` directive. Bonded interactions can be perturbed by adding B parameters to the bonded types or the bonded interactions. The parameters that can be perturbed are listed in Tables 5.4 and 5.5. The λ -dependence of the interactions is described in section sec. 4.5. The bonded parameters that are used (on the line of the bonded interaction definition, or the ones looked up on atom types in the bonded type lists) is explained in Table 5.6. In most cases, things should work intuitively. When the A and B atom types in a bonded interaction are not all identical and parameters are not present for the B-state, either on the line or in the bonded types,

B-state atom types all identical to A-state atom types	parameters on line		parameters in bonded types				message
	A	B	A atom types		B atom types		
	A	B	A	B	A	B	
yes	+AB	-	x	x			error
	+A	+B	x	x			
	-	-	-	-			
	-	-	+AB	-			
	-	-	+A	+B			
no	+AB	-	x	x	x	x	warning
	+A	+B	x	x	x	x	error
	-	-	-	-	x	x	
	-	-	+AB	-	-	-	warning
	-	-	+A	+B	-	-	warning
	-	-	+A	x	+B	-	
	-	-	+A	x	+	+B	

Table 5.6: The bonded parameters that are used for free energy topologies, on the line of the bonded interaction definition or looked up in the bond types section based on atom types. A and B indicate the parameters used for state A and B respectively, + and - indicate the (non-)presence of parameters in the topology, x indicates that the presence has no influence.

`grompp` uses the A-state parameters and issues a warning. For free energy calculations, all or no parameters for topology B ($\lambda = 1$) should be added on the same line, after the normal parameters, in the same order as the normal parameters. From GROMACS 4.6 onward, if λ is treated as a vector, then the `bonded-lambdas` component controls all bonded terms that are not explicitly labeled as restraints. Restrain terms are controlled by the `restraint-lambdas` component.

Below is an example of a topology which changes from 200 propanols to 200 pentanes using the GROMOS-96 force field.

```
; Include force field parameters
#include "gromos43a1.ff/forcefield.itp"

[ moleculetype ]
; Name          nrexcl
PropPent        3

[ atoms ]
; nr type  resnr  residue  atom  cgnr  charge    mass  typeB  chargeB  massB
  1  H     1     PROP    PH    1     0.398    1.008  CH3    0.0     15.035
  2  OA     1     PROP    PO    1    -0.548   15.9994 CH2    0.0     14.027
  3  CH2    1     PROP    PC1   1     0.150    14.027  CH2    0.0     14.027
  4  CH2    1     PROP    PC2   2     0.000    14.027
  5  CH3    1     PROP    PC3   2     0.000    15.035

[ bonds ]
```



```

; ai    aj funct    par_A par_B
  1     2     2     gb_1  gb_26
  2     3     2     gb_17 gb_26
  3     4     2     gb_26 gb_26
  4     5     2     gb_26

[ pairs ]
; ai    aj funct
  1     4     1
  2     5     1

[ angles ]
; ai    aj    ak funct    par_A par_B
  1     2     3     2     ga_11 ga_14
  2     3     4     2     ga_14 ga_14
  3     4     5     2     ga_14 ga_14

[ dihedrals ]
; ai    aj    ak    al funct    par_A par_B
  1     2     3     4     1     gd_12 gd_17
  2     3     4     5     1     gd_17 gd_17

[ system ]
; Name
Propanol to Pentane

[ molecules ]
; Compound    #mols
PropPent      200

```

Atoms that are not perturbed, PC2 and PC3, do not need B-state parameter specifications, since the B parameters will be copied from the A parameters. Bonded interactions between atoms that are not perturbed do not need B parameter specifications, as is the case for the last bond in the example topology. Topologies using the OPLS/AA force field need no bonded parameters at all, since both the A and B parameters are determined by the atom types. Non-bonded interactions involving one or two perturbed atoms use the free-energy perturbation functional forms. Non-bonded interactions between two non-perturbed atoms use the normal functional forms. This means that when, for instance, only the charge of a particle is perturbed, its Lennard-Jones interactions will also be affected when lambda is not equal to zero or one.

Note that this topology uses the GROMOS-96 force field, in which the bonded interactions are not determined by the atom types. The bonded interaction strings are converted by the C-preprocessor. The force field parameter files contain lines like:

```

#define gb_26          0.1530  7.1500e+06

#define gd_17          0.000    5.86          3

```

5.7.5 Constraint forces

The constraint force between two atoms in one molecule can be calculated with the free energy perturbation code by adding a constraint between the two atoms, with a different length in the A and B topology. When the B length is 1 nm longer than the A length and lambda is kept constant at zero, the derivative of the Hamiltonian with respect to lambda is the constraint force. For constraints between molecules, the pull code can be used, see sec. 6.4. Below is an example for calculating the constraint force at 0.7 nm between two methanes in water, by combining the two methanes into one “molecule.” **Note** that the definition of a “molecule” in GROMACS does not necessarily correspond to the chemical definition of a molecule. In GROMACS, a “molecule” can be defined as any group of atoms that one wishes to consider simultaneously. The added constraint is of function type 2, which means that it is not used for generating exclusions (see sec. 5.4). Note that the constraint free energy term is included in the derivative term, and is specifically included in the bonded-lambdas component. However, the free energy for changing constraints is *not* included in the potential energy differences used for BAR and MBAR, as this requires reevaluating the energy at each of the constraint components. This functionality is planned for later versions.

```
; Include force field parameters
#include "gromos43a1.ff/forcefield.itp"

[ moleculetype ]
; Name          nrexcl
Methanes       1

[ atoms ]
; nr   type   resnr  residu   atom   cgnr   charge   mass
  1   CH4     1     CH4     C1     1     0     16.043
  2   CH4     1     CH4     C2     2     0     16.043

[ constraints ]
; ai   aj  funct   length_A  length_B
  1    2    2       0.7         1.7

#include "spc.itp"

[ system ]
; Name
Methanes in Water

[ molecules ]
; Compound      #mols
Methanes        1
SOL              2002
```

5.7.6 Coordinate file

Files with the `.gro` file extension contain a molecular structure in GROMOS-87 format. A sample piece is included below:

```

MD of 2 waters, reformat step, PA aug-91
 6
 1WATER OW1 1 0.126 1.624 1.679 0.1227 -0.0580 0.0434
 1WATER HW2 2 0.190 1.661 1.747 0.8085 0.3191 -0.7791
 1WATER HW3 3 0.177 1.568 1.613 -0.9045 -2.6469 1.3180
 2WATER OW1 4 1.275 0.053 0.622 0.2519 0.3140 -0.1734
 2WATER HW2 5 1.337 0.002 0.680 -1.0641 -1.1349 0.0257
 2WATER HW3 6 1.326 0.120 0.568 1.9427 -0.8216 -0.0244
1.82060 1.82060 1.82060

```

This format is fixed, *i.e.* all columns are in a fixed position. If you want to read such a file in your own program without using the GROMACS libraries you can use the following formats:

C-format: "%5i%5s%5s%5i%8.3f%8.3f%8.3f%8.4f%8.4f%8.4f"

Or to be more precise, with title *etc.* it looks like this:

```

"%s\n", Title
"%5d\n", natoms
for (i=0; (i<natoms); i++) {
    "%5d%5s%5s%5d%8.3f%8.3f%8.3f%8.4f%8.4f%8.4f\n",
        residuenr, residuename, atomname, atomnr, x, y, z, vx, vy, vz
}
"%10.5f%10.5f%10.5f%10.5f%10.5f%10.5f%10.5f%10.5f%10.5f\n",
    box[X][X], box[Y][Y], box[Z][Z],
    box[X][Y], box[X][Z], box[Y][X], box[Y][Z], box[Z][X], box[Z][Y]

```

Fortran format: (i5,2a5,i5,3f8.3,3f8.4)

So `conf.in.gro` is the GROMACS coordinate file and is almost the same as the GROMOS-87 file (for GROMOS users: when used with `ntx=7`). The only difference is the box for which GROMACS uses a tensor, not a vector.

5.8 Force field organization

5.8.1 Force field files

As of GROMACS version 4.5, 14 force fields are available by default. Force fields are detected by the presence of `<name>.ff` directories in the GROMACS `/share/top` sub-directory and/or the working directory. The information regarding the location of the force field files is printed by `pdb2gmx` so you can easily keep track of which version of a force field is being called, in case you have made modifications in one location or another. The force fields included with GROMACS are:

- AMBER03 force field (Duan et al., J. Comp. Chem. 24, 1999-2012, 2003)
- AMBER94 force field (Cornell et al., JACS 117, 5179-5197, 1995)
- AMBER96 force field (Kollman et al., Acc. Chem. Res. 29, 461-469, 1996)

- AMBER99 force field (Wang et al., J. Comp. Chem. 21, 1049-1074, 2000)
- AMBER99SB force field (Hornak et al., Proteins 65, 712-725, 2006)
- AMBER99SB-ILDN force field (Lindorff-Larsen et al., Proteins 78, 1950-58, 2010)
- AMBERGS force field (Garcia & Sanbonmatsu, PNAS 99, 2782-2787, 2002)
- CHARMM27 all-atom force field (with CMAP)
- GROMOS96 43A1 force field
- GROMOS96 43A2 force field (improved alkane dihedrals)
- GROMOS96 45A3 force field (Schuler JCC 2001 22 1205)
- GROMOS96 53A5 force field (JCC 2004 vol 25 pag 1656)
- GROMOS96 53A6 force field (JCC 2004 vol 25 pag 1656)
- OPLS-AA/L all-atom force field (2001 aminoacid dihedrals)

There are also some additional deprecated force fields listed in the selection from `pdb2gmx`, but we do not currently recommend that you use those for new simulations.

A force field is included at the beginning of a topology file with an `#include` statement followed by `<name>.ff/forcefield.itp`. This statement includes the force field file, which, in turn, may include other force field files. All the force fields are organized in the same way. As an example, we show the `gmx.ff/forcefield.itp` file:

```
#define _FF_GROMACS
#define _FF_GROMACS1

[ defaults ]
; nbfunc      comb-rule      gen-pairs      fudgeLJ  fudgeQQ
  1           1             no             1.0      1.0

#include "ffnonbonded.itp"
#include "ffbonded.itp"
```

The first `#define` can be used in topologies to parse data which is specific for all GROMACS force fields, the second `#define` is to parse data specific to this force field. The `[defaults]` section is explained in 5.7.1. The included file `ffnonbonded.itp` contains all atom types and non-bonded parameters. The included file `ffbonded.itp` contains all bonded parameters.

For each force field, there several files which are only used by `pdb2gmx`. These are: residue databases (`.rtp`, see 5.6.1) the hydrogen database (`.hdb`, see 5.6.4), two termini databases (`.n.tdb` and `.c.tdb`, see 5.6.5) and the atom type database (`.atp`, see 5.2.1), which contains only the masses. Other optional files are described in sec. 5.6.

5.8.2 Changing force field parameters

If one wants to change the parameters of few bonded interactions in a molecule, this is most easily accomplished by typing the parameters behind the definition of the bonded interaction directly in

the `*.top` file under the `[moleculetype]` section (see 5.7.1 for the format and units). If one wants to change the parameters for all instances of a certain interaction one can change them in the force-field file or add a new `[???types]` section after including the force field. When parameters for a certain interaction are defined multiple times, the last definition is used. As of GROMACS version 3.1.3, a warning is generated when parameters are redefined with a different value. Changing the Lennard-Jones parameters of an atom type is not recommended, because in the GROMOS force fields the Lennard-Jones parameters for several combinations of atom types are not generated according to the standard combination rules. Such combinations (and possibly others that do follow the combination rules) are defined in the `[nonbond_params]` section, and changing the Lennard-Jones parameters of an atom type has no effect on these combinations.

5.8.3 Adding atom types

As of GROMACS version 3.1.3, atom types can be added in an extra `[atomtypes]` section after the the inclusion of the normal force field. After the definition of the new atom type(s), additional non-bonded and pair parameters can be defined. In pre-3.1.3 versions of GROMACS, the new atom types needed to be added in the `[atomtypes]` section of the force field files, because all non-bonded parameters above the last `[atomtypes]` section would be overwritten using the standard combination rules.

5.9 `gmx.ff` documentation

For backward compatibility we retain here some reference to parameters present in the `gmx.ff` force field. The last 10 atom types were not part of the original GROMOS-87 force field [78], so if you use them you should refer to one or more of the following papers:

- F was taken from ref. [105],
- CP2 and CP3 from ref. [102] and references cited therein,
- CR5, CR6 and HCR from ref. [127]
- OWT3 from ref. [104]
- SD, OD and CD from ref. [106]

Note that we recommend against using these parameters in new projects since they are not well-tested.

Chapter 6

Special Topics

6.1 Free energy implementation

For free energy calculations, there are two things that must be specified; the end states, and the pathway connecting the end states. The end states can be specified in two ways. The most straightforward is through the specification of end states in the topology file. Most potential forms support both an *A* state and a *B* state. Whenever both states are specified, then the *A* state corresponds to the initial free energy state, and the *B* state corresponds to the final state.

In some cases, the end state can also be defined in some cases without altering the topology, solely through the `.mdp` file, through the use of the `couple-moltype`, `couple-lambda0`, `couple-lambda1`, and `couple-intramol` `mdp` keywords. Any molecule type selected in `couple-moltype` will automatically have a *B* state implicitly constructed (and the *A* state redefined) according to the `couple-lambda` keywords. `couple-lambda0` and `couple-lambda1` define the non-bonded parameters that are present in the *A* state (`couple-lambda0`) and the *B* state (`couple-lambda1`). The choices are 'q', 'vdw', and 'vdw-q'; these indicate the Coulombic, van der Waals, or both parameters that are turned on in the respective state.

Once the end states are defined, then the path between the end states has to be defined. This path is defined solely in the `.mdp` file. Starting in 4.6, λ is a vector of components, with Coulombic, van der Waals, bonded, restraint, and mass components all able to be adjusted independently. This makes it possible to turn off the Coulombic term linearly, and then the van der Waals using soft core, all in the same simulation. This is especially useful for replica exchange or expanded ensemble simulations, where it is important to sample all the way from interacting to non-interacting states in the same simulation to improve sampling.

`fep-lambdas` is the default array of λ values ranging from 0 to 1. All of the other `lambda` arrays use the values in this array if they are not specified. The previous behavior, where the pathway is controlled by a single λ variable, can be preserved by using only `fep-lambdas` to define the pathway.

For example, if you wanted to first to change the Coulombic terms, then the van der Waals terms, changing bonded at the same time rate as the van der Waals, but changing the restraints through-

out the first two-thirds of the simulation, then you could use this λ vector:

```
coul-lambdas      = 0.0 0.2 0.5 1.0 1.0 1.0 1.0 1.0 1.0 1.0
vdw-lambdas       = 0.0 0.0 0.0 0.0 0.4 0.5 0.6 0.7 0.8 1.0
bonded-lambdas    = 0.0 0.0 0.0 0.0 0.4 0.5 0.6 0.7 0.8 1.0
restraint-lambdas = 0.0 0.0 0.1 0.2 0.3 0.5 0.7 1.0 1.0 1.0
```

This is also equivalent to:

```
fep-lambdas      = 0.0 0.0 0.0 0.0 0.4 0.5 0.6 0.7 0.8 1.0
coul-lambdas     = 0.0 0.2 0.5 1.0 1.0 1.0 1.0 1.0 1.0 1.0
restraint-lambdas = 0.0 0.0 0.1 0.2 0.3 0.5 0.7 1.0 1.0 1.0
```

The `fep-lambda` array, in this case, is being used as the default to fill in the bonded and van der Waals λ arrays. Usually, it's best to fill in all arrays explicitly, just to make sure things are properly assigned.

If you want to turn on only restraints going from A to B , then it would be:

```
restraint-lambdas = 0.0 0.1 0.2 0.4 0.6 1.0
```

and all of the other components of the λ vector would be left in the A state.

To compute free energies with a vector λ using thermodynamic integration, then the TI equation becomes vector equation:

$$\Delta F = \int \langle \nabla H \rangle \cdot d\vec{\lambda} \quad (6.1)$$

or for finite differences:

$$\Delta F \approx \int \sum \langle \nabla H \rangle \cdot \Delta\lambda \quad (6.2)$$

The external `pymbar` script downloaded from <https://SimTK.org/home/pymbar> can compute this integral automatically from the GROMACS `dhdl.xvg` output.

6.2 Potential of mean force

A potential of mean force (PMF) is a potential that is obtained by integrating the mean force from an ensemble of configurations. In GROMACS, there are several different methods to calculate the mean force. Each method has its limitations, which are listed below.

- **pull code:** between the centers of mass of molecules or groups of molecules.
- **free-energy code with harmonic bonds or constraints:** between single atoms.
- **free-energy code with position restraints:** changing the conformation of a relatively immobile group of atoms.

- **pull code in limited cases:** between groups of atoms that are part of a larger molecule for which the bonds are constrained with SHAKE or LINCS. If the pull group is relatively large, the pull code can be used.

The pull and free-energy code are described in more detail in the following two sections.

Entropic effects

When a distance between two atoms or the centers of mass of two groups is constrained or restrained, there will be a purely entropic contribution to the PMF due to the rotation of the two groups [128]. For a system of two non-interacting masses the potential of mean force is:

$$V_{pmf}(r) = -(n_c - 1)k_B T \log(r) \quad (6.3)$$

where n_c is the number of dimensions in which the constraint works (i.e. $n_c = 3$ for a normal constraint and $n_c = 1$ when only the z -direction is constrained). Whether one needs to correct for this contribution depends on what the PMF should represent. When one wants to pull a substrate into a protein, this entropic term indeed contributes to the work to get the substrate into the protein. But when calculating a PMF between two solutes in a solvent, for the purpose of simulating without solvent, the entropic contribution should be removed. **Note** that this term can be significant; when at 300K the distance is halved, the contribution is 3.5 kJ mol⁻¹.

6.3 Non-equilibrium pulling

When the distance between two groups is changed continuously, work is applied to the system, which means that the system is no longer in equilibrium. Although in the limit of very slow pulling the system is again in equilibrium, for many systems this limit is not reachable within reasonable computational time. However, one can use the Jarzynski relation [129] to obtain the equilibrium free-energy difference ΔG between two distances from many non-equilibrium simulations:

$$\Delta G_{AB} = -k_B T \log \left\langle e^{-\beta W_{AB}} \right\rangle_A \quad (6.4)$$

where W_{AB} is the work performed to force the system along one path from state A to B, the angular bracket denotes averaging over a canonical ensemble of the initial state A and $\beta = 1/k_B T$.

6.4 The pull code

The pull code applies forces or constraints between the centers of mass of one or more pairs of groups of atoms. There is one reference group and one or more other pull groups. Instead of a reference group, one can also use absolute reference point in space. The most common situation consists of a reference group and one pull group. In this case, the two groups are treated equivalently. The distance between a pair of groups can be determined in 1, 2 or 3 dimensions, or can be along a user-defined vector. The reference distance can be constant or can change linearly with time. Normally all atoms are weighted by their mass, but an additional weighting factor can also be used.

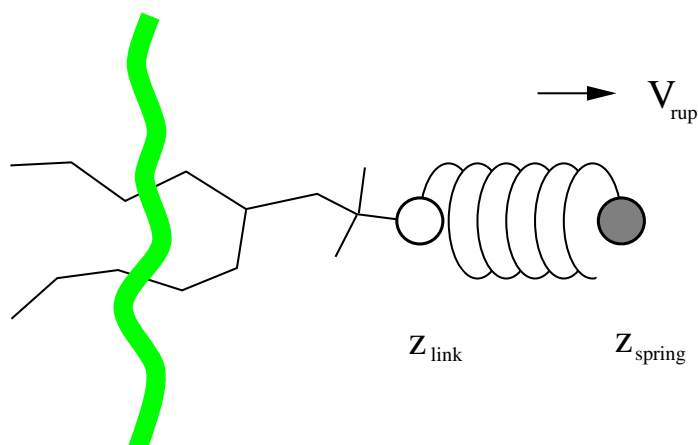

Figure 6.1: Schematic picture of pulling a lipid out of a lipid bilayer with umbrella pulling. V_{rup} is the velocity at which the spring is retracted, Z_{link} is the atom to which the spring is attached and Z_{spring} is the location of the spring.

Three different types of calculation are supported, and in all cases the reference distance can be constant or linearly changing with time.

1. **Umbrella pulling** A harmonic potential is applied between the centers of mass of two groups. Thus, the force is proportional to the displacement.
2. **Constraint pulling** The distance between the centers of mass of two groups is constrained. The constraint force can be written to a file. This method uses the SHAKE algorithm but only needs 1 iteration to be exact if only two groups are constrained.
3. **Constant force pulling** A constant force is applied between the centers of mass of two groups. Thus, the potential is linear. In this case there is no reference distance or pull rate.

Definition of the center of mass

In GROMACS, there are three ways to define the center of mass of a group. The standard way is a “plain” center of mass, possibly with additional weighting factors. With periodic boundary conditions it is no longer possible to uniquely define the center of mass of a group of atoms. Therefore, a reference atom is used. For determining the center of mass, for all other atoms in the group, the closest periodic image to the reference atom is used. This uniquely defines the center of mass. By default, the middle (determined by the order in the topology) atom is used as a reference atom, but the user can also select any other atom if it would be closer to center of the group.

For a layered system, for instance a lipid bilayer, it may be of interest to calculate the PMF of a lipid as function of its distance from the whole bilayer. The whole bilayer can be taken as reference group in that case, but it might also be of interest to define the reaction coordinate for the PMF more locally. The `.mdp` option `pull_geometry = cylinder` does not use all the atoms of the reference group, but instead dynamically only those within a cylinder with radius `r_1` around the pull vector going through the pull group. This only works for distances defined in

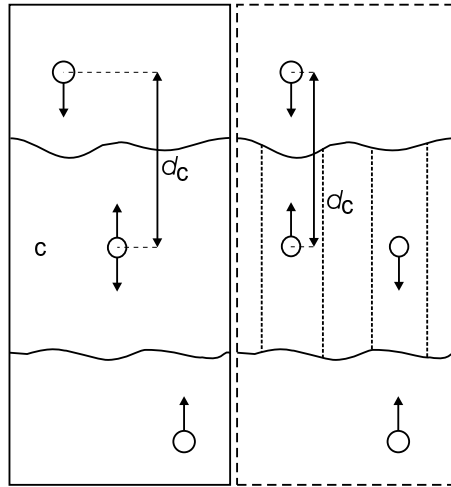

Figure 6.2: Comparison of a plain center of mass reference group versus a cylinder reference group applied to interface systems. C is the reference group. The circles represent the center of mass of two groups plus the reference group, d_c is the reference distance.

one dimension, and the cylinder is oriented with its long axis along this one dimension. A second cylinder can be defined with r_0 , with a linear switch function that weighs the contribution of atoms between r_0 and r_1 with distance. This smooths the effects of atoms moving in and out of the cylinder (which causes jumps in the pull forces).

For a group of molecules in a periodic system, a plain reference group might not be well-defined. An example is a water slab that is connected periodically in x and y , but has two liquid-vapor interfaces along z . In such a setup, water molecules can evaporate from the liquid and they will move through the vapor, through the periodic boundary, to the other interface. Such a system is inherently periodic and there is no proper way of defining a “plain” center of mass along z . A proper solution is to use a cosine shaped weighting profile for all atoms in the reference group. The profile is a cosine with a single period in the unit cell. Its phase is optimized to give the maximum sum of weights, including mass weighting. This provides a unique and continuous reference position that is nearly identical to the plain center of mass position in case all atoms are all within a half of the unit-cell length. See ref [130] for details.

When relative weights w_i are used during the calculations, either by supplying weights in the input or due to cylinder geometry or due to cosine weighting, the weights need to be scaled to conserve momentum:

$$w'_i = w_i \sum_{j=1}^N w_j m_j / \sum_{j=1}^N w_j^2 m_j \quad (6.5)$$

where m_j is the mass of atom j of the group. The mass of the group, required for calculating the constraint force, is:

$$M = \sum_{i=1}^N w'_i m_i \quad (6.6)$$

The definition of the weighted center of mass is:

$$\mathbf{r}_{com} = \sum_{i=1}^N w'_i m_i \mathbf{r}_i / M \quad (6.7)$$

From the centers of mass the AFM, constraint, or umbrella force \mathbf{F}_{com} on each group can be calculated. The force on the center of mass of a group is redistributed to the atoms as follows:

$$\mathbf{F}_i = \frac{w'_i m_i}{M} \mathbf{F}_{com} \quad (6.8)$$

Limitations

There is one important limitation: strictly speaking, constraint forces can only be calculated between groups that are not connected by constraints to the rest of the system. If a group contains part of a molecule of which the bond lengths are constrained, the pull constraint and LINCS or SHAKE bond constraint algorithms should be iterated simultaneously. This is not done in GRO-MACS. This means that for simulations with `constraints = all-bonds` in the `.mdp` file pulling is, strictly speaking, limited to whole molecules or groups of molecules. In some cases this limitation can be avoided by using the free energy code, see sec. 6.6. In practice, the errors caused by not iterating the two constraint algorithms can be negligible when the pull group consists of a large amount of atoms and/or the pull force is small. In such cases, the constraint correction displacement of the pull group is small compared to the bond lengths.

6.5 Enforced Rotation

This module can be used to enforce the rotation of a group of atoms, as *e.g.* a protein subunit. There are a variety of rotation potentials, among them complex ones that allow flexible adaptations of both the rotated subunit as well as the local rotation axis during the simulation. An example application can be found in ref. [131].

6.5.1 Fixed Axis Rotation

Stationary Axis with an Isotropic Potential

In the fixed axis approach (see Fig. 6.3B), torque on a group of N atoms with positions \mathbf{x}_i (denoted “rotation group”) is applied by rotating a reference set of atomic positions – usually their initial positions \mathbf{y}_i^0 – at a constant angular velocity ω around an axis defined by a direction vector $\hat{\mathbf{v}}$ and a pivot point \mathbf{u} . To that aim, each atom with position \mathbf{x}_i is attracted by a “virtual spring” potential to its moving reference position $\mathbf{y}_i = \mathbf{\Omega}(t)(\mathbf{y}_i^0 - \mathbf{u})$, where $\mathbf{\Omega}(t)$ is a matrix that describes the rotation around the axis. In the simplest case, the “springs” are described by a harmonic potential,

$$V^{\text{iso}} = \frac{k}{2} \sum_{i=1}^N w_i \left[\mathbf{\Omega}(t)(\mathbf{y}_i^0 - \mathbf{u}) - (\mathbf{x}_i - \mathbf{u}) \right]^2, \quad (6.9)$$

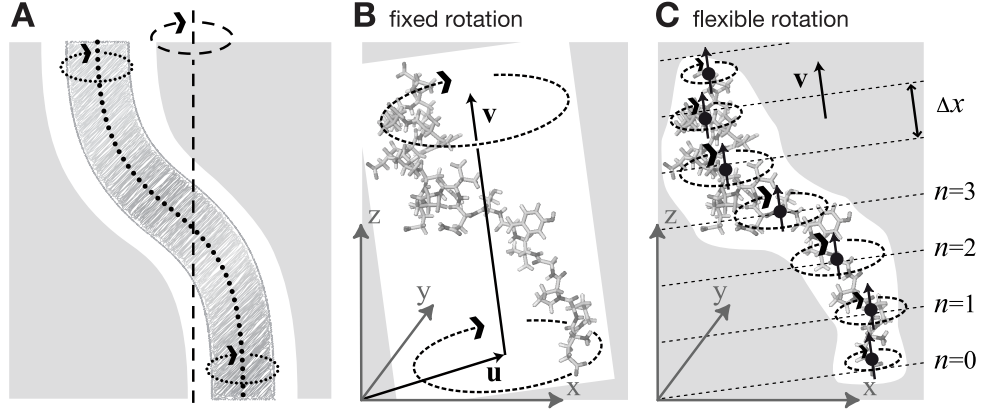

Figure 6.3: Comparison of fixed and flexible axis rotation. **A**: Rotating the sketched shape inside the white tubular cavity can create artifacts when a fixed rotation axis (dashed) is used. More realistically, the shape would revolve like a flexible pipe-cleaner (dotted) inside the bearing (gray). **B**: Fixed rotation around an axis \mathbf{v} with a pivot point specified by the vector \mathbf{u} . **C**: Subdividing the rotating fragment into slabs with separate rotation axes (\uparrow) and pivot points (\bullet) for each slab allows for flexibility. The distance between two slabs with indices n and $n + 1$ is Δx .

with optional mass-weighted prefactors $w_i = N m_i/M$ with total mass $M = \sum_{i=1}^N m_i$. The rotation matrix $\mathbf{\Omega}(t)$ is

$$\mathbf{\Omega}(t) = \begin{pmatrix} \cos \omega t + v_x^2 \xi & v_x v_y \xi - v_z \sin \omega t & v_x v_z \xi + v_y \sin \omega t \\ v_x v_y \xi + v_z \sin \omega t & \cos \omega t + v_y^2 \xi & v_y v_z \xi - v_x \sin \omega t \\ v_x v_z \xi - v_y \sin \omega t & v_y v_z \xi + v_x \sin \omega t & \cos \omega t + v_z^2 \xi \end{pmatrix},$$

where v_x, v_y , and v_z are the components of the normalized rotation vector $\hat{\mathbf{v}}$, and $\xi := 1 - \cos(\omega t)$. As illustrated in Fig. 6.4A for a single atom j , the rotation matrix $\mathbf{\Omega}(t)$ operates on the initial reference positions $\mathbf{y}_j^0 = \mathbf{x}_j(t_0)$ of atom j at $t = t_0$. At a later time t , the reference position has rotated away from its initial place (along the blue dashed line), resulting in the force

$$\mathbf{F}_j^{\text{iso}} = -\nabla_j V^{\text{iso}} = k w_j \left[\mathbf{\Omega}(t)(\mathbf{y}_j^0 - \mathbf{u}) - (\mathbf{x}_j - \mathbf{u}) \right], \quad (6.10)$$

which is directed towards the reference position.

Pivot-Free Isotropic Potential

Instead of a fixed pivot vector \mathbf{u} this potential uses the center of mass \mathbf{x}_c of the rotation group as pivot for the rotation axis,

$$\mathbf{x}_c = \frac{1}{M} \sum_{i=1}^N m_i \mathbf{x}_i \quad \text{and} \quad \mathbf{y}_c^0 = \frac{1}{M} \sum_{i=1}^N m_i \mathbf{y}_i^0, \quad (6.11)$$

which yields the “pivot-free” isotropic potential

$$V^{\text{iso-pf}} = \frac{k}{2} \sum_{i=1}^N w_i \left[\mathbf{\Omega}(t)(\mathbf{y}_i^0 - \mathbf{y}_c^0) - (\mathbf{x}_i - \mathbf{x}_c) \right]^2, \quad (6.12)$$

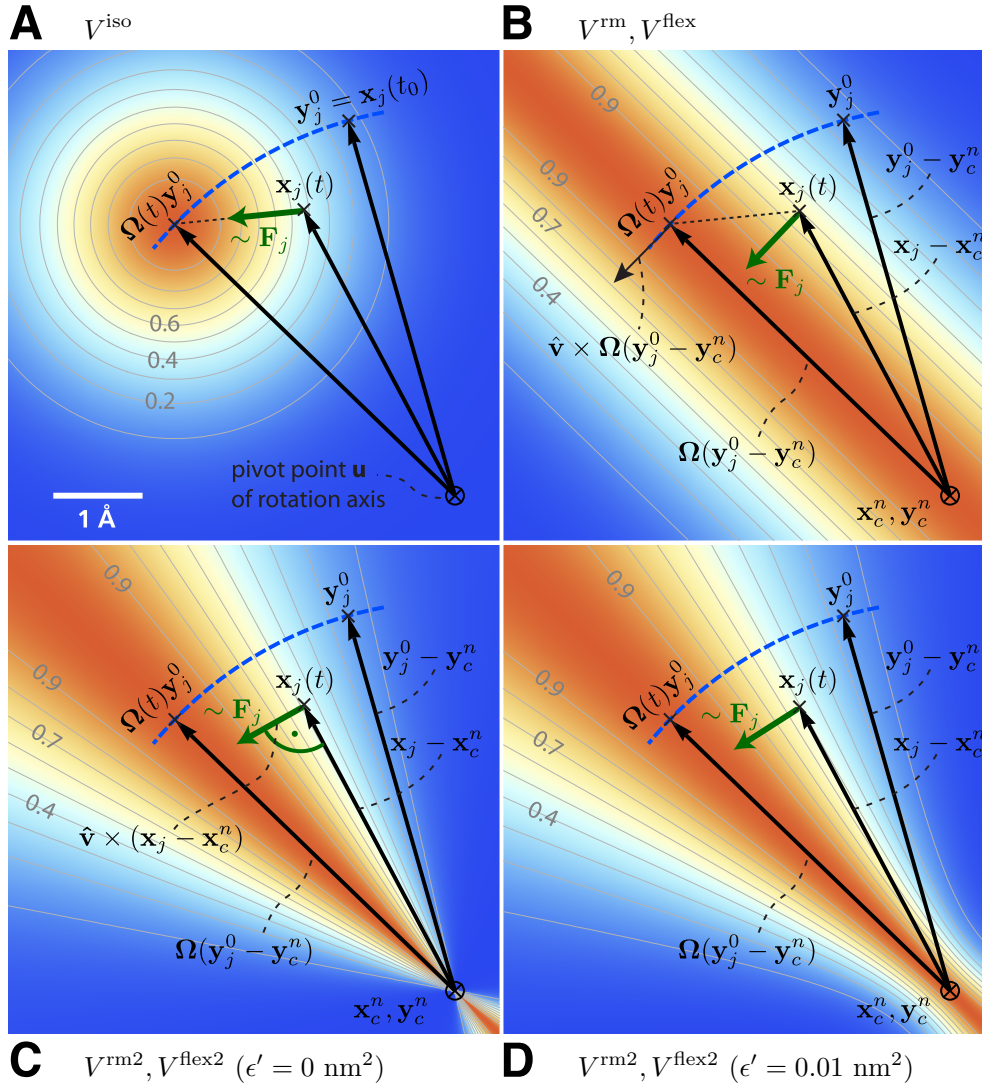

Figure 6.4: Selection of different rotation potentials and definition of notation. All four potentials V (color coded) are shown for a single atom at position $\mathbf{x}_j(t)$. **A**: Isotropic potential V^{iso} , **B**: radial motion potential V^{rm} and flexible potential V^{flex} , **C–D**: radial motion 2 potential $V^{\text{rm}2}$ and flexible 2 potential $V^{\text{flex}2}$ for $\epsilon' = 0 \text{ nm}^2$ (**C**) and $\epsilon' = 0.01 \text{ nm}^2$ (**D**). The rotation axis is perpendicular to the plane and marked by \otimes . The light gray contours indicate Boltzmann factors $e^{-V/(k_B T)}$ in the \mathbf{x}_j -plane for $T = 300 \text{ K}$ and $k = 200 \text{ kJ}/(\text{mol}\cdot\text{nm}^2)$. The green arrow shows the direction of the force \mathbf{F}_j acting on atom j ; the blue dashed line indicates the motion of the reference position.

with forces

$$\mathbf{F}_j^{\text{iso-pf}} = k w_j \left[\boldsymbol{\Omega}(t)(\mathbf{y}_j^0 - \mathbf{y}_c^0) - (\mathbf{x}_j - \mathbf{x}_c) \right]. \quad (6.13)$$

Without mass-weighting, the pivot \mathbf{x}_c is the geometrical center of the group.

Parallel Motion Potential Variant

The forces generated by the isotropic potentials (eqns. 6.9 and 6.12) also contain components parallel to the rotation axis and thereby restrain motions along the axis of either the whole rotation group (in case of V^{iso}) or within the rotation group (in case of $V^{\text{iso-pf}}$). For cases where unrestrained motion along the axis is preferred, we have implemented a “parallel motion” variant by eliminating all components parallel to the rotation axis for the potential. This is achieved by projecting the distance vectors between reference and actual positions

$$\mathbf{r}_i = \boldsymbol{\Omega}(t)(\mathbf{y}_i^0 - \mathbf{u}) - (\mathbf{x}_i - \mathbf{u}) \quad (6.14)$$

onto the plane perpendicular to the rotation vector,

$$\mathbf{r}_i^\perp := \mathbf{r}_i - (\mathbf{r}_i \cdot \hat{\mathbf{v}})\hat{\mathbf{v}}, \quad (6.15)$$

yielding

$$\begin{aligned} V^{\text{pm}} &= \frac{k}{2} \sum_{i=1}^N w_i (\mathbf{r}_i^\perp)^2 \\ &= \frac{k}{2} \sum_{i=1}^N w_i \left\{ \boldsymbol{\Omega}(t)(\mathbf{y}_i^0 - \mathbf{u}) - (\mathbf{x}_i - \mathbf{u}) \right. \\ &\quad \left. - \left\{ \left[\boldsymbol{\Omega}(t)(\mathbf{y}_i^0 - \mathbf{u}) - (\mathbf{x}_i - \mathbf{u}) \right] \cdot \hat{\mathbf{v}} \right\} \hat{\mathbf{v}} \right\}^2, \end{aligned} \quad (6.16)$$

and similarly

$$\mathbf{F}_j^{\text{pm}} = k w_j \mathbf{r}_j^\perp. \quad (6.17)$$

Pivot-Free Parallel Motion Potential

Replacing in eqn. 6.16 the fixed pivot \mathbf{u} by the center of mass \mathbf{x}_c yields the pivot-free variant of the parallel motion potential. With

$$\mathbf{s}_i = \boldsymbol{\Omega}(t)(\mathbf{y}_i^0 - \mathbf{y}_c^0) - (\mathbf{x}_i - \mathbf{x}_c) \quad (6.18)$$

the respective potential and forces are

$$V^{\text{pm-pf}} = \frac{k}{2} \sum_{i=1}^N w_i (\mathbf{s}_i^\perp)^2, \quad (6.19)$$

$$\mathbf{F}_j^{\text{pm-pf}} = k w_j \mathbf{s}_j^\perp. \quad (6.20)$$

Radial Motion Potential

In the above variants, the minimum of the rotation potential is either a single point at the reference position \mathbf{y}_i (for the isotropic potentials) or a single line through \mathbf{y}_i parallel to the rotation axis (for the parallel motion potentials). As a result, radial forces restrict radial motions of the atoms. The two subsequent types of rotation potentials, V^{rm} and $V^{\text{rm}2}$, drastically reduce or even eliminate this effect. The first variant, V^{rm} (Fig. 6.4B), eliminates all force components parallel to the vector connecting the reference atom and the rotation axis,

$$V^{\text{rm}} = \frac{k}{2} \sum_{i=1}^N w_i [\mathbf{p}_i \cdot (\mathbf{x}_i - \mathbf{u})]^2, \quad (6.21)$$

with

$$\mathbf{p}_i := \frac{\hat{\mathbf{v}} \times \boldsymbol{\Omega}(t)(\mathbf{y}_i^0 - \mathbf{u})}{\|\hat{\mathbf{v}} \times \boldsymbol{\Omega}(t)(\mathbf{y}_i^0 - \mathbf{u})\|}. \quad (6.22)$$

This variant depends only on the distance $\mathbf{p}_i \cdot (\mathbf{x}_i - \mathbf{u})$ of atom i from the plane spanned by $\hat{\mathbf{v}}$ and $\boldsymbol{\Omega}(t)(\mathbf{y}_i^0 - \mathbf{u})$. The resulting force is

$$\mathbf{F}_j^{\text{rm}} = -k w_j [\mathbf{p}_j \cdot (\mathbf{x}_j - \mathbf{u})] \mathbf{p}_j. \quad (6.23)$$

Pivot-Free Radial Motion Potential

Proceeding similar to the pivot-free isotropic potential yields a pivot-free version of the above potential. With

$$\mathbf{q}_i := \frac{\hat{\mathbf{v}} \times \boldsymbol{\Omega}(t)(\mathbf{y}_i^0 - \mathbf{y}_c^0)}{\|\hat{\mathbf{v}} \times \boldsymbol{\Omega}(t)(\mathbf{y}_i^0 - \mathbf{y}_c^0)\|}, \quad (6.24)$$

the potential and force for the pivot-free variant of the radial motion potential read

$$V^{\text{rm-pf}} = \frac{k}{2} \sum_{i=1}^N w_i [\mathbf{q}_i \cdot (\mathbf{x}_i - \mathbf{x}_c)]^2, \quad (6.25)$$

$$\mathbf{F}_j^{\text{rm-pf}} = -k w_j [\mathbf{q}_j \cdot (\mathbf{x}_j - \mathbf{x}_c)] \mathbf{q}_j + k \frac{m_j}{M} \sum_{i=1}^N w_i [\mathbf{q}_i \cdot (\mathbf{x}_i - \mathbf{x}_c)] \mathbf{q}_i. \quad (6.26)$$

Radial Motion 2 Alternative Potential

As seen in Fig. 6.4B, the force resulting from V^{rm} still contains a small, second-order radial component. In most cases, this perturbation is tolerable; if not, the following alternative, $V^{\text{rm}2}$, fully eliminates the radial contribution to the force, as depicted in Fig. 6.4C,

$$V^{\text{rm}2} = \frac{k}{2} \sum_{i=1}^N w_i \frac{[(\hat{\mathbf{v}} \times (\mathbf{x}_i - \mathbf{u})) \cdot \boldsymbol{\Omega}(t)(\mathbf{y}_i^0 - \mathbf{u})]^2}{\|\hat{\mathbf{v}} \times (\mathbf{x}_i - \mathbf{u})\|^2 + \epsilon'}, \quad (6.27)$$

where a small parameter ϵ' has been introduced to avoid singularities. For $\epsilon' = 0 \text{ nm}^2$, the equipotential planes are spanned by $\mathbf{x}_i - \mathbf{u}$ and $\hat{\mathbf{v}}$, yielding a force perpendicular to $\mathbf{x}_i - \mathbf{u}$, thus not contracting or expanding structural parts that moved away from or toward the rotation axis.

Choosing a small positive ϵ' (e.g., $\epsilon' = 0.01 \text{ nm}^2$, Fig. 6.4D) in the denominator of eqn. 6.27 yields a well-defined potential and continuous forces also close to the rotation axis, which is not the case for $\epsilon' = 0 \text{ nm}^2$ (Fig. 6.4C). With

$$\mathbf{r}_i := \boldsymbol{\Omega}(t)(\mathbf{y}_i^0 - \mathbf{u}) \quad (6.28)$$

$$\mathbf{s}_i := \frac{\hat{\mathbf{v}} \times (\mathbf{x}_i - \mathbf{u})}{\|\hat{\mathbf{v}} \times (\mathbf{x}_i - \mathbf{u})\|} \equiv \Psi_i \hat{\mathbf{v}} \times (\mathbf{x}_i - \mathbf{u}) \quad (6.29)$$

$$\Psi_i^* := \frac{1}{\|\hat{\mathbf{v}} \times (\mathbf{x}_i - \mathbf{u})\|^2 + \epsilon'} \quad (6.30)$$

the force on atom j reads

$$\mathbf{F}_j^{\text{rm}2} = -k \left\{ w_j (\mathbf{s}_j \cdot \mathbf{r}_j) \left[\frac{\Psi_j^*}{\Psi_j} \mathbf{r}_j - \frac{\Psi_j^{*2}}{\Psi_j^3} (\mathbf{s}_j \cdot \mathbf{r}_j) \mathbf{s}_j \right] \right\} \times \hat{\mathbf{v}}. \quad (6.31)$$

Pivot-Free Radial Motion 2 Potential

The pivot-free variant of the above potential is

$$V^{\text{rm}2\text{-pf}} = \frac{k}{2} \sum_{i=1}^N w_i \frac{[(\hat{\mathbf{v}} \times (\mathbf{x}_i - \mathbf{x}_c)) \cdot \boldsymbol{\Omega}(t)(\mathbf{y}_i^0 - \mathbf{y}_c)]^2}{\|\hat{\mathbf{v}} \times (\mathbf{x}_i - \mathbf{x}_c)\|^2 + \epsilon'}. \quad (6.32)$$

With

$$\mathbf{r}_i := \boldsymbol{\Omega}(t)(\mathbf{y}_i^0 - \mathbf{y}_c) \quad (6.33)$$

$$\mathbf{s}_i := \frac{\hat{\mathbf{v}} \times (\mathbf{x}_i - \mathbf{x}_c)}{\|\hat{\mathbf{v}} \times (\mathbf{x}_i - \mathbf{x}_c)\|} \equiv \Psi_i \hat{\mathbf{v}} \times (\mathbf{x}_i - \mathbf{x}_c) \quad (6.34)$$

$$\Psi_i^* := \frac{1}{\|\hat{\mathbf{v}} \times (\mathbf{x}_i - \mathbf{x}_c)\|^2 + \epsilon'} \quad (6.35)$$

the force on atom j reads

$$\begin{aligned} \mathbf{F}_j^{\text{rm}2\text{-pf}} = & -k \left\{ w_j (\mathbf{s}_j \cdot \mathbf{r}_j) \left[\frac{\Psi_j^*}{\Psi_j} \mathbf{r}_j - \frac{\Psi_j^{*2}}{\Psi_j^3} (\mathbf{s}_j \cdot \mathbf{r}_j) \mathbf{s}_j \right] \right\} \times \hat{\mathbf{v}} \\ & + k \frac{m_j}{M} \left\{ \sum_{i=1}^N w_i (\mathbf{s}_i \cdot \mathbf{r}_i) \left[\frac{\Psi_i^*}{\Psi_i} \mathbf{r}_i - \frac{\Psi_i^{*2}}{\Psi_i^3} (\mathbf{s}_i \cdot \mathbf{r}_i) \mathbf{s}_i \right] \right\} \times \hat{\mathbf{v}}. \end{aligned} \quad (6.36)$$

6.5.2 Flexible Axis Rotation

As sketched in Fig. 6.3A–B, the rigid body behavior of the fixed axis rotation scheme is a drawback for many applications. In particular, deformations of the rotation group are suppressed when the equilibrium atom positions directly depend on the reference positions. To avoid this limitation, eqns. 6.26 and 6.32 will now be generalized towards a “flexible axis” as sketched in Fig. 6.3C. This will be achieved by subdividing the rotation group into a set of equidistant slabs perpendicular to the rotation vector, and by applying a separate rotation potential to each of these slabs. Fig. 6.3C shows the midplanes of the slabs as dotted straight lines and the centers as thick black dots.

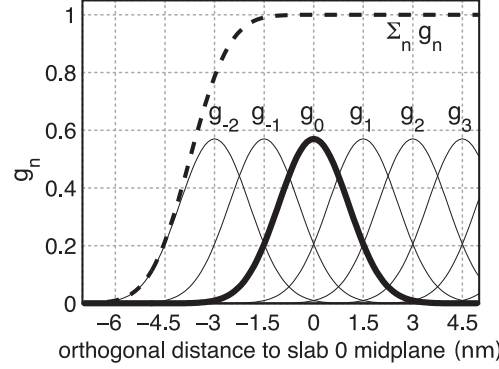

Figure 6.5: Gaussian functions g_n centered at $n \Delta x$ for a slab distance $\Delta x = 1.5$ nm and $n \geq -2$. Gaussian function g_0 is highlighted in bold; the dashed line depicts the sum of the shown Gaussian functions.

To avoid discontinuities in the potential and in the forces, we define “soft slabs” by weighing the contributions of each slab n to the total potential function V^{flex} by a Gaussian function

$$g_n(\mathbf{x}_i) = \Gamma \exp\left(-\frac{\beta_n^2(\mathbf{x}_i)}{2\sigma^2}\right), \quad (6.37)$$

centered at the midplane of the n th slab. Here σ is the width of the Gaussian function, Δx the distance between adjacent slabs, and

$$\beta_n(\mathbf{x}_i) := \mathbf{x}_i \cdot \hat{\mathbf{v}} - n \Delta x. \quad (6.38)$$

A most convenient choice is $\sigma = 0.7\Delta x$ and

$$1/\Gamma = \sum_{n \in \mathbb{Z}} \exp\left(-\frac{(n - \frac{1}{4})^2}{2 \cdot 0.7^2}\right) \approx 1.75464,$$

which yields a nearly constant sum, essentially independent of \mathbf{x}_i (dashed line in Fig. 6.5), *i.e.*,

$$\sum_{n \in \mathbb{Z}} g_n(\mathbf{x}_i) = 1 + \epsilon(\mathbf{x}_i), \quad (6.39)$$

with $|\epsilon(\mathbf{x}_i)| < 1.3 \cdot 10^{-4}$. This choice also implies that the individual contributions to the force from the slabs add up to unity such that no further normalization is required.

To each slab center \mathbf{x}_c^n , all atoms contribute by their Gaussian-weighted (optionally also mass-weighted) position vectors $g_n(\mathbf{x}_i) \mathbf{x}_i$. The instantaneous slab centers \mathbf{x}_c^n are calculated from the current positions \mathbf{x}_i ,

$$\mathbf{x}_c^n = \frac{\sum_{i=1}^N g_n(\mathbf{x}_i) m_i \mathbf{x}_i}{\sum_{i=1}^N g_n(\mathbf{x}_i) m_i}, \quad (6.40)$$

while the reference centers \mathbf{y}_c^n are calculated from the reference positions \mathbf{y}_i^0 ,

$$\mathbf{y}_c^n = \frac{\sum_{i=1}^N g_n(\mathbf{y}_i^0) m_i \mathbf{y}_i^0}{\sum_{i=1}^N g_n(\mathbf{y}_i^0) m_i}. \quad (6.41)$$

Due to the rapid decay of g_n , each slab will essentially involve contributions from atoms located within $\approx 3\Delta x$ from the slab center only.

Flexible Axis Potential

We consider two flexible axis variants. For the first variant, the slab segmentation procedure with Gaussian weighting is applied to the radial motion potential (eqn. 6.26 / Fig. 6.4B), yielding as the contribution of slab n

$$V^n = \frac{k}{2} \sum_{i=1}^N w_i g_n(\mathbf{x}_i) [\mathbf{q}_i^n \cdot (\mathbf{x}_i - \mathbf{x}_c^n)]^2,$$

and a total potential function

$$V^{\text{flex}} = \sum_n V^n. \quad (6.42)$$

Note that the global center of mass \mathbf{x}_c used in eqn. 6.26 is now replaced by \mathbf{x}_c^n , the center of mass of the slab. With

$$\mathbf{q}_i^n := \frac{\hat{\mathbf{v}} \times \boldsymbol{\Omega}(t)(\mathbf{y}_i^0 - \mathbf{y}_c^n)}{\|\hat{\mathbf{v}} \times \boldsymbol{\Omega}(t)(\mathbf{y}_i^0 - \mathbf{y}_c^n)\|} \quad (6.43)$$

$$b_i^n := \mathbf{q}_i^n \cdot (\mathbf{x}_i - \mathbf{x}_c^n), \quad (6.44)$$

the resulting force on atom j reads

$$\begin{aligned} \mathbf{F}_j^{\text{flex}} = & -k w_j \sum_n g_n(\mathbf{x}_j) b_j^n \left\{ \mathbf{q}_j^n - b_j^n \frac{\beta_n(\mathbf{x}_j)}{2\sigma^2} \hat{\mathbf{v}} \right\} \\ & + k m_j \sum_n \frac{g_n(\mathbf{x}_j)}{\sum_h g_n(\mathbf{x}_h)} \sum_{i=1}^N w_i g_n(\mathbf{x}_i) b_i^n \left\{ \mathbf{q}_i^n - \frac{\beta_n(\mathbf{x}_j)}{\sigma^2} [\mathbf{q}_i^n \cdot (\mathbf{x}_j - \mathbf{x}_c^n)] \hat{\mathbf{v}} \right\}. \end{aligned} \quad (6.45)$$

Note that for V^{flex} , as defined, the slabs are fixed in space and so are the reference centers \mathbf{y}_c^n . If during the simulation the rotation group moves too far in \mathbf{v} direction, it may enter a region where – due to the lack of nearby reference positions – no reference slab centers are defined, rendering the potential evaluation impossible. We therefore have included a slightly modified version of this potential that avoids this problem by attaching the midplane of slab $n = 0$ to the center of mass of the rotation group, yielding slabs that move with the rotation group. This is achieved by subtracting the center of mass \mathbf{x}_c of the group from the positions,

$$\tilde{\mathbf{x}}_i = \mathbf{x}_i - \mathbf{x}_c, \quad \text{and} \quad \tilde{\mathbf{y}}_i^0 = \mathbf{y}_i^0 - \mathbf{y}_c^0, \quad (6.46)$$

such that

$$V^{\text{flex-t}} = \frac{k}{2} \sum_n \sum_{i=1}^N w_i g_n(\tilde{\mathbf{x}}_i) \left[\frac{\hat{\mathbf{v}} \times \boldsymbol{\Omega}(t)(\tilde{\mathbf{y}}_i^0 - \tilde{\mathbf{y}}_c^n)}{\|\hat{\mathbf{v}} \times \boldsymbol{\Omega}(t)(\tilde{\mathbf{y}}_i^0 - \tilde{\mathbf{y}}_c^n)\|} \cdot (\tilde{\mathbf{x}}_i - \tilde{\mathbf{x}}_c^n) \right]^2. \quad (6.47)$$

To simplify the force derivation, and for efficiency reasons, we here assume \mathbf{x}_c to be constant, and thus $\partial \mathbf{x}_c / \partial x = \partial \mathbf{x}_c / \partial y = \partial \mathbf{x}_c / \partial z = 0$. The resulting force error is small (of order $O(1/N)$ or $O(m_j/M)$ if mass-weighting is applied) and can therefore be tolerated. With this assumption, the forces $\mathbf{F}^{\text{flex-t}}$ have the same form as eqn. 6.45.

Flexible Axis 2 Alternative Potential

In this second variant, slab segmentation is applied to $V^{\text{rm}2}$ (eqn. 6.32), resulting in a flexible axis potential without radial force contributions (Fig. 6.4C),

$$V^{\text{flex}2} = \frac{k}{2} \sum_{i=1}^N \sum_n w_i g_n(\mathbf{x}_i) \frac{[(\hat{\mathbf{v}} \times (\mathbf{x}_i - \mathbf{x}_c^n)) \cdot \boldsymbol{\Omega}(t)(\mathbf{y}_i^0 - \mathbf{y}_c^n)]^2}{\|\hat{\mathbf{v}} \times (\mathbf{x}_i - \mathbf{x}_c^n)\|^2 + \epsilon'}. \quad (6.48)$$

With

$$\mathbf{r}_i^n := \boldsymbol{\Omega}(t)(\mathbf{y}_i^0 - \mathbf{y}_c^n) \quad (6.49)$$

$$\mathbf{s}_i^n := \frac{\hat{\mathbf{v}} \times (\mathbf{x}_i - \mathbf{x}_c^n)}{\|\hat{\mathbf{v}} \times (\mathbf{x}_i - \mathbf{x}_c^n)\|} \equiv \psi_i \hat{\mathbf{v}} \times (\mathbf{x}_i - \mathbf{x}_c^n) \quad (6.50)$$

$$\psi_i^* := \frac{1}{\|\hat{\mathbf{v}} \times (\mathbf{x}_i - \mathbf{x}_c^n)\|^2 + \epsilon'} \quad (6.51)$$

$$W_j^n := \frac{g_n(\mathbf{x}_j) m_j}{\sum_h g_n(\mathbf{x}_h) m_h} \quad (6.52)$$

$$\mathbf{S}^n := \sum_{i=1}^N w_i g_n(\mathbf{x}_i) (\mathbf{s}_i^n \cdot \mathbf{r}_i^n) \left[\frac{\psi_i^*}{\psi_i} \mathbf{r}_i^n - \frac{\psi_i^{*2}}{\psi_i^3} (\mathbf{s}_i^n \cdot \mathbf{r}_i^n) \mathbf{s}_i^n \right] \quad (6.53)$$

the force on atom j reads

$$\begin{aligned} \mathbf{F}_j^{\text{flex}2} &= -k \left\{ \sum_n w_j g_n(\mathbf{x}_j) (\mathbf{s}_j^n \cdot \mathbf{r}_j^n) \left[\frac{\psi_j^*}{\psi_j} \mathbf{r}_j^n - \frac{\psi_j^{*2}}{\psi_j^3} (\mathbf{s}_j^n \cdot \mathbf{r}_j^n) \mathbf{s}_j^n \right] \right\} \times \hat{\mathbf{v}} \\ &+ k \left\{ \sum_n W_j^n \mathbf{S}^n \right\} \times \hat{\mathbf{v}} - k \left\{ \sum_n W_j^n \frac{\beta_n(\mathbf{x}_j)}{\sigma^2} \frac{1}{\psi_j} \mathbf{s}_j^n \cdot \mathbf{S}^n \right\} \hat{\mathbf{v}} \\ &+ \frac{k}{2} \left\{ \sum_n w_j g_n(\mathbf{x}_j) \frac{\beta_n(\mathbf{x}_j)}{\sigma^2} \frac{\psi_j^*}{\psi_j^2} (\mathbf{s}_j^n \cdot \mathbf{r}_j^n)^2 \right\} \hat{\mathbf{v}}. \end{aligned} \quad (6.54)$$

Applying transformation (6.46) yields a “translation-tolerant” version of the flexible 2 potential, $V^{\text{flex}2\text{-t}}$. Again, assuming that $\partial \mathbf{x}_c / \partial x$, $\partial \mathbf{x}_c / \partial y$, $\partial \mathbf{x}_c / \partial z$ are small, the resulting equations for $V^{\text{flex}2\text{-t}}$ and $\mathbf{F}^{\text{flex}2\text{-t}}$ are similar to those of $V^{\text{flex}2}$ and $\mathbf{F}^{\text{flex}2}$.

6.5.3 Usage

To apply enforced rotation, the particles i that are to be subjected to one of the rotation potentials are defined via index groups `rot_group0`, `rot_group1`, etc., in the `.mdp` input file. The reference positions \mathbf{y}_i^0 are read from a special `.trr` file provided to `grompp`. If no such file is found, $\mathbf{x}_i(t=0)$ are used as reference positions and written to `.trr` such that they can be used for subsequent setups. All parameters of the potentials such as k , ϵ' , etc. (Table 6.1) are provided as `.mdp` parameters; `rot_type` selects the type of the potential. The option `rot_massw` allows to choose whether or not to use mass-weighted averaging. For the flexible potentials, a cutoff value g_n^{min} (typically $g_n^{\text{min}} = 0.001$) makes shure that only significant contributions to V and \mathbf{F} are evaluated, *i.e.* terms with $g_n(\mathbf{x}) < g_n^{\text{min}}$ are omitted. Table 6.2 summarizes observables that are written to additional output files and which are described below.

Table 6.1: Parameters used by the various rotation potentials. x's indicate which parameter is actually used for a given potential.

parameter		k	\hat{v}	\mathbf{u}	ω	ϵ'	Δx	g_n^{\min}
.mdp input variable name		k	vec	pivot	rate	eps	slab_dist	min_gauss
unit		$\frac{\text{kJ}}{\text{mol}\cdot\text{nm}^2}$	-	nm	$^\circ/\text{ps}$	nm^2	nm	-
fixed axis potentials:	eqn.							
isotropic	V^{iso}	(6.9)	X	X	X	-	-	-
— pivot-free	$V^{\text{iso-pf}}$	(6.12)	X	X	-	X	-	-
parallel motion	V^{pm}	(6.16)	X	X	X	-	-	-
— pivot-free	$V^{\text{pm-pf}}$	(6.20)	X	X	-	X	-	-
radial motion	V^{rm}	(6.21)	X	X	X	-	-	-
— pivot-free	$V^{\text{rm-pf}}$	(6.26)	X	X	-	X	-	-
radial motion 2	V^{rm2}	(6.27)	X	X	X	X	-	-
— pivot-free	$V^{\text{rm2-pf}}$	(6.32)	X	X	-	X	-	-
flexible axis potentials:	eqn.							
flexible	V^{flex}	(6.42)	X	X	-	X	-	X
— transl. tol.	$V^{\text{flex-t}}$	(6.47)	X	X	-	X	-	X
flexible 2	V^{flex2}	(6.48)	X	X	-	X	X	X
— transl. tol.	$V^{\text{flex2-t}}$	-	X	X	-	X	X	X

Table 6.2: Quantities recorded in output files during enforced rotation simulations. All slab-wise data is written every `nstout` steps, other rotation data every `nstrout` steps.

quantity	unit	equation	output file	fixed	flexible
$V(t)$	kJ/mol	see 6.1	rotation	X	X
$\theta_{\text{ref}}(t)$	degrees	$\theta_{\text{ref}}(t) = \omega t$	rotation	X	X
$\theta_{\text{av}}(t)$	degrees	(6.55)	rotation	X	-
$\theta_{\text{fit}}(t), \theta_{\text{fit}}(t, n)$	degrees	(6.57)	rotangles	-	X
$\mathbf{y}_0(n), \mathbf{x}_0(t, n)$	nm	(6.40, 6.41)	rotslabs	-	X
$\tau(t)$	kJ/mol	(6.58)	rotation	X	-
$\tau(t, n)$	kJ/mol	(6.58)	rottorque	-	X

Angle of Rotation Groups: Fixed Axis

For fixed axis rotation, the average angle $\theta_{\text{av}}(t)$ of the group relative to the reference group is determined via the distance-weighted angular deviation of all rotation group atoms from their reference positions,

$$\theta_{\text{av}} = \frac{\sum_{i=1}^N r_i \theta_i}{\sum_{i=1}^N r_i}. \quad (6.55)$$

Here, r_i is the distance of the reference position to the rotation axis, and the difference angles θ_i are determined from the atomic positions, projected onto a plane perpendicular to the rotation axis through pivot point \mathbf{u} (see eqn. 6.15 for the definition of \perp),

$$\cos \theta_i = \frac{(\mathbf{y}_i - \mathbf{u})^\perp \cdot (\mathbf{x}_i - \mathbf{u})^\perp}{\|(\mathbf{y}_i - \mathbf{u})^\perp \cdot (\mathbf{x}_i - \mathbf{u})^\perp\|}. \quad (6.56)$$

The sign of θ_{av} is chosen such that $\theta_{\text{av}} > 0$ if the actual structure rotates ahead of the reference.

Angle of Rotation Groups: Flexible Axis

For flexible axis rotation, two outputs are provided, the angle of the entire rotation group, and separate angles for the segments in the slabs. The angle of the entire rotation group is determined by an RMSD fit of \mathbf{x}_i to the reference positions \mathbf{y}_i^0 at $t = 0$, yielding θ_{fit} as the angle by which the reference has to be rotated around $\hat{\mathbf{v}}$ for the optimal fit,

$$\text{RMSD}(\mathbf{x}_i, \mathbf{\Omega}(\theta_{\text{fit}})\mathbf{y}_i^0) \stackrel{!}{=} \min. \quad (6.57)$$

To determine the local angle for each slab n , both reference and actual positions are weighted with the Gaussian function of slab n , and $\theta_{\text{fit}}(t, n)$ is calculated as in eqn. 6.57) from the Gaussian-weighted positions.

For all angles, the `.mdp` input option `rot_fit_method` controls whether a normal RMSD fit is performed or whether for the fit each position \mathbf{x}_i is put at the same distance to the rotation axis as its reference counterpart \mathbf{y}_i^0 . In the latter case, the RMSD measures only angular differences, not radial ones.

Angle Determination by Searching the Energy Minimum

Alternatively, for `rot_fit_method = potential`, the angle of the rotation group is determined as the angle for which the rotation potential energy is minimal. Therefore, the used rotation potential is additionally evaluated for a set of angles around the current reference angle. In this case, the `rotangles.log` output file contains the values of the rotation potential at the chosen set of angles, while `rotation.xvg` lists the angle with minimal potential energy.

Torque

The torque $\boldsymbol{\tau}(t)$ exerted by the rotation potential is calculated for fixed axis rotation via

$$\boldsymbol{\tau}(t) = \sum_{i=1}^N \mathbf{r}_i(t) \times \mathbf{f}_i^\perp(t), \quad (6.58)$$

where $\mathbf{r}_i(t)$ is the distance vector from the rotation axis to $\mathbf{x}_i(t)$ and $\mathbf{f}_i^\perp(t)$ is the force component perpendicular to $\mathbf{r}_i(t)$ and $\hat{\mathbf{v}}$. For flexible axis rotation, torques τ_n are calculated for each slab using the local rotation axis of the slab and the Gaussian-weighted positions.

6.6 Calculating a PMF using the free-energy code

The free-energy coupling-parameter approach (see sec. 3.12) provides several ways to calculate potentials of mean force. A potential of mean force between two atoms can be calculated by connecting them with a harmonic potential or a constraint. For this purpose there are special potentials that avoid the generation of extra exclusions, see sec. 5.4. When the position of the minimum or the constraint length is 1 nm more in state B than in state A, the restraint or constraint force is given by $\partial H/\partial\lambda$. The distance between the atoms can be changed as a function of λ and time by setting `delta-lambda` in the `.mdp` file. The results should be identical (although not numerically due to the different implementations) to the results of the pull code with umbrella sampling and constraint pulling. Unlike the pull code, the free energy code can also handle atoms that are connected by constraints.

Potentials of mean force can also be calculated using position restraints. With position restraints, atoms can be linked to a position in space with a harmonic potential (see 4.3.1). These positions can be made a function of the coupling parameter λ . The positions for the A and the B states are supplied to `grompp` with the `-r` and `-rb` options, respectively. One could use this approach to do targeted MD; note that we do not encourage the use of targeted MD for proteins. A protein can be forced from one conformation to another by using these conformations as position restraint coordinates for state A and B. One can then slowly change λ from 0 to 1. The main drawback of this approach is that the conformational freedom of the protein is severely limited by the position restraints, independent of the change from state A to B. Also, the protein is forced from state A to B in an almost straight line, whereas the real pathway might be very different. An example of a more fruitful application is a solid system or a liquid confined between walls where one wants to measure the force required to change the separation between the boundaries or walls. Because the boundaries (or walls) already need to be fixed, the position restraints do not limit the system in its sampling.

6.7 Removing fastest degrees of freedom

The maximum time step in MD simulations is limited by the smallest oscillation period that can be found in the simulated system. Bond-stretching vibrations are in their quantum-mechanical ground state and are therefore better represented by a constraint instead of a harmonic potential.

For the remaining degrees of freedom, the shortest oscillation period (as measured from a simulation) is 13 fs for bond-angle vibrations involving hydrogen atoms. Taking as a guideline that with a Verlet (leap-frog) integration scheme a minimum of 5 numerical integration steps should be performed per period of a harmonic oscillation in order to integrate it with reasonable accuracy, the maximum time step will be about 3 fs. Disregarding these very fast oscillations of period 13 fs, the next shortest periods are around 20 fs, which will allow a maximum time step of about 4 fs.

Removing the bond-angle degrees of freedom from hydrogen atoms can best be done by defining

them as virtual interaction sites instead of normal atoms. Whereas a normal atom is connected to the molecule with bonds, angles and dihedrals, a virtual site's position is calculated from the position of three nearby heavy atoms in a predefined manner (see also sec. 4.7). For the hydrogens in water and in hydroxyl, sulfhydryl, or amine groups, no degrees of freedom can be removed, because rotational freedom should be preserved. The only other option available to slow down these motions is to increase the mass of the hydrogen atoms at the expense of the mass of the connected heavy atom. This will increase the moment of inertia of the water molecules and the hydroxyl, sulfhydryl, or amine groups, without affecting the equilibrium properties of the system and without affecting the dynamical properties too much. These constructions will shortly be described in sec. 6.7.1 and have previously been described in full detail [132].

Using both virtual sites and modified masses, the next bottleneck is likely to be formed by the improper dihedrals (which are used to preserve planarity or chirality of molecular groups) and the peptide dihedrals. The peptide dihedral cannot be changed without affecting the physical behavior of the protein. The improper dihedrals that preserve planarity mostly deal with aromatic residues. Bonds, angles, and dihedrals in these residues can also be replaced with somewhat elaborate virtual site constructions.

All modifications described in this section can be performed using the GROMACS topology building tool `pdb2gmx`. Separate options exist to increase hydrogen masses, virtualize all hydrogen atoms, or also virtualize all aromatic residues. **Note** that when all hydrogen atoms are virtualized, those inside the aromatic residues will be virtualized as well, *i.e.* hydrogens in the aromatic residues are treated differently depending on the treatment of the aromatic residues.

Parameters for the virtual site constructions for the hydrogen atoms are inferred from the force field parameters (*vis.* bond lengths and angles) directly by `grompp` while processing the topology file. The constructions for the aromatic residues are based on the bond lengths and angles for the geometry as described in the force fields, but these parameters are hard-coded into `pdb2gmx` due to the complex nature of the construction needed for a whole aromatic group.

6.7.1 Hydrogen bond-angle vibrations

Construction of virtual sites

The goal of defining hydrogen atoms as virtual sites is to remove all high-frequency degrees of freedom from them. In some cases, not all degrees of freedom of a hydrogen atom should be removed, *e.g.* in the case of hydroxyl or amine groups the rotational freedom of the hydrogen atom(s) should be preserved. Care should be taken that no unwanted correlations are introduced by the construction of virtual sites, *e.g.* bond-angle vibration between the constructing atoms could translate into hydrogen bond-length vibration. Additionally, since virtual sites are by definition massless, in order to preserve total system mass, the mass of each hydrogen atom that is treated as virtual site should be added to the bonded heavy atom.

Taking into account these considerations, the hydrogen atoms in a protein naturally fall into several categories, each requiring a different approach (see also Fig. 6.6).

- *hydroxyl (-OH) or sulfhydryl (-SH) hydrogen*: The only internal degree of freedom in a hydroxyl group that can be constrained is the bending of the C-O-H angle. This angle is

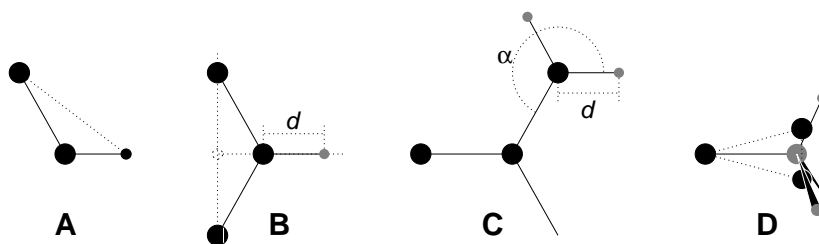

Figure 6.6: The different types of virtual site constructions used for hydrogen atoms. The atoms used in the construction of the virtual site(s) are depicted as black circles, virtual sites as gray ones. Hydrogens are smaller than heavy atoms. **A:** fixed bond angle, note that here the hydrogen is not a virtual site; **B:** in the plane of three atoms, with fixed distance; **C:** in the plane of three atoms, with fixed angle and distance; **D:** construction for amine groups ($-\text{NH}_2$ or $-\text{NH}_3^+$), see text for details.

fixed by defining an additional bond of appropriate length, see Fig. 6.6A. Doing so removes the high-frequency angle bending, but leaves the dihedral rotational freedom. The same goes for a sulfhydryl group. **Note** that in these cases the hydrogen is not treated as a virtual site.

- *single amine or amide ($-\text{NH}-$) and aromatic hydrogens ($-\text{CH}-$):* The position of these hydrogens cannot be constructed from a linear combination of bond vectors, because of the flexibility of the angle between the heavy atoms. Instead, the hydrogen atom is positioned at a fixed distance from the bonded heavy atom on a line going through the bonded heavy atom and a point on the line through both second bonded atoms, see Fig. 6.6B.
- *planar amine ($-\text{NH}_2$) hydrogens:* The method used for the single amide hydrogen is not well suited for planar amine groups, because no suitable two heavy atoms can be found to define the direction of the hydrogen atoms. Instead, the hydrogen is constructed at a fixed distance from the nitrogen atom, with a fixed angle to the carbon atom, in the plane defined by one of the other heavy atoms, see Fig. 6.6C.
- *amine group (umbrella $-\text{NH}_2$ or $-\text{NH}_3^+$) hydrogens:* Amine hydrogens with rotational freedom cannot be constructed as virtual sites from the heavy atoms they are connected to, since this would result in loss of the rotational freedom of the amine group. To preserve the rotational freedom while removing the hydrogen bond-angle degrees of freedom, two “dummy masses” are constructed with the same total mass, moment of inertia (for rotation around the C-N bond) and center of mass as the amine group. These dummy masses have no interaction with any other atom, except for the fact that they are connected to the carbon and to each other, resulting in a rigid triangle. From these three particles, the positions of the nitrogen and hydrogen atoms are constructed as linear combinations of the two carbon-mass vectors and their outer product, resulting in an amine group with rotational freedom intact, but without other internal degrees of freedom. See Fig. 6.6D.

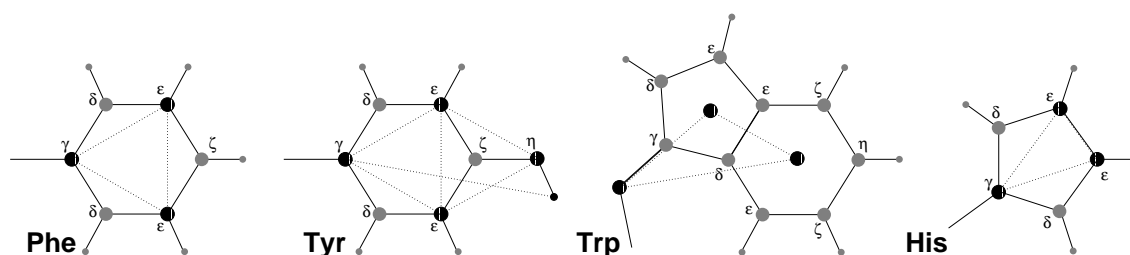

Figure 6.7: The different types of virtual site constructions used for aromatic residues. The atoms used in the construction of the virtual site(s) are depicted as black circles, virtual sites as gray ones. Hydrogens are smaller than heavy atoms. A: phenylalanine; B: tyrosine (note that the hydroxyl hydrogen is *not* a virtual site); C: tryptophan; D: histidine.

6.7.2 Out-of-plane vibrations in aromatic groups

The planar arrangements in the side chains of the aromatic residues lends itself perfectly to a virtual-site construction, giving a perfectly planar group without the inherently unstable constraints that are necessary to keep normal atoms in a plane. The basic approach is to define three atoms or dummy masses with constraints between them to fix the geometry and create the rest of the atoms as simple virtual sites type (see sec. 4.7) from these three. Each of the aromatic residues require a different approach:

- *Phenylalanine*: C_γ , $C_{\epsilon 1}$, and $C_{\epsilon 2}$ are kept as normal atoms, but with each a mass of one third the total mass of the phenyl group. See Fig. 6.6A.
- *Tyrosine*: The ring is treated identically to the phenylalanine ring. Additionally, constraints are defined between $C_{\epsilon 1}$, $C_{\epsilon 2}$, and O_η . The original improper dihedral angles will keep both triangles (one for the ring and one with O_η) in a plane, but due to the larger moments of inertia this construction will be much more stable. The bond-angle in the hydroxyl group will be constrained by a constraint between C_γ and H_η . **Note** that the hydrogen is not treated as a virtual site. See Fig. 6.6B.
- *Tryptophan*: C_β is kept as a normal atom and two dummy masses are created at the center of mass of each of the rings, each with a mass equal to the total mass of the respective ring ($C_{\delta 2}$ and $C_{\epsilon 2}$ are each counted half for each ring). This keeps the overall center of mass and the moment of inertia almost (but not quite) equal to what it was. See Fig. 6.6C.
- *Histidine*: C_γ , $C_{\epsilon 1}$ and $N_{\epsilon 2}$ are kept as normal atoms, but with masses redistributed such that the center of mass of the ring is preserved. See Fig. 6.6D.

6.8 Viscosity calculation

The shear viscosity is a property of liquids that can be determined easily by experiment. It is useful for parameterizing a force field because it is a kinetic property, while most other properties which are used for parameterization are thermodynamic. The viscosity is also an important property, since it influences the rates of conformational changes of molecules solvated in the liquid.

The viscosity can be calculated from an equilibrium simulation using an Einstein relation:

$$\eta = \frac{1}{2} \frac{V}{k_B T} \lim_{t \rightarrow \infty} \frac{d}{dt} \left\langle \left(\int_{t_0}^{t_0+t} P_{xz}(t') dt' \right)^2 \right\rangle_{t_0} \quad (6.59)$$

This can be done with `g_energy`. This method converges very slowly [133], and as such a nanosecond simulation might not be long enough for an accurate determination of the viscosity. The result is very dependent on the treatment of the electrostatics. Using a (short) cut-off results in large noise on the off-diagonal pressure elements, which can increase the calculated viscosity by an order of magnitude.

GROMACS also has a non-equilibrium method for determining the viscosity [133]. This makes use of the fact that energy, which is fed into system by external forces, is dissipated through viscous friction. The generated heat is removed by coupling to a heat bath. For a Newtonian liquid adding a small force will result in a velocity gradient according to the following equation:

$$a_x(z) + \frac{\eta}{\rho} \frac{\partial^2 v_x(z)}{\partial z^2} = 0 \quad (6.60)$$

Here we have applied an acceleration $a_x(z)$ in the x -direction, which is a function of the z -coordinate. In GROMACS the acceleration profile is:

$$a_x(z) = A \cos\left(\frac{2\pi z}{l_z}\right) \quad (6.61)$$

where l_z is the height of the box. The generated velocity profile is:

$$v_x(z) = V \cos\left(\frac{2\pi z}{l_z}\right) \quad (6.62)$$

$$V = A \frac{\rho}{\eta} \left(\frac{l_z}{2\pi}\right)^2 \quad (6.63)$$

The viscosity can be calculated from A and V :

$$\eta = \frac{A}{V} \rho \left(\frac{l_z}{2\pi}\right)^2 \quad (6.64)$$

In the simulation V is defined as:

$$V = \frac{\sum_{i=1}^N m_i v_{i,x} \cos\left(\frac{2\pi z}{l_z}\right)}{\sum_{i=1}^N m_i} \quad (6.65)$$

The generated velocity profile is not coupled to the heat bath. Moreover, the velocity profile is excluded from the kinetic energy. One would like V to be as large as possible to get good statistics. However, the shear rate should not be so high that the system gets too far from equilibrium. The maximum shear rate occurs where the cosine is zero, the rate being:

$$\text{sh}_{\max} = \max_z \left| \frac{\partial v_x(z)}{\partial z} \right| = A \frac{\rho}{\eta} \frac{l_z}{2\pi} \quad (6.66)$$

For a simulation with: $\eta = 10^{-3}$ [kg m⁻¹ s⁻¹], $\rho = 10^3$ [kg m⁻³] and $l_z = 2\pi$ [nm], $sh_{\max} = 1$ [ps nm⁻¹] A . This shear rate should be smaller than one over the longest correlation time in the system. For most liquids, this will be the rotation correlation time, which is around 10 ps. In this case, A should be smaller than 0.1 [nm ps⁻²]. When the shear rate is too high, the observed viscosity will be too low. Because V is proportional to the square of the box height, the optimal box is elongated in the z -direction. In general, a simulation length of 100 ps is enough to obtain an accurate value for the viscosity.

The heat generated by the viscous friction is removed by coupling to a heat bath. Because this coupling is not instantaneous the real temperature of the liquid will be slightly lower than the observed temperature. Berendsen derived this temperature shift [30], which can be written in terms of the shear rate as:

$$T_s = \frac{\eta \tau}{2\rho C_v} sh_{\max}^2 \quad (6.67)$$

where τ is the coupling time for the Berendsen thermostat and C_v is the heat capacity. Using the values of the example above, $\tau = 10^{-13}$ [s] and $C_v = 2 \cdot 10^3$ [J kg⁻¹ K⁻¹], we get: $T_s = 25$ [K ps⁻²] sh_{\max}^2 . When we want the shear rate to be smaller than 1/10 [ps⁻¹], T_s is smaller than 0.25 [K], which is negligible.

Note that the system has to build up the velocity profile when starting from an equilibrium state. This build-up time is of the order of the correlation time of the liquid.

Two quantities are written to the energy file, along with their averages and fluctuations: V and $1/\eta$, as obtained from (6.64).

6.9 Tabulated interaction functions

6.9.1 Cubic splines for potentials

In some of the inner loops of GROMACS, look-up tables are used for computation of potential and forces. The tables are interpolated using a cubic spline algorithm. There are separate tables for electrostatic, dispersion, and repulsion interactions, but for the sake of caching performance these have been combined into a single array. The cubic spline interpolation for $x_i \leq x < x_{i+1}$ looks like this:

$$V_s(x) = A_0 + A_1 \epsilon + A_2 \epsilon^2 + A_3 \epsilon^3 \quad (6.68)$$

where the table spacing h and fraction ϵ are given by:

$$h = x_{i+1} - x_i \quad (6.69)$$

$$\epsilon = (x - x_i)/h \quad (6.70)$$

so that $0 \leq \epsilon < 1$. From this, we can calculate the derivative in order to determine the forces:

$$-V'_s(x) = -\frac{dV_s(x)}{d\epsilon} \frac{d\epsilon}{dx} = -(A_1 + 2A_2 \epsilon + 3A_3 \epsilon^2)/h \quad (6.71)$$

The four coefficients are determined from the four conditions that V_s and $-V'_s$ at both ends of each interval should match the exact potential V and force $-V'$. This results in the following errors for

each interval:

$$|V_s - V|_{max} = V'''' \frac{h^4}{384} + O(h^5) \quad (6.72)$$

$$|V'_s - V'|_{max} = V'''' \frac{h^3}{72\sqrt{3}} + O(h^4) \quad (6.73)$$

$$|V''_s - V''|_{max} = V'''' \frac{h^2}{12} + O(h^3) \quad (6.74)$$

V and V' are continuous, while V'' is the first discontinuous derivative. The number of points per nanometer is 500 and 2000 for single- and double-precision versions of GROMACS, respectively. This means that the errors in the potential and force will usually be smaller than the single precision accuracy.

GROMACS stores A_0 , A_1 , A_2 and A_3 . The force routines get a table with these four parameters and a scaling factor s that is equal to the number of points per nm. (**Note** that h is s^{-1}). The algorithm goes a little something like this:

1. Calculate distance vector (\mathbf{r}_{ij}) and distance r_{ij}
2. Multiply r_{ij} by s and truncate to an integer value n_0 to get a table index
3. Calculate fractional component ($\epsilon = sr_{ij} - n_0$) and ϵ^2
4. Do the interpolation to calculate the potential V and the scalar force f
5. Calculate the vector force \mathbf{F} by multiplying f with \mathbf{r}_{ij}

Note that table look-up is significantly *slower* than computation of the most simple Lennard-Jones and Coulomb interaction. However, it is much faster than the shifted Coulomb function used in conjunction with the PPPM method. Finally, it is much easier to modify a table for the potential (and get a graphical representation of it) than to modify the inner loops of the MD program.

6.9.2 User-specified potential functions

You can also use your own s without editing the GROMACS code. The potential function should be according to the following equation

$$V(r_{ij}) = \frac{q_i q_j}{4\pi\epsilon_0} f(r_{ij}) + C_6 g(r_{ij}) + C_{12} h(r_{ij}) \quad (6.75)$$

where f , g , and h are user defined functions. **Note** that if $g(r)$ represents a normal dispersion interaction, $g(r)$ should be < 0 . C_6 , C_{12} and the charges are read from the topology. Also note that combination rules are only supported for Lennard-Jones and Buckingham, and that your tables should match the parameters in the binary topology.

When you add the following lines in your `.mdp` file:

```
rlist           = 1.0
coulombtype     = User
rcoulomb       = 1.0
vdwtype        = User
rvdw           = 1.0
```

`mdrun` will read a single non-bonded table file, or multiple when `energygrp-table` is set (see below). The name of the file(s) can be set with the `mdrun` option `-table`. The table file should contain seven columns of table look-up data in the order: x , $f(x)$, $-f'(x)$, $g(x)$, $-g'(x)$, $h(x)$, $-h'(x)$. The x should run from 0 to $r_c + 1$ (the value of `table_extension` can be changed in the `.mdp` file). You can choose the spacing you like; for the standard tables GROMACS uses a spacing of 0.002 and 0.0005 nm when you run in single and double precision, respectively. In this context, r_c denotes the maximum of the two cut-offs `rvdw` and `rcoulomb` (see above). These variables need not be the same (and need not be 1.0 either). Some functions used for potentials contain a singularity at $x = 0$, but since atoms are normally not closer to each other than 0.1 nm, the function value at $x = 0$ is not important. Finally, it is also possible to combine a standard Coulomb with a modified LJ potential (or vice versa). One then specifies *e.g.* `coulombtype = Cut-off` or `coulombtype = PME`, combined with `vdwtype = User`. The table file must always contain the 7 columns however, and meaningful data (i.e. not zeroes) must be entered in all columns. A number of pre-built table files can be found in the `GMXLIB` directory for 6-8, 6-9, 6-10, 6-11, and 6-12 Lennard-Jones potentials combined with a normal Coulomb.

If you want to have different functional forms between different groups of atoms, this can be set through energy groups. Different tables can be used for non-bonded interactions between different energy groups pairs through the `.mdp` option `energygrp-table` (see sec. 7.3). Atoms that should interact with a different potential should be put into different energy groups. Between group pairs which are not listed in `energygrp-table`, the normal user tables will be used. This makes it easy to use a different functional form between a few types of atoms.

6.10 Mixed Quantum-Classical simulation techniques

In a molecular mechanics (MM) force field, the influence of electrons is expressed by empirical parameters that are assigned on the basis of experimental data, or on the basis of results from high-level quantum chemistry calculations. These are valid for the ground state of a given covalent structure, and the MM approximation is usually sufficiently accurate for ground-state processes in which the overall connectivity between the atoms in the system remains unchanged. However, for processes in which the connectivity does change, such as chemical reactions, or processes that involve multiple electronic states, such as photochemical conversions, electrons can no longer be ignored, and a quantum mechanical description is required for at least those parts of the system in which the reaction takes place.

One approach to the simulation of chemical reactions in solution, or in enzymes, is to use a combination of quantum mechanics (QM) and molecular mechanics (MM). The reacting parts of the system are treated quantum mechanically, with the remainder being modeled using the force field. The current version of GROMACS provides interfaces to several popular Quantum Chemistry packages (MOPAC [134], GAMESS-UK [135], Gaussian [136] and CPMD [137]).

GROMACS interactions between the two subsystems are either handled as described by Field *et al.* [138] or within the ONIOM approach by Morokuma and coworkers [139, 140].

6.10.1 Overview

Two approaches for describing the interactions between the QM and MM subsystems are supported in this version:

1. **Electronic Embedding** The electrostatic interactions between the electrons of the QM region and the MM atoms and between the QM nuclei and the MM atoms are included in the Hamiltonian for the QM subsystem:

$$H^{QM/MM} = H_e^{QM} - \sum_i^n \sum_J^M \frac{e^2 Q_J}{4\pi\epsilon_0 r_{iJ}} + \sum_A^N \sum_J^M \frac{e^2 Z_A Q_J}{e\pi\epsilon_0 R_{AJ}}, \quad (6.76)$$

where n and N are the number of electrons and nuclei in the QM region, respectively, and M is the number of charged MM atoms. The first term on the right hand side is the original electronic Hamiltonian of an isolated QM system. The first of the double sums is the total electrostatic interaction between the QM electrons and the MM atoms. The total electrostatic interaction of the QM nuclei with the MM atoms is given by the second double sum. Bonded interactions between QM and MM atoms are described at the MM level by the appropriate force field terms. Chemical bonds that connect the two subsystems are capped by a hydrogen atom to complete the valence of the QM region. The force on this atom, which is present in the QM region only, is distributed over the two atoms of the bond. The cap atom is usually referred to as a link atom.

2. **ONIOM** In the ONIOM approach, the energy and gradients are first evaluated for the isolated QM subsystem at the desired level of *ab initio* theory. Subsequently, the energy and gradients of the total system, including the QM region, are computed using the molecular mechanics force field and added to the energy and gradients calculated for the isolated QM subsystem. Finally, in order to correct for counting the interactions inside the QM region twice, a molecular mechanics calculation is performed on the isolated QM subsystem and the energy and gradients are subtracted. This leads to the following expression for the total QM/MM energy (and gradients likewise):

$$E_{tot} = E_I^{QM} + E_{I+II}^{MM} - E_I^{MM}, \quad (6.77)$$

where the subscripts I and II refer to the QM and MM subsystems, respectively. The superscripts indicate at what level of theory the energies are computed. The ONIOM scheme has the advantage that it is not restricted to a two-layer QM/MM description, but can easily handle more than two layers, with each layer described at a different level of theory.

6.10.2 Usage

To make use of the QM/MM functionality in GROMACS, one needs to:

1. introduce link atoms at the QM/MM boundary, if needed;
2. specify which atoms are to be treated at a QM level;
3. specify the QM level, basis set, type of QM/MM interface and so on.

Adding link atoms

At the bond that connects the QM and MM subsystems, a link atom is introduced. In GROMACS the link atom has special atomtype, called LA. This atomtype is treated as a hydrogen atom in the QM calculation, and as a virtual site in the force field calculation. The link atoms, if any, are part of the system, but have no interaction with any other atom, except that the QM force working on it is distributed over the two atoms of the bond. In the topology, the link atom (LA), therefore, is defined as a virtual site atom:

```
[ virtual_sites2 ]  
LA QMatom MMatom 1 0.65
```

See sec. 5.2.2 for more details on how virtual sites are treated. The link atom is replaced at every step of the simulation.

In addition, the bond itself is replaced by a constraint:

```
[ constraints ]  
QMatom MMatom 2 0.153
```

Note that, because in our system the QM/MM bond is a carbon-carbon bond (0.153 nm), we use a constraint length of 0.153 nm, and dummy position of 0.65. The latter is the ratio between the ideal C-H bond length and the ideal C-C bond length. With this ratio, the link atom is always 0.1 nm away from the QMatom, consistent with the carbon-hydrogen bond length. If the QM and MM subsystems are connected by a different kind of bond, a different constraint and a different dummy position, appropriate for that bond type, are required.

Specifying the QM atoms

Atoms that should be treated at a QM level of theory, including the link atoms, are added to the index file. In addition, the chemical bonds between the atoms in the QM region are to be defined as connect bonds (bond type 5) in the topology file:

```
[ bonds ]  
QMatom1 QMatom2 5  
QMatom2 QMatom3 5
```

Specifying the QM/MM simulation parameters

In the .mdp file, the following parameters control a QM/MM simulation.

```
QMMM = no
```

If this is set to `yes`, a QM/MM simulation is requested. Several groups of atoms can be described at different QM levels separately. These are specified in the `QMMM-grps` field separated by spaces. The level of *ab initio* theory at which the groups are described is specified by `QMmethod` and `QMbasis` fields. Describing the groups at different levels of theory is only possible with the ONIOM QM/MM scheme, specified by `QMMMscheme`.

`QMMM-grps =`
groups to be described at the QM level

`QMMMScheme = normal`

Options are `normal` and `ONIOM`. This selects the QM/MM interface. `normal` implies that the QM subsystem is electronically embedded in the MM subsystem. There can only be one `QMMM-grps` that is modeled at the `QMmethod` and `QMbasis` level of *ab initio* theory. The rest of the system is described at the MM level. The QM and MM subsystems interact as follows: MM point charges are included in the QM one-electron Hamiltonian and all Lennard-Jones interactions are described at the MM level. If `ONIOM` is selected, the interaction between the subsystem is described using the ONIOM method by Morokuma and co-workers. There can be more than one `QMMM-grps` each modeled at a different level of QM theory (`QMmethod` and `QMbasis`).

`QMmethod =`

Method used to compute the energy and gradients on the QM atoms. Available methods are AM1, PM3, RHF, UHF, DFT, B3LYP, MP2, CASSCF, MMVB and CPMD. For CASSCF, the number of electrons and orbitals included in the active space is specified by `CASelectrons` and `CASorbitals`. For CPMD, the plane-wave cut-off is specified by the `planewavecutoff` keyword.

`QMbasis =`

Gaussian basis set used to expand the electronic wave-function. Only Gaussian basis sets are currently available, i.e. STO-3G, 3-21G, 3-21G*, 3-21+G*, 6-21G, 6-31G, 6-31G*, 6-31+G*, and 6-311G. For CPMD, which uses plane wave expansion rather than atom-centered basis functions, the `planewavecutoff` keyword controls the plane wave expansion.

`QMcharge =`

The total charge in *e* of the `QMMM-grps`. In case there are more than one `QMMM-grps`, the total charge of each ONIOM layer needs to be specified separately.

`QMmult =`

The multiplicity of the `QMMM-grps`. In case there are more than one `QMMM-grps`, the multiplicity of each ONIOM layer needs to be specified separately.

`CASorbitals =`

The number of orbitals to be included in the active space when doing a CASSCF computation.

`CASelectrons =`

The number of electrons to be included in the active space when doing a CASSCF computation.

`SH = no`

If this is set to `yes`, a QM/MM MD simulation on the excited state-potential energy surface and enforce a diabatic hop to the ground-state when the system hits the conical intersection hyperline in the course the simulation. This option only works in combination with the CASSCF method.

6.10.3 Output

The energies and gradients computed in the QM calculation are added to those computed by GRO-MACS. In the `.edr` file there is a section for the total QM energy.

6.10.4 Future developments

Several features are currently under development to increase the accuracy of the QM/MM interface. One useful feature is the use of delocalized MM charges in the QM computations. The most important benefit of using such smeared-out charges is that the Coulombic potential has a finite value at interatomic distances. In the point charge representation, the partially-charged MM atoms close to the QM region tend to “over-polarize” the QM system, which leads to artifacts in the calculation.

What is needed as well is a transition state optimizer.

6.11 Adaptive Resolution Scheme

The adaptive resolution scheme [141, 142] (AdResS) couples two systems with different resolutions by a force interpolation scheme. In contrast to the mixed Quantum-Classical simulation techniques of the previous section, the number of high resolution particles is not fixed, but can vary over the simulation time.

Below we discuss AdResS for a double resolution (atomistic and coarse grained) representation of the same system. See Fig. 6.8 for illustration. The details of implementation described in this section were published in [143, 144].

Every molecule needs a well-defined mapping point (usually the center of mass) but any other linear combination of particle coordinates is also sufficient. In the topology the mapping point is defined by a virtual site. The forces in the coarse-grained region are functions of the mapping point positions only. In this implementation molecules are modeled by charge groups or sets of charge groups, which actually allows one to have multiple mapping points per molecule. This can be useful for bigger molecules like polymers. In that case one has to also extend the AdResS description to bonded interactions [145], which will be implemented into GROMACS in one of the future versions.

The force between two molecules is given by [141]¹:

$$\vec{F}_{\alpha\beta} = w_{\alpha}w_{\beta}\vec{F}_{\alpha\beta}^{\text{ex,mol}} + [1 - w_{\alpha}w_{\beta}]\vec{F}_{\alpha\beta}^{\text{cg,mol}}, \quad (6.78)$$

where α and β label the two molecules and w_{α} , w_{β} are the adaptive weights of the two molecules.

The first part, which represents the explicit interaction of the molecules, can be written as:

$$\vec{F}_{\alpha\beta}^{\text{ex,mol}} = \sum_{i \in \alpha} \sum_{j \in \beta} \vec{F}_{ij}^{\text{ex}}, \quad (6.79)$$

¹Note that the equation obeys Newton’s third law, which is not the case for other interpolation schemes [146].

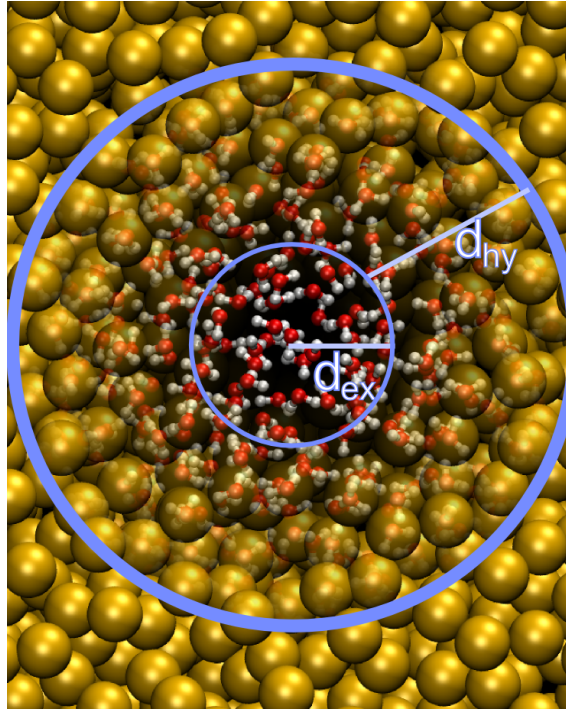

Figure 6.8: A schematic illustration of the AdResS method for water.

where \vec{F}_{ij}^{ex} is the force between the i th atom in α th molecule and the j th atom in the β th molecule, which is given by an explicit force field. The second part of eqn. 6.78 comes from the coarse-grained interaction of the molecules. In GROMACSa slightly extended case is implemented:

$$\vec{F}_{\alpha\beta} = \sum_{i \in \alpha} \sum_{j \in \beta} w_i w_j \vec{F}_{ij}^{\text{ex}} + [1 - w_\alpha w_\beta] \vec{F}_{\alpha\beta}^{\text{cg,mol}}, \quad (6.80)$$

where w_i and w_j are atom-wise weights, which are determined by the `address-site` option. For `address-site` being the center of mass, atom i has the weight of the center of mass of its *charge group*. The weight w_α of molecule α is determined by the position of coarse-grained particle, which is constructed as a virtual site from the atomistic particles as specified in the topology. This extension allows one to perform all kind of AdResS variations, but the common case can be recovered by using a center of mass virtual site in the topology, `address-site=COM` and putting all atoms (except the virtual site representing the coarse-grained interaction) of a molecule into one charge group. For big molecules, it is sometimes useful to use an atom-based weight, which can be either be achieved by setting `address-site=atomperatom` or putting every atom into a separate charge group (the center of mass of a charge group with one atom is the atom itself).

The coarse-grained force field \vec{F}^{cg} is usually derived from the atomistic system by structure-based coarse-graining (see sec. 4.10.6). To specify which atoms belong to a coarse-grained representation, energy groups are used. Each coarse-grained interaction has to be associated with a specific energy group, which is why the virtual sites representing the coarse-grained interactions also have to be in different charge groups. The energy groups which are treated as coarse-grained interactions are then listed in `address_cg_grp_names`. The most important element of this

interpolation (see eqn. 6.78 and eqn. 6.80) is the adaptive weighting function (for illustration see Fig. 6.8):

$$w(x) = \begin{cases} 1 & : \text{atomistic/explicit region} \\ 0 < w < 1 & : \text{hybrid region} \\ 0 & : \text{coarse - grained region} \end{cases}, \quad (6.81)$$

which has a value between 0 and 1. This definition of w gives a purely explicit force in the explicit region and a purely coarse-grained force in the coarse-grained region, so essentially eqn. 6.78 only the hybrid region has mixed interactions which would not appear in a standard simulation. In GROMACS, a \cos^2 -like function is implemented as a weighting function:

$$w(x) = \begin{cases} 0 & : x > d_{\text{ex}} + d_{\text{hy}} \\ \cos^2\left(\frac{\pi}{2d_{\text{hy}}}(x - d_{\text{ex}})\right) & : d_{\text{ex}} + d_{\text{hy}} > x > d_{\text{ex}} \\ 1 & : d_{\text{ex}} > x \end{cases}, \quad (6.82)$$

where d_{ex} and d_{hy} are the sizes of the explicit and the hybrid region, respectively. Depending on the physical interest of the research, other functions could be implemented as long as the following boundary conditions are fulfilled: The function is 1) continuous, 2) monotonic and 3) has zero derivatives at the boundaries. Spherical and one-dimensional splitting of the simulation box has been implemented (`adress-type` option) and depending on this, the distance x to the center of the explicit region is calculated as follows:

$$x = \begin{cases} |(\vec{R}_\alpha - \vec{R}_{\text{ct}}) \cdot \hat{e}| & : \text{splitting in } \hat{e} \text{ direction} \\ |\vec{R}_\alpha - \vec{R}_{\text{ct}}| & : \text{spherical splitting} \end{cases}, \quad (6.83)$$

where \vec{R}_{ct} is the center of the explicit zone (defined by `adress-reference-coords` option). \vec{R}_α is the mapping point of the α th molecule. For the center of mass mapping, it is given by:

$$R_\alpha = \frac{\sum_{i \in \alpha} m_i r_i}{\sum_{i \in \alpha} m_i} \quad (6.84)$$

Note that the value of the weighting function depends exclusively on the mapping of the molecule. The interpolation of forces (see eqn. 6.80) can produce inhomogeneities in the density and affect the structure of the system in the hybrid region.

One way of reducing the density inhomogeneities is by the application of the so-called thermodynamic force (TF) [147]. Such a force consists of a space-dependent external field applied in the hybrid region on the coarse-grained site of each molecule. It can be specified for each of the species of the system. The TF compensates the pressure profile [148] that emerges under a homogeneous density profile. Therefore, it can correct the local density inhomogeneities in the hybrid region and it also allows the coupling of atomistic and coarse-grained representations which by construction have different pressures at the target density. The field can be determined by an iterative procedure, which is described in detail in the [manual](#) of the VOTCA package [120]. Setting the `adress-interface-correction` to `thermoforce` enables the TF correction and `adress-tf-grp-names` defines the energy groups to act on.

6.11.1 Example: Adaptive resolution simulation of water

In this section the set up of an adaptive resolution simulation coupling atomistic SPC [80] water to its coarse-grained representation will be explained (as used in [148]). The following steps are required to setup the simulation:

- Perform a reference all-atom simulation
- Create a coarse-grained representation and save it as tabulated interaction function
- Create a hybrid topology for the SPC water
- Modify the atomistic coordinate file to include the coarse grained representation
- Define the geometry of the adaptive simulation in the grompp input file
- Create an index file

The coarse-grained representation of the interaction is stored as tabulated interaction function see 6.9.2. The convention is to use the $C^{(12)}$ columns with the $C^{(12)}$ -coefficient set to 1. All other columns should be zero. The VOTCA manual has detailed instructions and a tutorial for SPC water on how to coarse-grain the interaction using various techniques. Here we named the coarse grained interaction CG, so the corresponding tabulated file is `table_CG_CG.xvg`. To create the topology one can start from the atomistic topology file (e.g. `share/gromacs/top/oplsaa.ff/spc.itp`), we are assuming rigid water here. In the VOTCA tutorial the file is named `hybrid_spc.itp`. The only difference to the atomistic topology is the addition of a coarse-grained virtual site:

```
[ moleculetype ]
; molname          nrexcl
SOL                 2

[ atoms ]
;  nr   type  resnr  residue  atom   cgnr   charge   mass
   1  opl_116   1     SOL     OW     1     -0.82
   2  opl_117   1     SOL     HW1    1      0.41
   3  opl_117   1     SOL     HW2    1      0.41
   4   CG      1     SOL     CG     2      0

[ settles ]
; OW   funct   doh    dhh
1     1       0.1    0.16330

[ exclusions ]
1     2       3
2     1       3
3     1       2

[ virtual_sites3 ]
; Site from funct a d
4 1 2 3 1 0.05595E+00 0.05595E+00
```

The virtual site type 3 with the specified coefficients places the virtual site in the center of mass of the molecule (for larger molecules `virtual_sitesn` has to be used). We now need to include our modified water model in the topology file and define the type CG. In `topol.top`:

```
#include "ffoplsaa.itp"

[ atomtypes ]
;name mass      charge   ptype   sigma   epsilon
  CG    0.00000    0.0000  V       1      0.25

#include "hybrid_spc.itp"

[ system ]
Adaptive water
[ molecules ]
SOL      8507
```

The σ and ϵ values correspond to $C_6 = 1$ and $C_{12} = 1$ and thus the table file should contain the coarse-grained interaction in either the C_6 or C_{12} column. In the example the OPLS force field is used where σ and ϵ are specified. Note that for force fields which define atomtypes directly in terms of C_6 and C_{12} (like `gmx.ff`) one can simply set $C_6 = 0$ and $C_{12} = 1$. See section 6.9.2 for more details on tabulated interactions. Since now the water molecule has a virtual site the coordinate file also needs to include that.

```
adaptive water coordinates
34028
  1SOL    OW    1    0.283    0.886    0.647
  1SOL    HW1   2    0.359    0.884    0.711
  1SOL    HW2   3    0.308    0.938    0.566
  1SOL    CG    4    0.289    0.889    0.646
  1SOL    OW    5    1.848    0.918    0.082
  1SOL    HW1   6    1.760    0.930    0.129
  1SOL    HW2   7    1.921    0.912    0.150
  1SOL    CG    8    1.847    0.918    0.088
  (...)
```

This file can be created manually or using the VOTCA tool `csg_map` with the `--hybrid` option.

In the `grompp` input file the AdResS feature needs to be enabled and the geometry defined.

```
(...)
; AdResS relevant options
energygrps          = CG
energygrp_table     = CG CG

; Method for doing Van der Waals
vdw-type            = user

adress              = yes
adress_type         = xsplit
adress_ex_width     = 1.5
adress_hy_width     = 1.5
```

```
adress_interface_correction = off
adress_reference_coords = 8 0 0
adress_cg_grp_names = CG
```

Here we are defining an energy group CG which consists of the coarse-grained virtual site. As discussed above, the coarse-grained interaction is usually tabulated. This requires the `vdw-type` parameter to be set to `user`. In the case where multi-component systems are coarse-grained, an energy group has to be defined for each component. Note that all the energy groups defining coarse-grained representations have to be listed again in `adress_cg_grp_names` to distinguish them from regular energy groups.

The index file has to be updated to have a group CG which includes all the coarse-grained virtual sites. This can be done easily using the `make_ndx` tool of `gromacs`.

Chapter 7

Run parameters and Programs

7.1 On-line and HTML manuals

All the information in this chapter can also be found in HTML format in your GROMACS data directory. The path depends on where your files are installed, but the default location is

```
/usr/local/gromacs/share/html/online.html
```

Or, if you installed from Linux packages it can be found as

```
/usr/local/share/gromacs/html/online.html
```

You can also use the online from our web site,

<http://manual.gromacs.org/current/>

In addition, we install standard UNIX manuals for all the programs. If you have sourced the GMXRC script in the GROMACS binary directory for your host they should already be present in your \$MANPATH, and you should be able to type *e.g.* `man grompp`.

The program manual pages can also be found in Appendix D in this manual.

7.2 File types

Table 7.1 lists the file types used by GROMACS along with a short description, and you can find a more detail description for each file in your HTML reference, or in our online version.

GROMACS files written in XDR format can be read on any architecture with GROMACS version 1.6 or later if the configuration script found the XDR libraries on your system. They should always be present on UNIX since they are necessary for NFS support.

Default Name	Ext.	Type	Default Option	Description
atomtp.atp		Asc		Atomtype file used by pdb2gmx
eiwit.brk		Asc	-f	Brookhaven data bank file
state.cpt		xdr		Checkpoint file
nndice.dat		Asc		Generic data file
user.dlg		Asc		Dialog Box data for ngmx
sam.edi		Asc		ED sampling input
sam.edo		Asc		ED sampling output
ener.edr				Generic energy: edr ene
ener.edr		xdr		Energy file in portable xdr format
ener.ene		Bin		Energy file
eiwit.ent		Asc	-f	Entry in the protein date bank
plot.eps		Asc		Encapsulated PostScript (tm) file
conf.esp		Asc	-c	Coordinate file in ESPResSo format
gtraj.g87		Asc		Gromos-87 ASCII trajectory format
conf.g96		Asc	-c	Coordinate file in Gromos-96 format
conf.gro		Asc	-c	Coordinate file in Gromos-87 format
conf.gro			-c	Structure: gro g96 pdb esp tpr tpb tpa
out.gro			-o	Structure: gro g96 pdb esp
polar.hdb		Asc		Hydrogen data base
topinc.itp		Asc		Include file for topology
run.log		Asc	-l	Log file
ps.m2p		Asc		Input file for mat2ps
ss.map		Asc		File that maps matrix data to colors
ss.mat		Asc		Matrix Data file
grompp.mdp		Asc	-f	grompp input file with MD parameters
hessian.mtx		Bin	-m	Hessian matrix
index.ndx		Asc	-n	Index file
hello.out		Asc	-o	Generic output file
eiwit.pdb		Asc	-f	Protein data bank file
residue.rtp		Asc		Residue Type file used by pdb2gmx
doc.tex		Asc	-o	LaTeX file
topol.top		Asc	-p	Topology file
topol.tpb		Bin	-s	Binary run input file
topol.tpr			-s	Generic run input: tpr tpb tpa
topol.tpr			-s	Structure+mass(db): tpr tpb tpa gro g96 pdb
topol.tpr		xdr	-s	Portable xdr run input file
traj.trj		Bin		Trajectory file (architecture specific)
traj.trr				Full precision trajectory: trr trj cpt
traj.trr		xdr		Trajectory in portable xdr format
root.xpm		Asc		X PixMap compatible matrix file
traj.xtc			-f	Trajec., input: xtc trr trj cpt gro g96 pdb
traj.xtc			-f	Trajectory, output: xtc trr trj gro g96 pdb
traj.xtc		xdr		Compressed trajectory (portable xdr format)
graph.xvg		Asc	-o	xvgr/xmgr file

Table 7.1: The GROMACS file types.

7.3 Run Parameters

7.3.1 General

Default values are given in parentheses. The first option in the list is always the default option. Units are given in square brackets. The difference between a dash and an underscore is ignored. A sample `.mdp` file is available. This should be appropriate to start a normal simulation. Edit it to suit your specific needs and desires.

7.3.2 Preprocessing

include:

directories to include in your topology. Format:
`-I/home/john/mylib -I../otherlib`

define:

defines to pass to the preprocessor, default is no defines. You can use any defines to control options in your customized topology files. Options that are already available by default are:

-DFLEXIBLE

Will tell `grompp` to include flexible water in stead of rigid water into your topology, this can be useful for normal mode analysis.

-DPOSRES

Will tell `grompp` to include `posre.itp` into your topology, used for position restraints.

7.3.3 Run control

integrator: (Despite the name, this list includes algorithms that are not actually integrators. `steep` and all entries following it are in this category)

md

A leap-frog algorithm for integrating Newton's equations of motion.

md-vv

A velocity Verlet algorithm for integrating Newton's equations of motion. For constant NVE simulations started from corresponding points in the same trajectory, the trajectories are analytically, but not binary, identical to the `md` leap-frog integrator. The kinetic energy, which is determined from the whole step velocities and is therefore slightly too high. The advantage of this integrator is more accurate, reversible Nose-Hoover and Parrinello-Rahman coupling integration based on Trotter expansion, as well as (slightly too small) full step velocity output. This all comes at the cost of extra computation, especially with constraints and extra communication in parallel. Note that for nearly all production simulations the `md` integrator is accurate enough.

md-vv-avek

A velocity Verlet algorithm identical to `md-vv`, except that the kinetic energy is determined as the average of the two half step kinetic energies as in the `md` integrator, and this thus more accurate. With Nose-Hoover and/or Parrinello-Rahman coupling this comes with a slight increase in computational cost.

sd

An accurate leap-frog stochastic dynamics integrator. Four Gaussian random number are required per integration step per degree of freedom. With constraints, coordinates needs to be constrained twice per integration step. Depending on the computational cost of the force calculation, this can take a significant part of the simulation time. The temperature for one or more groups of atoms (`tc-grps`) is set with `ref-t` [K], the inverse friction constant for each group is set with `tau-t` [ps]. The parameter `tcoupl` is ignored. The random generator is initialized with `ld-seed`. When used as a thermostat, an appropriate value for `tau-t` is 2 ps, since this results in a friction that is lower than the internal friction of water, while it is high enough to remove excess heat (unless `cut-off` or `reaction-field` electrostatics is used). NOTE: temperature deviations decay twice as fast as with a Berendsen thermostat with the same `tau-t`.

sd1

An efficient leap-frog stochastic dynamics integrator. This integrator is equivalent to `sd`, except that it requires only one Gaussian random number and one constraint step and is therefore significantly faster. Without constraints the accuracy is the same as `sd`. With constraints the accuracy is significantly reduced, so then `sd` will often be preferred.

bd

An Euler integrator for Brownian or position Langevin dynamics, the velocity is the force divided by a friction coefficient (`bd-fric` [amu ps^{-1}]) plus random thermal noise (`ref-t`). When `bd-fric=0`, the friction coefficient for each particle is calculated as $\text{mass}/\text{tau-t}$, as for the integrator `sd`. The random generator is initialized with `ld-seed`.

steep

A steepest descent algorithm for energy minimization. The maximum step size is `emstep` [nm], the tolerance is `emtol` [$\text{kJ mol}^{-1} \text{nm}^{-1}$].

cg

A conjugate gradient algorithm for energy minimization, the tolerance is `emtol` [$\text{kJ mol}^{-1} \text{nm}^{-1}$]. CG is more efficient when a steepest descent step is done every once in a while, this is determined by `nstcgsteep`. For a minimization prior to a normal mode analysis, which requires a very high accuracy, GROMACS should be compiled in double precision.

l-bfgs

A quasi-Newtonian algorithm for energy minimization according to the low-memory Broyden-Fletcher-Goldfarb-Shanno approach. In practice this seems to converge faster than Conjugate Gradients, but due to the correction steps necessary it is not (yet) parallelized.

nm

Normal mode analysis is performed on the structure in the `tpr` file. GROMACS should be compiled in double precision.

tpi

Test particle insertion. The last molecule in the topology is the test particle. A trajectory should be provided with the `-rerun` option of `mdrun`. This trajectory should not contain the molecule to be inserted. Insertions are performed `nsteps` times in each frame at random locations and with random orientations of the molecule. When `nstlist` is larger than one, `nstlist` insertions are performed in a sphere with radius `rtpi` around a the same random location using the same neighborlist (and the same long-range energy when `rvdw` or `rcoulomb` > `rlist`, which is only allowed for single-atom molecules). Since neighborlist construction is expensive, one can perform several extra insertions with the same list almost for free. The random seed is set with `ld-seed`. The temperature for the Boltzmann weighting is set with `ref-t`, this should match the temperature of the simulation of the original trajectory. Dispersion correction is implemented correctly for `tpi`. All relevant quantities are written to the file specified with the `-tpi` option of `mdrun`. The distribution of insertion energies is written to the file specified with the `-tpid` option of `mdrun`. No trajectory or energy file is written. Parallel `tpi` gives identical results to single node `tpi`. For charged molecules, using PME with a fine grid is most accurate and also efficient, since the potential in the system only needs to be calculated once per frame.

tpic

Test particle insertion into a predefined cavity location. The procedure is the same as for `tpi`, except that one coordinate extra is read from the trajectory, which is used as the insertion location. The molecule to be inserted should be centered at 0,0,0. Gromacs does not do this for you, since for different situations a different way of centering might be optimal. Also `rtpi` sets the radius for the sphere around this location. Neighbor searching is done only once per frame, `nstlist` is not used. Parallel `tpic` gives identical results to single node `tpic`.

tinit: (0) [ps]

starting time for your run (only makes sense for integrators `md`, `sd` and `bd`)

dt: (0.001) [ps]

time step for integration (only makes sense for integrators `md`, `sd` and `bd`)

nsteps: (0)

maximum number of steps to integrate or minimize, -1 is no maximum

init-step: (0)

The starting step. The time at a step `i` in a run is calculated as: $t = t_{init} + dt * (init_step + i)$. The free-energy `lambda` is calculated as: $lambda = init_lambda + delta_lambda * (init_step + i)$. Also non-equilibrium MD parameters can depend on the step number. Thus for exact restarts or redoing part of a run it might be necessary to set `init-step` to the step number of the restart frame. `tpbconv` does this automatically.

comm-mode:

Linear

Remove center of mass translation

Angular

Remove center of mass translation and rotation around the center of mass

None

No restriction on the center of mass motion

nstcomm: (100) [steps]

frequency for center of mass motion removal

comm-grps:

group(s) for center of mass motion removal, default is the whole system

7.3.4 Langevin dynamics

bd-fric: (0) [amu ps⁻¹]

Brownian dynamics friction coefficient. When `bd-fric=0`, the friction coefficient for each particle is calculated as `mass/tau-t`.

ld-seed: (1993) [integer]

used to initialize random generator for thermal noise for stochastic and Brownian dynamics. When `ld-seed` is set to -1, the seed is calculated from the process ID. When running BD or SD on multiple processors, each processor uses a seed equal to `ld-seed` plus the processor number.

7.3.5 Energy minimization

emtol: (10.0) [kJ mol⁻¹ nm⁻¹]

the minimization is converged when the maximum force is smaller than this value

emstep: (0.01) [nm]

initial step-size

nstcgsteep: (1000) [steps]

frequency of performing 1 steepest descent step while doing conjugate gradient energy minimization.

nbgscorr: (10)

Number of correction steps to use for L-BFGS minimization. A higher number is (at least theoretically) more accurate, but slower.

7.3.6 Shell Molecular Dynamics

When shells or flexible constraints are present in the system the positions of the shells and the lengths of the flexible constraints are optimized at every time step until either the RMS force on the shells and constraints is less than `emtol`, or a maximum number of iterations (`niter`) has been reached

emtol: (10.0) [kJ mol⁻¹ nm⁻¹]

the minimization is converged when the maximum force is smaller than this value. For shell MD this value should be 1.0 at most, but since the variable is used for energy minimization as well the default is 10.0.

niter: (20)

maximum number of iterations for optimizing the shell positions and the flexible constraints.

fcstep: (0) [ps²]

the step size for optimizing the flexible constraints. Should be chosen as $\mu/(d^2V/dq^2)$ where μ is the reduced mass of two particles in a flexible constraint and d^2V/dq^2 is the second derivative of the potential in the constraint direction. Hopefully this number does not differ too much between the flexible constraints, as the number of iterations and thus the runtime is very sensitive to `fcstep`. Try several values!

7.3.7 Test particle insertion

rtpi: (0.05) [nm]

the test particle insertion radius see integrators `tpi` and `tpic`

7.3.8 Output control

nstxout: (0) [steps]

frequency to write coordinates to output trajectory file, the last coordinates are always written

nstvout: (0) [steps]

frequency to write velocities to output trajectory, the last velocities are always written

nstfout: (0) [steps]

frequency to write forces to output trajectory.

nstlog: (1000) [steps]

frequency to write energies to log file, the last energies are always written

nstcalcenergy: (100)

frequency for calculating the energies, 0 is never. This option is only relevant with dynamics. With a twin-range cut-off setup `nstcalcenergy` should be equal to or a multiple of `nstlist`. This option affects the performance in parallel simulations, because calculating energies requires global communication between all processes which can become a bottleneck at high parallelization.

nstenergy: (1000) [steps]

frequency to write energies to energy file, the last energies are always written, should be a multiple of `nstcalcenergy`. Note that the exact sums and fluctuations over all MD steps modulo `nstcalcenergy` are stored in the energy file, so `g_energy` can report exact energy averages and fluctuations also when `nstenergy`>1

nstxtcout: (0) [steps]

frequency to write coordinates to xtc trajectory

xtc-precision: (1000) [real]

precision to write to xtc trajectory

xtc-grps:

group(s) to write to xtc trajectory, default the whole system is written (if `nstxtcout > 0`)

energygrps:

group(s) to write to energy file

7.3.9 Neighbor searching

cutoff-scheme:

group

Generate a pair list for groups of atoms. These groups correspond to the charge groups in the topology. This was the only cut-off treatment scheme before version 4.6. There is no explicit buffering of the pair list. This enables efficient force calculations, but energy is only conserved when a buffer is explicitly added. For energy conservation, the `Verlet` option provides a more convenient and efficient algorithm.

Verlet

Generate a pair list with buffering. The buffer size is automatically set based on `verlet-buffer-drift`, unless this is set to -1, in which case `rlist` will be used. This option has an explicit, exact cut-off at `rvdw=rcoulomb`. Currently only cut-off, reaction-field, PME electrostatics and plain LJ are supported. Some `mdrun` functionality is not yet supported with the `Verlet` scheme, but `grompp` checks for this. Native GPU acceleration is only supported with `Verlet`. With GPU-accelerated PME, `mdrun` will automatically tune the CPU/GPU load balance by scaling `rcoulomb` and the grid spacing. This can be turned off with `-notunepme`. `Verlet` is somewhat faster than `group` when there is no water, or if `group` would use a pair-list buffer to conserve energy.

nstlist: (10) [steps]

>0

Frequency to update the neighbor list (and the long-range forces, when using twin-range cut-offs). When this is 0, the neighbor list is made only once. With energy minimization the neighborlist will be updated for every energy evaluation when `nstlist > 0`. With non-bonded force calculation on the GPU, a value of 20 or more gives the best performance.

0

The neighbor list is only constructed once and never updated. This is mainly useful for vacuum simulations in which all particles see each other.

-1

Automated update frequency, only supported with `cutoff-scheme=group`. This can only be used with switched, shifted or user potentials where the cut-off can be smaller than `rlist`. One then has a buffer of size `rlist` minus the longest cut-off. The neighbor list is only updated when one or more particles have moved further than half the buffer size from the center of geometry of their charge group as determined at the previous neighbor search. Coordinate scaling due to pressure coupling or the `deform` option is taken into account. This option guarantees that there are no cut-off artifacts, but for larger systems this can come at a high computational cost, since the neighbor list update frequency will be determined by just one or two particles moving slightly beyond the half buffer length (which does not necessarily imply that the neighbor list is invalid), while 99.99% of the particles are fine.

nstcalclr: (-1) [steps]

Controls the period between calculations of long-range forces when using the group cut-off scheme.

1

Calculate the long-range forces every single step. This is useful to have separate neighbor lists with buffers for electrostatics and Van der Waals interactions, and in particular it makes it possible to have the Van der Waals cutoff longer than electrostatics (useful *e.g.* with PME). However, there is no point in having identical long-range cutoffs for both interaction forms and update them every step - then it will be slightly faster to put everything in the short-range list.

>1

Calculate the long-range forces every `nstcalclr` steps and use a multiple-time-step integrator to combine forces. This can now be done more frequently than `nstlist` since the lists are stored, and it might be a good idea *e.g.* for Van der Waals interactions that vary slower than electrostatics.

-1

Calculate long-range forces on steps where neighbor searching is performed. While this is the default value, you might want to consider updating the long-range forces more frequently.

Note that twin-range force evaluation might be enabled automatically by PP-PME load balancing. This is done in order to maintain the chosen Van der Waals interaction radius even if the load balancing is changing the electrostatics cutoff. If the `.mdp` file already specifies twin-range interactions (*e.g.* to evaluate Lennard-Jones interactions with a longer cutoff than the PME electrostatics every 2-3 steps), the load balancing will have also a small effect on Lennard-Jones, since the short-range cutoff (inside which forces are evaluated every step) is changed.

ns-type:

grid

Make a grid in the box and only check atoms in neighboring grid cells when construct-

ing a new neighbor list every `nstlist` steps. In large systems grid search is much faster than simple search.

simple

Check every atom in the box when constructing a new neighbor list every `nstlist` steps.

pbc:**xyz**

Use periodic boundary conditions in all directions.

no

Use no periodic boundary conditions, ignore the box. To simulate without cut-offs, set all cut-offs to 0 and `nstlist=0`. For best performance without cut-offs, use `nstlist=0, ns-type=simple` and particle decomposition instead of domain decomposition.

xy

Use periodic boundary conditions in x and y directions only. This works only with `ns-type=grid` and can be used in combination with `walls`. Without walls or with only one wall the system size is infinite in the z direction. Therefore pressure coupling or Ewald summation methods can not be used. These disadvantages do not apply when two walls are used.

periodic-molecules:**no**

molecules are finite, fast molecular PBC can be used

yes

for systems with molecules that couple to themselves through the periodic boundary conditions, this requires a slower PBC algorithm and molecules are not made whole in the output

verlet-buffer-drift: (0.005) [kJ/mol/ps]

Useful only with `cutoff-scheme=Verlet`. This sets the target energy drift per particle caused by the Verlet buffer, which indirectly sets `rlist`. As both `nstlist` and the Verlet buffer size are fixed (for performance reasons), particle pairs not in the pair list can occasionally get within the cut-off distance during `nstlist-1` nsteps. This generates energy drift. In a constant-temperature ensemble, the drift can be estimated for a given cut-off and `rlist`. The estimate assumes a homogeneous particle distribution, hence the drift might be slightly underestimated for multi-phase systems. For longer pair-list life-time (`nstlist-1`)*`dt` the drift is overestimated, because the interactions between particles are ignored. Combined with cancellation of errors, the actual energy drift is usually one to two orders of magnitude smaller. Note that the generated buffer size takes into account that the GROMACS pair-list setup leads to a reduction in the drift by a factor 10, compared to a simple particle-pair based list. Without dynamics (energy minimization etc.), the buffer is 5% of the cut-off. For dynamics without temperature coupling or to override the buffer size, use `verlet-buffer-drift=-1` and set `rlist` manually.

rlist: (1) [nm]

Cut-off distance for the short-range neighbor list. With `cutoff-scheme=Verlet`, this is by default set by the `verlet-buffer-drift` option and the value of `rlist` is ignored.

rlistlong: (-1) [nm]

Cut-off distance for the long-range neighbor list. This parameter is only relevant for a twin-range cut-off setup with switched potentials. In that case a buffer region is required to account for the size of charge groups. In all other cases this parameter is automatically set to the longest cut-off distance.

7.3.10 Electrostatics**coulombtype:****Cut-off**

Twin range cut-offs with neighborlist cut-off `rlist` and Coulomb cut-off `rcoulomb`, where $rcoulomb \geq rlist$.

Ewald

Classical Ewald sum electrostatics. The real-space cut-off `rcoulomb` should be equal to `rlist`. Use e.g. `rlist=0.9`, `rcoulomb=0.9`. The highest magnitude of wave vectors used in reciprocal space is controlled by `fourierspacing`. The relative accuracy of direct/reciprocal space is controlled by `ewald-rtol`.

NOTE: Ewald scales as $O(N^{3/2})$ and is thus extremely slow for large systems. It is included mainly for reference - in most cases PME will perform much better.

PME

Fast smooth Particle-Mesh Ewald (SPME) electrostatics. Direct space is similar to the Ewald sum, while the reciprocal part is performed with FFTs. Grid dimensions are controlled with `fourierspacing` and the interpolation order with `pme-order`. With a grid spacing of 0.1 nm and cubic interpolation the electrostatic forces have an accuracy of $2\text{-}3 \times 10^{-4}$. Since the error from the vdw-cutoff is larger than this you might try 0.15 nm. When running in parallel the interpolation parallelizes better than the FFT, so try decreasing grid dimensions while increasing interpolation.

P3M-AD

Particle-Particle Particle-Mesh algorithm with analytical derivative for long range electrostatic interactions. The method and code is identical to SPME, except that the influence function is optimized for the grid. This gives a slight increase in accuracy.

Reaction-Field electrostatics

Reaction field with Coulomb cut-off `rcoulomb`, where $rcoulomb \geq rlist$. The dielectric constant beyond the cut-off is `epsilon-rf`. The dielectric constant can be set to infinity by setting `epsilon-rf=0`.

Generalized-Reaction-Field

Generalized reaction field with Coulomb cut-off `rcoulomb`, where $rcoulomb \geq rlist$. The dielectric constant beyond the cut-off is `epsilon-rf`. The ionic strength is computed from the number of charged (*i.e.* with non zero charge) charge groups. The temperature for the GRF potential is set with `ref-t` [K].

Reaction-Field-zero

In GROMACS, normal reaction-field electrostatics with `cutoff-scheme=group` leads to bad energy conservation. `Reaction-Field-zero` solves this by making the potential zero beyond the cut-off. It can only be used with an infinite dielectric constant (`epsilon-rf=0`), because only for that value the force vanishes at the cut-off. `rlist` should be 0.1 to 0.3 nm larger than `rcoulomb` to accommodate for the size of charge groups and diffusion between neighbor list updates. This, and the fact that table lookups are used instead of analytical functions make `Reaction-Field-zero` computationally more expensive than normal reaction-field.

Reaction-Field-nec

The same as `Reaction-Field`, but implemented as in GROMACS versions before 3.3. No reaction-field correction is applied to excluded atom pairs and self pairs. The 1-4 interactions are calculated using a reaction-field. The missing correction due to the excluded pairs that do not have a 1-4 interaction is up to a few percent of the total electrostatic energy and causes a minor difference in the forces and the pressure.

Shift

Analogous to `Shift` for `vdwtype`. You might want to use `Reaction-Field-zero` instead, which has a similar potential shape, but has a physical interpretation and has better energies due to the exclusion correction terms.

Encad-Shift

The Coulomb potential is decreased over the whole range, using the definition from the Encad simulation package.

Switch

Analogous to `Switch` for `vdwtype`. Switching the Coulomb potential can lead to serious artifacts, advice: use `Reaction-Field-zero` instead.

User

`mdrun` will now expect to find a file `table.xvg` with user-defined potential functions for repulsion, dispersion and Coulomb. When pair interactions are present, `mdrun` also expects to find a file `tablep.xvg` for the pair interactions. When the same interactions should be used for non-bonded and pair interactions the user can specify the same file name for both table files. These files should contain 7 columns: the x value, $f(x)$, $-f'(x)$, $g(x)$, $-g'(x)$, $h(x)$, $-h'(x)$, where $f(x)$ is the Coulomb function, $g(x)$ the dispersion function and $h(x)$ the repulsion function. When `vdwtype` is not set to `User` the values for g , $-g'$, h and $-h'$ are ignored. For the non-bonded interactions x values should run from 0 to the largest cut-off distance + `table-extension` and should be uniformly spaced. For the pair interactions the table length in the file will be used. The optimal spacing, which is used for non-user tables, is 0.002 [nm] when you run in single precision or 0.0005 [nm] when you run in double precision. The function value at $x=0$ is not important. More information is in the printed manual.

PME-Switch

A combination of PME and a switch function for the direct-space part (see above). `rcoulomb` is allowed to be smaller than `rlist`. This is mainly useful constant energy simulations (note that using PME with `cutoff-scheme=Verlet` will be more efficient).

PME-User

A combination of PME and user tables (see above). `rcoulomb` is allowed to be smaller than `rlist`. The PME mesh contribution is subtracted from the user table by `mdrun`. Because of this subtraction the user tables should contain about 10 decimal places.

PME-User-Switch

A combination of PME-User and a switching function (see above). The switching function is applied to final particle-particle interaction, *i.e.* both to the user supplied function and the PME Mesh correction part.

coulomb-modifier:**Potential-shift-Verlet**

Selects `Potential-shift` with the Verlet cutoff-scheme, as it is (nearly) free; selects `None` with the group cutoff-scheme.

Potential-shift

Shift the Coulomb potential by a constant such that it is zero at the cut-off. This makes the potential the integral of the force. Note that this does not affect the forces or the sampling.

None

Use an unmodified Coulomb potential. With the group scheme this means no exact cut-off is used, energies and forces are calculated for all pairs in the neighborlist.

rcoulomb-switch: (0) [nm]

where to start switching the Coulomb potential

rcoulomb: (1) [nm]

distance for the Coulomb cut-off

epsilon-r: (1)

The relative dielectric constant. A value of 0 means infinity.

epsilon-rf: (0)

The relative dielectric constant of the reaction field. This is only used with reaction-field electrostatics. A value of 0 means infinity.

7.3.11 VdW

vdwtype:**Cut-off**

Twin range cut-offs with neighbor list cut-off `rlist` and VdW cut-off `rvdw`, where $rvdw \geq rlist$.

Shift

The LJ (not Buckingham) potential is decreased over the whole range and the forces

decay smoothly to zero between `rvdw-switch` and `rvdw`. The neighbor search cut-off `rlist` should be 0.1 to 0.3 nm larger than `rvdw` to accommodate for the size of charge groups and diffusion between neighbor list updates.

Switch

The LJ (not Buckingham) potential is normal out to `rvdw-switch`, after which it is switched off to reach zero at `rvdw`. Both the potential and force functions are continuously smooth, but be aware that all switch functions will give rise to a bulge (increase) in the force (since we are switching the potential). The neighbor search cut-off `rlist` should be 0.1 to 0.3 nm larger than `rvdw` to accommodate for the size of charge groups and diffusion between neighbor list updates.

Encad-Shift

The LJ (not Buckingham) potential is decreased over the whole range, using the definition from the Encad simulation package.

User

See `user` for `coulombtype`. The function value at $x=0$ is not important. When you want to use LJ correction, make sure that `rvdw` corresponds to the cut-off in the user-defined function. When `coulombtype` is not set to `User` the values for `f` and `-f'` are ignored.

vdw-modifier:

Potential-shift-Verlet

Selects `Potential-shift` with the Verlet cutoff-scheme, as it is (nearly) free; selects `None` with the group cutoff-scheme.

Potential-shift

Shift the Van der Waals potential by a constant such that it is zero at the cut-off. This makes the potential the integral of the force. Note that this does not affect the forces or the sampling.

None

Use an unmodified Van der Waals potential. With the group scheme this means no exact cut-off is used, energies and forces are calculated for all pairs in the neighborlist.

rvdw-switch: (0) [nm]

where to start switching the LJ potential

rvdw: (1) [nm]

distance for the LJ or Buckingham cut-off

DispCorr:

no

don't apply any correction

EnerPres

apply long range dispersion corrections for Energy and Pressure

Ener

apply long range dispersion corrections for Energy only

7.3.12 Tables

table-extension: (1) [nm]

Extension of the non-bonded potential lookup tables beyond the largest cut-off distance. The value should be large enough to account for charge group sizes and the diffusion between neighbor-list updates. Without user defined potential the same table length is used for the lookup tables for the 1-4 interactions, which are always tabulated irrespective of the use of tables for the non-bonded interactions.

energygrp-table:

When user tables are used for electrostatics and/or VdW, here one can give pairs of energy groups for which separate user tables should be used. The two energy groups will be appended to the table file name, in order of their definition in `energygrps`, separated by underscores. For example, if `energygrps = Na Cl Sol` and `energygrp-table = Na Na Na Cl`, `mdrun` will read `table_Na_Na.xvg` and `table_Na_Cl.xvg` in addition to the normal `table.xvg` which will be used for all other energy group pairs.

7.3.13 Ewald

fourierspacing: (0.12) [nm]

For ordinary Ewald, the ratio of the box dimensions and the spacing determines a lower bound for the number of wave vectors to use in each (signed) direction. For PME and P3M, that ratio determines a lower bound for the number of Fourier-space grid points that will be used along that axis. In all cases, the number for each direction can be overridden by entering a non-zero value for `fourier_n[xyz]`. For optimizing the relative load of the particle-particle interactions and the mesh part of PME, it is useful to know that the accuracy of the electrostatics remains nearly constant when the Coulomb cut-off and the PME grid spacing are scaled by the same factor.

fourier-nx (0) ; fourier-ny (0) ; fourier-nz: (0)

Highest magnitude of wave vectors in reciprocal space when using Ewald. Grid size when using PME or P3M. These values override `fourierspacing` per direction. The best choice is powers of 2, 3, 5 and 7. Avoid large primes.

pme-order (4)

Interpolation order for PME. 4 equals cubic interpolation. You might try 6/8/10 when running in parallel and simultaneously decrease grid dimension.

ewald-rtol (1e-5)

The relative strength of the Ewald-shifted direct potential at `rcoulomb` is given by `ewald-rtol`. Decreasing this will give a more accurate direct sum, but then you need more wave vectors for the reciprocal sum.

ewald-geometry: (3d)

3d

The Ewald sum is performed in all three dimensions.

3dc

The reciprocal sum is still performed in 3D, but a force and potential correction applied in the z dimension to produce a pseudo-2D summation. If your system has a slab geometry in the x - y plane you can try to increase the z -dimension of the box (a box height of 3 times the slab height is usually ok) and use this option.

epsilon-surface: (0)

This controls the dipole correction to the Ewald summation in 3D. The default value of zero means it is turned off. Turn it on by setting it to the value of the relative permittivity of the imaginary surface around your infinite system. Be careful - you shouldn't use this if you have free mobile charges in your system. This value does not affect the slab 3DC variant of the long range corrections.

optimize-fft:**no**

Don't calculate the optimal FFT plan for the grid at startup.

yes

Calculate the optimal FFT plan for the grid at startup. This saves a few percent for long simulations, but takes a couple of minutes at start.

7.3.14 Temperature coupling**tcoupl:****no**

No temperature coupling.

berendsen

Temperature coupling with a Berendsen-thermostat to a bath with temperature `ref-t` [K], with time constant `tau-t` [ps]. Several groups can be coupled separately, these are specified in the `tc-grps` field separated by spaces.

nose-hoover

Temperature coupling using a Nose-Hoover extended ensemble. The reference temperature and coupling groups are selected as above, but in this case `tau-t` [ps] controls the period of the temperature fluctuations at equilibrium, which is slightly different from a relaxation time. For NVT simulations the conserved energy quantity is written to energy and log file.

v-rescale

Temperature coupling using velocity rescaling with a stochastic term (JCP 126, 014101). This thermostat is similar to Berendsen coupling, with the same scaling using `tau-t`, but the stochastic term ensures that a proper canonical ensemble is generated. The random seed is set with `ld-seed`. This thermostat works correctly even for `tau-t=0`. For NVT simulations the conserved energy quantity is written to the energy and log file.

nsttcouple: (-1)

The frequency for coupling the temperature. The default value of -1 sets `nsttcouple` equal to `nstlist`, unless `nstlist` ≤ 0 , then a value of 10 is used. For velocity Verlet integrators `nsttcouple` is set to 1.

nh-chain-length (10)

the number of chained Nose-Hoover thermostats for velocity Verlet integrators, the leap-frog `md` integrator only supports 1. Data for the NH chain variables is not printed to the `.edr`, but can be using the `GMX_NOSEHOOVER_CHAINS` environment variable

tc-grps:

groups to couple separately to temperature bath

tau-t: [ps]

time constant for coupling (one for each group in `tc-grps`), -1 means no temperature coupling

ref-t: [K]

reference temperature for coupling (one for each group in `tc-grps`)

7.3.15 Pressure coupling

pcoupl:**no**

No pressure coupling. This means a fixed box size.

berendsen

Exponential relaxation pressure coupling with time constant `tau-p` [ps]. The box is scaled every timestep. It has been argued that this does not yield a correct thermodynamic ensemble, but it is the most efficient way to scale a box at the beginning of a run.

Parrinello-Rahman

Extended-ensemble pressure coupling where the box vectors are subject to an equation of motion. The equation of motion for the atoms is coupled to this. No instantaneous scaling takes place. As for Nose-Hoover temperature coupling the time constant `tau-p` [ps] is the period of pressure fluctuations at equilibrium. This is probably a better method when you want to apply pressure scaling during data collection, but beware that you can get very large oscillations if you are starting from a different pressure. For simulations where the exact fluctuation of the NPT ensemble are important, or if the pressure coupling time is very short it may not be appropriate, as the previous time step pressure is used in some steps of the GROMACS implementation for the current time step pressure.

MTTK

Martyna-Tuckerman-Tobias-Klein implementation, only useable with `md-vv` or `md-vv-avek`, very similar to Parrinello-Rahman. As for Nose-Hoover temperature coupling the time constant `tau-p` [ps] is the period of pressure fluctuations at equilibrium. This is probably a

better method when you want to apply pressure scaling during data collection, but beware that you can get very large oscillations if you are starting from a different pressure. Currently only supports isotropic scaling.

pcoupltype:

isotropic

Isotropic pressure coupling with time constant `tau-p` [ps]. The compressibility and reference pressure are set with `compressibility` [bar^{-1}] and `ref-p` [bar], one value is needed.

semiisotropic

Pressure coupling which is isotropic in the x and y direction, but different in the z direction. This can be useful for membrane simulations. 2 values are needed for x/y and z directions respectively.

anisotropic

Idem, but 6 values are needed for xx , yy , zz , xy/yx , xz/zx and yz/zy components, respectively. When the off-diagonal compressibilities are set to zero, a rectangular box will stay rectangular. Beware that anisotropic scaling can lead to extreme deformation of the simulation box.

surface-tension

Surface tension coupling for surfaces parallel to the xy -plane. Uses normal pressure coupling for the z -direction, while the surface tension is coupled to the x/y dimensions of the box. The first `ref-p` value is the reference surface tension times the number of surfaces [bar nm], the second value is the reference z -pressure [bar]. The two `compressibility` [bar^{-1}] values are the compressibility in the x/y and z direction respectively. The value for the z -compressibility should be reasonably accurate since it influences the convergence of the surface-tension, it can also be set to zero to have a box with constant height.

nstpcouple: (-1)

The frequency for coupling the pressure. The default value of -1 sets `nstpcouple` equal to `nstlist`, unless `nstlist` ≤ 0 , then a value of 10 is used. For velocity Verlet integrators `nstpcouple` is set to 1.

tau-p: (1) [ps]

time constant for coupling

compressibility: [bar^{-1}]

compressibility (NOTE: this is now really in bar^{-1}) For water at 1 atm and 300 K the compressibility is $4.5e-5$ [bar^{-1}].

ref-p: [bar]

reference pressure for coupling

refcoord-scaling:

no

The reference coordinates for position restraints are not modified. Note that with this option the virial and pressure will depend on the absolute positions of the reference coordinates.

all

The reference coordinates are scaled with the scaling matrix of the pressure coupling.

com

Scale the center of mass of the reference coordinates with the scaling matrix of the pressure coupling. The vectors of each reference coordinate to the center of mass are not scaled. Only one COM is used, even when there are multiple molecules with position restraints. For calculating the COM of the reference coordinates in the starting configuration, periodic boundary conditions are not taken into account.

7.3.16 Simulated annealing

Simulated annealing is controlled separately for each temperature group in GROMACS. The reference temperature is a piecewise linear function, but you can use an arbitrary number of points for each group, and choose either a single sequence or a periodic behaviour for each group. The actual annealing is performed by dynamically changing the reference temperature used in the thermostat algorithm selected, so remember that the system will usually not instantaneously reach the reference temperature!

annealing:

Type of annealing for each temperature group

no

No simulated annealing - just couple to reference temperature value.

single

A single sequence of annealing points. If your simulation is longer than the time of the last point, the temperature will be coupled to this constant value after the annealing sequence has reached the last time point.

periodic

The annealing will start over at the first reference point once the last reference time is reached. This is repeated until the simulation ends.

annealing-npoints:

A list with the number of annealing reference/control points used for each temperature group. Use 0 for groups that are not annealed. The number of entries should equal the number of temperature groups.

annealing-time:

List of times at the annealing reference/control points for each group. If you are using periodic annealing, the times will be used modulo the last value, *i.e.* if the values are 0, 5, 10, and 15, the coupling will restart at the 0ps value after 15ps, 30ps, 45ps, etc. The number of entries should equal the sum of the numbers given in `annealing-npoints`.

annealing-temp:

List of temperatures at the annealing reference/control points for each group. The number of entries should equal the sum of the numbers given in `annealing-npoints`.

Confused? OK, let's use an example. Assume you have two temperature groups, set the group selections to `annealing = single periodic`, the number of points of each group to `annealing-npoints = 3 4`, the times to `annealing-time = 0 3 6 0 2 4 6` and finally temperatures to `annealing-temp = 298 280 270 298 320 320 298`. The first group will be coupled to 298K at 0ps, but the reference temperature will drop linearly to reach 280K at 3ps, and then linearly between 280K and 270K from 3ps to 6ps. After this it stays constant, at 270K. The second group is coupled to 298K at 0ps, it increases linearly to 320K at 2ps, where it stays constant until 4ps. Between 4ps and 6ps it decreases to 298K, and then it starts over with the same pattern again, *i.e.* rising linearly from 298K to 320K between 6ps and 8ps. Check the summary printed by `grompp` if you are unsure!

7.3.17 Velocity generation**gen-vel:****no**

Do not generate velocities. The velocities are set to zero when there are no velocities in the input structure file.

yes

Generate velocities in `grompp` according to a Maxwell distribution at temperature `gen-temp` [K], with random seed `gen-seed`. This is only meaningful with integrator `md`.

gen-temp: (300) [K]

temperature for Maxwell distribution

gen-seed: (173529) [integer]

used to initialize random generator for random velocities, when `gen-seed` is set to -1, the seed is calculated from the process ID number.

7.3.18 Bonds**constraints:****none**

No constraints except for those defined explicitly in the topology, *i.e.* bonds are represented by a harmonic (or other) potential or a Morse potential (depending on the setting of `morse`) and angles by a harmonic (or other) potential.

h-bonds

Convert the bonds with H-atoms to constraints.

all-bonds

Convert all bonds to constraints.

h-angles

Convert all bonds and additionally the angles that involve H-atoms to bond-constraints.

all-angles

Convert all bonds and angles to bond-constraints.

constraint-algorithm:**LINCS**

LINear Constraint Solver. With domain decomposition the parallel version P-LINCS is used. The accuracy is set with `lincs-order`, which sets the number of matrices in the expansion for the matrix inversion. After the matrix inversion correction the algorithm does an iterative correction to compensate for lengthening due to rotation. The number of such iterations can be controlled with `lincs-iter`. The root mean square relative constraint deviation is printed to the log file every `nstlog` steps. If a bond rotates more than `lincs-warnangle` [degrees] in one step, a warning will be printed both to the log file and to `stderr`. LINCS should not be used with coupled angle constraints.

SHAKE

SHAKE is slightly slower and less stable than LINCS, but does work with angle constraints. The relative tolerance is set with `shake-tol`, 0.0001 is a good value for “normal” MD. SHAKE does not support constraints between atoms on different nodes, thus it can not be used with domain decomposition when inter charge-group constraints are present. SHAKE can not be used with energy minimization.

continuation:

This option was formerly known as `unconstrained-start`.

no

apply constraints to the start configuration and reset shells

yes

do not apply constraints to the start configuration and do not reset shells, useful for exact continuation and reruns

shake-tol: (0.0001)

relative tolerance for SHAKE

lincs-order: (4)

Highest order in the expansion of the constraint coupling matrix. When constraints form triangles, an additional expansion of the same order is applied on top of the normal expansion only for the couplings within such triangles. For “normal” MD simulations an order of 4 usually suffices, 6 is needed for large time-steps with virtual sites or BD. For accurate energy minimization an order of 8 or more might be required. With domain decomposition, the cell size is limited by the distance spanned by `lincs-order+1` constraints. When one wants to scale further than this limit, one can decrease `lincs-order` and increase `lincs-iter`, since the accuracy does not deteriorate when $(1+lincs-iter)*lincs-order$ remains constant.

lincs-iter: (1)

Number of iterations to correct for rotational lengthening in LINCS. For normal runs a single step is sufficient, but for NVE runs where you want to conserve energy accurately or for accurate energy minimization you might want to increase it to 2.

lincs-warnangle: (30) [degrees]

maximum angle that a bond can rotate before LINCS will complain

morse:**no**

bonds are represented by a harmonic potential

yes

bonds are represented by a Morse potential

7.3.19 Energy group exclusions

energygrp-excl:

Pairs of energy groups for which all non-bonded interactions are excluded. An example: if you have two energy groups `Protein` and `SOL`, specifying

```
energygrp-excl = Protein Protein SOL SOL
```

would give only the non-bonded interactions between the protein and the solvent. This is especially useful for speeding up energy calculations with `mdrun -rerun` and for excluding interactions within frozen groups.

7.3.20 Walls

nwall: 0

When set to 1 there is a wall at $z=0$, when set to 2 there is also a wall at $z=z\text{-box}$. Walls can only be used with `pbcs=xy`. When set to 2 pressure coupling and Ewald summation can be used (it is usually best to use semiisotropic pressure coupling with the x/y compressibility set to 0, as otherwise the surface area will change). Walls interact with the rest of the system through an optional `wall-atomtype`. Energy groups `wall0` and `wall1` (for `nwall=2`) are added automatically to monitor the interaction of energy groups with each wall. The center of mass motion removal will be turned off in the z -direction.

wall-atomtype:

the atom type name in the force field for each wall. By (for example) defining a special wall atom type in the topology with its own combination rules, this allows for independent tuning of the interaction of each atomtype with the walls.

wall-type:**9-3**

LJ integrated over the volume behind the wall: 9-3 potential

10-4

LJ integrated over the wall surface: 10-4 potential

12-6

direct LJ potential with the z distance from the wall

table

user defined potentials indexed with the z distance from the wall, the tables are read analogously to the `energygrp-table` option, where the first name is for a “normal” energy group and the second name is `wall0` or `wall1`, only the dispersion and repulsion columns are used

wall-r-linpot: -1 (nm)

Below this distance from the wall the potential is continued linearly and thus the force is constant. Setting this option to a positive value is especially useful for equilibration when some atoms are beyond a wall. When the value is ≤ 0 (< 0 for `wall-type=table`), a fatal error is generated when atoms are beyond a wall.

wall-density: [nm⁻³/nm⁻²]

the number density of the atoms for each wall for wall types 9-3 and 10-4

wall-ewald-zfac: 3

The scaling factor for the third box vector for Ewald summation only, the minimum is 2. Ewald summation can only be used with `nwall=2`, where one should use `ewald-geometry=3dc`. The empty layer in the box serves to decrease the unphysical Coulomb interaction between periodic images.

7.3.21 COM pulling**pull:****no**

No center of mass pulling. All the following pull options will be ignored (and if present in the `.mdp` file, they unfortunately generate warnings)

umbrella

Center of mass pulling using an umbrella potential between the reference group and one or more groups.

constraint

Center of mass pulling using a constraint between the reference group and one or more groups. The setup is identical to the option `umbrella`, except for the fact that a rigid constraint is applied instead of a harmonic potential.

constant-force

Center of mass pulling using a linear potential and therefore a constant force. For this option there is no reference position and therefore the parameters `pull-init` and `pull-rate` are not used.

pull-geometry:

distance

Pull along the vector connecting the two groups. Components can be selected with `pull-dim`.

direction

Pull in the direction of `pull-vec`.

direction-periodic

As `direction`, but allows the distance to be larger than half the box size. With this geometry the box should not be dynamic (*e.g.* no pressure scaling) in the pull dimensions and the pull force is not added to virial.

cylinder

Designed for pulling with respect to a layer where the reference COM is given by a local cylindrical part of the reference group. The pulling is in the direction of `pull-vec`. From the reference group a cylinder is selected around the axis going through the pull group with direction `pull-vec` using two radii. The radius `pull-r1` gives the radius within which all the relative weights are one, between `pull-r1` and `pull-r0` the weights are switched to zero. Mass weighting is also used. Note that the radii should be smaller than half the box size. For tilted cylinders they should be even smaller than half the box size since the distance of an atom in the reference group from the COM of the pull group has both a radial and an axial component.

position

Pull to the position of the reference group plus `pull-init + time*pull-rate*pull-vec`.

pull-dim: (Y Y Y)

the distance components to be used with geometry `distance` and `position`, and also sets which components are printed to the output files

pull-r1: (1) [nm]

the inner radius of the cylinder for geometry `cylinder`

pull-r0: (1) [nm]

the outer radius of the cylinder for geometry `cylinder`

pull-constr-tol: (1e-6)

the relative constraint tolerance for constraint pulling

pull-start:**no**

do not modify `pull-init`

yes

add the COM distance of the starting conformation to `pull-init`

pull-nstxout: (10)

frequency for writing out the COMs of all the pull group

pull-nstfout: (1)

frequency for writing out the force of all the pulled group

pull-ngroups: (1)

The number of pull groups, not including the reference group. If there is only one group, there is no difference in treatment of the reference and pulled group (except with the cylinder geometry). Below only the pull options for the reference group (ending on 0) and the first group (ending on 1) are given, further groups work analogously, but with the number 1 replaced by the group number.

pull-group0:

The name of the reference group. When this is empty an absolute reference of (0,0,0) is used. With an absolute reference the system is no longer translation invariant and one should think about what to do with the center of mass motion.

pull-weights0:

see `pull-weights1`

pull-pbcatom0: (0)

see `pull-pbcatom1`

pull-group1:

The name of the pull group.

pull-weights1:

Optional relative weights which are multiplied with the masses of the atoms to give the total weight for the COM. The number should be 0, meaning all 1, or the number of atoms in the pull group.

pull-pbcatom1: (0)

The reference atom for the treatment of periodic boundary conditions inside the group (this has no effect on the treatment of the pbc between groups). This option is only important when the diameter of the pull group is larger than half the shortest box vector. For determining the COM, all atoms in the group are put at their periodic image which is closest to `pull-pbcatom1`. A value of 0 means that the middle atom (number wise) is used. This parameter is not used with geometry `cylinder`. A value of -1 turns on cosine weighting, which is useful for a group of molecules in a periodic system, *e.g.* a water slab (see Engin et al. J. Chem. Phys. B 2010).

pull-vec1: (0.0 0.0 0.0)

The pull direction. `grompp` normalizes the vector.

pull-init1: (0.0) / (0.0 0.0 0.0) [nm]

The reference distance at $t=0$. This is a single value, except for geometry `position` which uses a vector.

pull-rate1: (0) [nm/ps]

The rate of change of the reference position.

pull-k1: (0) [kJ mol⁻¹ nm⁻² / [kJ mol⁻¹ nm⁻¹]]

The force constant. For umbrella pulling this is the harmonic force constant in [kJ mol⁻¹ nm⁻²]. For constant force pulling this is the force constant of the linear potential, and thus minus (!) the constant force in [kJ mol⁻¹ nm⁻¹].

pull-kB1: (pull-k1) [kJ mol⁻¹ nm⁻² / [kJ mol⁻¹ nm⁻¹]]

As pull-k1, but for state B. This is only used when free-energy is turned on. The force constant is then $(1 - \lambda) \cdot \text{pull-k1} + \lambda \cdot \text{pull-kB1}$.

7.3.22 NMR refinement

disre:

no

ignore distance restraint information in topology file

simple

simple (per-molecule) distance restraints.

ensemble

distance restraints over an ensemble of molecules in one simulation box. Normally, one would perform ensemble averaging over multiple subsystems, each in a separate box, using `mdrun -multi; apply topol0.tpr, topol1.tpr, ...` with different coordinates and/or velocities. The environment variable `GMX_DISRE_ENSEMBLE_SIZE` sets the number of systems within each ensemble (usually equal to the `mdrun -multi` value).

disre-weighting:

equal (default)

divide the restraint force equally over all atom pairs in the restraint

conservative

the forces are the derivative of the restraint potential, this results in an r^{-7} weighting of the atom pairs. The forces are conservative when `disre-tau` is zero.

disre-mixed:

no

the violation used in the calculation of the restraint force is the time-averaged violation

yes

the violation used in the calculation of the restraint force is the square root of the product of the time-averaged violation and the instantaneous violation

disre-fc: (1000) [kJ mol⁻¹ nm⁻²]

force constant for distance restraints, which is multiplied by a (possibly) different factor for each restraint given in the `fac` column of the interaction in the topology file.

disre-tau: (0) [ps]

time constant for distance restraints running average. A value of zero turns off time averaging.

nstdisreout: (100) [steps]

period between steps when the running time-averaged and instantaneous distances of all atom pairs involved in restraints are written to the energy file (can make the energy file very large)

orire:**no**

ignore orientation restraint information in topology file

yesuse orientation restraints, ensemble averaging can be performed with `mdrun -multi`**orire-fc: (0) [kJ mol]**

force constant for orientation restraints, which is multiplied by a (possibly) different weight factor for each restraint, can be set to zero to obtain the orientations from a free simulation

orire-tau: (0) [ps]

time constant for orientation restraints running average. A value of zero turns off time averaging.

orire-fitgrp:fit group for orientation restraining. This group of atoms is used to determine the rotation R of the system with respect to the reference orientation. The reference orientation is the starting conformation of the first subsystem. For a protein, backbone is a reasonable choice**nstorireout: (100) [steps]**

period between steps when the running time-averaged and instantaneous orientations for all restraints, and the molecular order tensor are written to the energy file (can make the energy file very large)

7.3.23 Free energy calculations**free-energy:****no**

Only use topology A.

yesInterpolate between topology A ($\lambda=0$) to topology B ($\lambda=1$) and write the derivative of the Hamiltonian with respect to λ (as specified with `dhdl-derivatives`), or the Hamiltonian differences with respect to other λ values (as specified with `foreign-lambda`) to the energy file and/or to `dhdl.xvg`, where they can be processed by, for example `g_bar`. The potentials, bond-lengths and angles are interpolated linearly as described in the manual. When `sc-alpha` is larger than zero, soft-core potentials are used for the LJ and Coulomb interactions.**expanded**

Turns on expanded ensemble simulation, where the alchemical state becomes a dynamic variable, allowing jumping between different Hamiltonians. See the expanded ensemble options for controlling how expanded ensemble simulations are performed. The different Hamiltonians used in expanded ensemble simulations are defined by the other free energy options.

init-lambda: (-1)

starting value for lambda (float). Generally, this should only be used with slow growth (*i.e.* nonzero delta-lambda). In other cases, `init-lambda-state` should be specified instead. Must be greater than or equal to 0.

delta-lambda: (0)

increment per time step for lambda

init-lambda-state: (-1)

starting value for the lambda state (integer). Specifies which column of the lambda vector (`coul-lambdas`, `vdw-lambdas`, `bonded-lambdas`, `restraint-lambdas`, `mass-lambdas`, `temperature-lambdas`, `fep-lambdas`) should be used. This is a zero-based index: `init-lambda-state 0` means the first column, and so on.

fep-lambdas: ()

Zero, one or more lambda values for which Delta H values will be determined and written to `dhdl.xvg` every `nstdhdl` steps. Values must be between 0 and 1. Free energy differences between different lambda values can then be determined with `g_bar`. `fep-lambdas` is different from the other `-lambdas` keywords because all components of the lambda vector that are not specified will use `fep-lambdas` (including `restraint-lambdas` and therefore the pull code restraints).

coul-lambdas: ()

Zero, one or more lambda values for which Delta H values will be determined and written to `dhdl.xvg` every `nstdhdl` steps. Values must be between 0 and 1. Only the electrostatic interactions are controlled with this component of the lambda vector (and only if the `lambda=0` and `lambda=1` states have differing electrostatic interactions).

vdw-lambdas: ()

Zero, one or more lambda values for which Delta H values will be determined and written to `dhdl.xvg` every `nstdhdl` steps. Values must be between 0 and 1. Only the van der Waals interactions are controlled with this component of the lambda vector.

bonded-lambdas: ()

Zero, one or more lambda values for which Delta H values will be determined and written to `dhdl.xvg` every `nstdhdl` steps. Values must be between 0 and 1. Only the bonded interactions are controlled with this component of the lambda vector.

restraint-lambdas: ()

Zero, one or more lambda values for which Delta H values will be determined and written to `dhdl.xvg` every `nstdhdl` steps. Values must be between 0 and 1. Only the restraint interactions: dihedral restraints, and the pull code restraints are controlled with this component of the lambda vector.

mass-lambdas: ()

Zero, one or more lambda values for which Delta H values will be determined and written to `dhdl.xvg` every `nstdhdl` steps. Values must be between 0 and 1. Only the particle masses are controlled with this component of the lambda vector.

temperature-lambdas: ()

Zero, one or more lambda values for which Delta H values will be determined and written to `dhdl.xvg` every `nstdhdl` steps. Values must be between 0 and 1. Only the temperatures controlled with this component of the lambda vector. Note that these lambdas should not be used for replica exchange, only for simulated tempering.

calc-lambda-neighbors (1)

Controls the number of lambda values for which Delta H values will be calculated and written out, if `init-lambda-state` has been set. A positive value will limit the number of lambda points calculated to only the `n`th neighbors of `init-lambda-state`: for example, if `init-lambda-state` is 5 and this parameter has a value of 2, energies for lambda points 3-7 will be calculated and written out. A value of -1 means all lambda points will be written out. For normal BAR such as with `g_bar`, a value of 1 is sufficient, while for MBAR -1 should be used.

sc-alpha: (0)

the soft-core alpha parameter, a value of 0 results in linear interpolation of the LJ and Coulomb interactions

sc-r-power: (6)

the power of the radial term in the soft-core equation. Possible values are 6 and 48. 6 is more standard, and is the default. When 48 is used, then `sc-alpha` should generally be much lower (between 0.001 and 0.003).

sc-coul: (no)

Whether to apply the soft core free energy interactions to the Coulombic interaction. Default is no, as it is generally more efficient to turn off the Coulombic interactions linearly before turning off electrostatic interactions.

sc-power: (0)

the power for lambda in the soft-core function, only the values 1 and 2 are supported

sc-sigma: (0.3) [nm]

the soft-core sigma for particles which have a C6 or C12 parameter equal to zero or a sigma smaller than `sc-sigma`

couple-moltype:

Here one can supply a molecule type (as defined in the topology) for calculating solvation or coupling free energies. There is a special option `system` that couples all molecule types in the system. This can be useful for equilibrating a system starting from (nearly) random coordinates. `free-energy` has to be turned on. The Van der Waals interactions and/or charges in this molecule type can be turned on or off between `lambda=0` and `lambda=1`, depending on the settings of `couple-lambda0` and `couple-lambda1`. If you want to decouple one of several copies of a molecule, you need to copy and rename the molecule definition in the topology.

couple-lambda0:

vdw-q

all interactions are on at lambda=0

vdw

the charges are zero (no Coulomb interactions) at lambda=0

q

the Van der Waals interactions are turned at lambda=0; soft-core interactions will be required to avoid singularities

none

the Van der Waals interactions are turned off and the charges are zero at lambda=0; soft-core interactions will be required to avoid singularities.

couple-lambda1:

analogous to `couple-lambda1`, but for lambda=1

couple-intramol:**no**

All intra-molecular non-bonded interactions for moleculetype `couple-moltype` are replaced by exclusions and explicit pair interactions. In this manner the decoupled state of the molecule corresponds to the proper vacuum state without periodicity effects.

yes

The intra-molecular Van der Waals and Coulomb interactions are also turned on/off. This can be useful for partitioning free-energies of relatively large molecules, where the intra-molecular non-bonded interactions might lead to kinetically trapped vacuum conformations. The 1-4 pair interactions are not turned off.

nstdhdl: (100)

the frequency for writing dH/dlambda and possibly Delta H to `dhdl.xvg`, 0 means no output, should be a multiple of `nstcalcenergy`.

dhdl-derivatives: (yes)

If yes (the default), the derivatives of the Hamiltonian with respect to lambda at each `nstdhdl` step are written out. These values are needed for interpolation of linear energy differences with `g_bar` (although the same can also be achieved with the right `foreign lambda` setting, that may not be as flexible), or with thermodynamic integration

dhdl-print-energy: (no)

Include the total energy in the `dhdl` file. This information is needed for later analysis if the states of interest in the free energy calculation are at different temperatures. If all are at the same temperature, this information is not needed.

separate-dhdl-file: (yes)**yes**

the free energy values that are calculated (as specified with the `foreign-lambda` and `dhdl-derivatives` settings) are written out to a separate file, with the default name `dhdl.xvg`. This file can be used directly with `g_bar`.

no

The free energy values are written out to the energy output file (`ener.edr`, in accumulated blocks at every `nstenergy` steps), where they can be extracted with `g_energy` or used directly with `g_bar`.

dh-hist-size: (0)

If nonzero, specifies the size of the histogram into which the Delta H values (specified with `foreign-lambda`) and the derivative $dH/d\lambda$ values are binned, and written to `ener.edr`. This can be used to save disk space while calculating free energy differences. One histogram gets written for each `foreign lambda` and two for the $dH/d\lambda$, at every `nstenergy` step. Be aware that incorrect histogram settings (too small size or too wide bins) can introduce errors. Do not use histograms unless you're certain you need it.

dh-hist-spacing (0.1)

Specifies the bin width of the histograms, in energy units. Used in conjunction with `dh-hist-size`. This size limits the accuracy with which free energies can be calculated. Do not use histograms unless you're certain you need it.

7.3.24 Expanded Ensemble calculations

nstexpanded

The number of integration steps between attempted moves changing the system Hamiltonian in expanded ensemble simulations. Must be a multiple of `nstcalcenergy`, but can be greater or less than `nstdhdl`.

lmc-stats:

no

No Monte Carlo in state space is performed.

metropolis-transition

Uses the Metropolis weights to update the expanded ensemble weight of each state. $\text{Min}1, \exp(-(\beta_{\text{new}} u_{\text{new}} - \beta_{\text{old}} u_{\text{old}}))$

barker-transition

Uses the Barker transition criteria to update the expanded ensemble weight of each state i , defined by $\exp(-\beta_{\text{new}} u_{\text{new}}) / [\exp(-\beta_{\text{new}} u_{\text{new}}) + \exp(-\beta_{\text{old}} u_{\text{old}})]$

wang-landau

Uses the Wang-Landau algorithm (in state space, not energy space) to update the expanded ensemble weights.

min-variance

Uses the minimum variance updating method of Escobedo et al. to update the expanded ensemble weights. Weights will not be the free energies, but will rather emphasize states that need more sampling to give even uncertainty.

lmc-mc-move:

no

No Monte Carlo in state space is performed.

metropolis-transition

Randomly chooses a new state up or down, then uses the Metropolis criteria to decide whether to accept or reject: $\text{Min}(1, \exp(-(\beta_{\text{new}} u_{\text{new}} - \beta_{\text{old}} u_{\text{old}})))$

barker-transition

Randomly chooses a new state up or down, then uses the Barker transition criteria to decide whether to accept or reject: $\exp(-\beta_{\text{new}} u_{\text{new}}) / [\exp(-\beta_{\text{new}} u_{\text{new}}) + \exp(-\beta_{\text{old}} u_{\text{old}})]$

gibbs

Uses the conditional weights of the state given the coordinate $(\exp(-\beta_i u_i) / \sum_k \exp(\beta_i u_i))$ to decide which state to move to.

metropolized-gibbs

Uses the conditional weights of the state given the coordinate $(\exp(-\beta_i u_i) / \sum_k \exp(\beta_i u_i))$ to decide which state to move to, EXCLUDING the current state, then uses a rejection step to ensure detailed balance. Always more efficient than Gibbs, though only marginally so in many situations, such as when only the nearest neighbors have decent phase space overlap.

lmc-seed:

random seed to use for Monte Carlo moves in state space. If not specified, `ld-seed` is used instead.

mc-temperature:

Temperature used for acceptance/rejection for Monte Carlo moves. If not specified, the temperature of the simulation specified in the first group of `ref_t` is used.

wl-ratio: (0.8)

The cutoff for the histogram of state occupancies to be reset, and the free energy incrementor to be reset as $\delta_i \delta_j \text{wl-scale}$. If we define the $N_{\text{ratio}} = (\text{number of samples at each histogram}) / (\text{average number of samples at each histogram})$, `wl-ratio` of 0.8 means that means that the histogram is only considered flat if all $N_{\text{ratio}} > 0.8$ AND simultaneously all $1/N_{\text{ratio}} > 0.8$.

wl-scale: (0.8)

Each time the histogram is considered flat, then the current value of the Wang-Landau incrementor for the free energies is multiplied by `wl-scale`. Value must be between 0 and 1.

init-wl-delta: (1.0)

The initial value of the Wang-Landau incrementor in kT. Some value near 1 kT is usually most efficient, though sometimes a value of 2-3 in units of kT works better if the free energy differences are large.

wl-oneovert: (no)

Set Wang-Landau incrementor to scale with $1/(\text{simulation time})$ in the large sample limit. There is significant evidence that the standard Wang-Landau algorithms in state space presented here result in free energies getting 'burned in' to incorrect values that depend on the

initial state. when `wl-oneovert` is true, then when the incrementor becomes less than $1/N$, where N is the number of samples collected (and thus proportional to the data collection time, hence 1 over t), then the Wang-Lambda incrementor is set to $1/N$, decreasing every step. Once this occurs, `wl-ratio` is ignored, but the weights will still stop updating when the equilibration criteria set in `lmc-weights-equil` is achieved.

lmc-repeats: (1)

Controls the number of times that each Monte Carlo swap type is performed each iteration. In the limit of large numbers of Monte Carlo repeats, then all methods converge to Gibbs sampling. The value will generally not need to be different from 1.

lmc-gibbsdeltat: (-1)

Limit Gibbs sampling to selected numbers of neighboring states. For Gibbs sampling, it is sometimes inefficient to perform Gibbs sampling over all of the states that are defined. A positive value of `lmc-gibbsdeltat` means that only states plus or minus `lmc-gibbsdeltat` are considered in exchanges up and down. A value of -1 means that all states are considered. For less than 100 states, it is probably not that expensive to include all states.

lmc-forced-nstart: (0)

Force initial state space sampling to generate weights. In order to come up with reasonable initial weights, this setting allows the simulation to drive from the initial to the final lambda state, with `lmc-forced-nstart` steps at each state before moving on to the next lambda state. If `lmc-forced-nstart` is sufficiently long (thousands of steps, perhaps), then the weights will be close to correct. However, in most cases, it is probably better to simply run the standard weight equilibration algorithms.

nst-transition-matrix: (-1)

Frequency of outputting the expanded ensemble transition matrix. A negative number means it will only be printed at the end of the simulation.

symmetrized-transition-matrix: (no)

Whether to symmetrize the empirical transition matrix. In the infinite limit the matrix will be symmetric, but will diverge with statistical noise for short timescales. Forced symmetrization, by using the matrix $T_{\text{sym}} = 1/2 (T + \text{transpose}(T))$, removes problems like the existence of (small magnitude) negative eigenvalues.

mininum-var-min: (100)

The min-variance strategy (option of `lmc-stats` is only valid for larger number of samples, and can get stuck if too few samples are used at each state. `mininum-var-min` is the minimum number of samples that each state that are allowed before the min-variance strategy is activated if selected.

init-lambda-weights:

The initial weights (free energies) used for the expanded ensemble states. Default is a vector of zero weights. format is similar to the lambda vector settings in `fep-lambdas`, except the weights can be any floating point number. Units are kT . Its length must match the lambda vector lengths.

lmc-weights-equil: (no)

- no**
Expanded ensemble weights continue to be updated throughout the simulation.
- yes**
The input expanded ensemble weights are treated as equilibrated, and are not updated throughout the simulation.
- wl-delta**
Expanded ensemble weight updating is stopped when the Wang-Landau incrementor falls below the value specified by `weight-equil-wl-delta`.
- number-all-lambda**
Expanded ensemble weight updating is stopped when the number of samples at all of the lambda states is greater than the value specified by `weight-equil-number-all-lambda`.
- number-steps**
Expanded ensemble weight updating is stopped when the number of steps is greater than the level specified by `weight-equil-number-steps`.
- number-samples**
Expanded ensemble weight updating is stopped when the number of total samples across all lambda states is greater than the level specified by `weight-equil-number-samples`.
- count-ratio**
Expanded ensemble weight updating is stopped when the ratio of samples at the least sampled lambda state and most sampled lambda state greater than the value specified by `weight-equil-count-ratio`.
- simulated-tempering: (no)**
Turn simulated tempering on or off. Simulated tempering is implemented as expanded ensemble sampling with different temperatures instead of different Hamiltonians.
- sim-temp-low: (300)**
Low temperature for simulated tempering.
- sim-temp-high: (300)**
High temperature for simulated tempering.
- simulated-tempering-scaling: (linear)**
Controls the way that the temperatures at intermediate lambdas are calculated from the `temperature-lambda` part of the lambda vector.
- linear**
Linearly interpolates the temperatures using the values of `temperature-lambda`, *i.e.* if `sim-temp-low=300`, `sim-temp-high=400`, then `lambda=0.5` correspond to a temperature of 350. A nonlinear set of temperatures can always be implemented with uneven spacing in lambda.
- geometric**
Interpolates temperatures geometrically between `sim-temp-low` and `sim-temp-high`. The *i*:th state has temperature `sim-temp-low * (sim-temp-high/sim-temp-low)` raised to the power of `(i/(ntemps-1))`. This should give roughly equal exchange for constant heat capacity, though of course things simulations that involve protein folding have very high heat capacity peaks.

exponential

Interpolates temperatures exponentially between `sim-temp-low` and `sim-temp-high`.

The *i*th state has temperature `sim-temp-low + (sim-temp-high-sim-temp-low)*((exp(temp-i)/exp(1.0)-1))`.

7.3.25 Non-equilibrium MD**acc-grps :**

groups for constant acceleration (e.g.: `Protein Sol`) all atoms in groups `Protein` and `Sol` will experience constant acceleration as specified in the `accelerate` line

accelerate: (0) [nm ps⁻²]

acceleration for `acc-grps`; x, y and z for each group (e.g. `0.1 0.0 0.0 -0.1 0.0 0.0` means that first group has constant acceleration of 0.1 nm ps^{-2} in X direction, second group the opposite).

freezegrps :

Groups that are to be frozen (i.e. their X, Y, and/or Z position will not be updated; e.g. `Lipid SOL`). `freezedim` specifies for which dimension the freezing applies. To avoid spurious contributions to the virial and pressure due to large forces between completely frozen atoms you need to use energy group exclusions, this also saves computing time. Note that coordinates of frozen atoms are not scaled by pressure-coupling algorithms.

freezedim:

dimensions for which groups in `freezegrps` should be frozen, specify Y or N for X, Y and Z and for each group (e.g. `Y Y N N N N` means that particles in the first group can move only in Z direction. The particles in the second group can move in any direction).

cos-acceleration: (0) [nm ps⁻²]

the amplitude of the acceleration profile for calculating the viscosity. The acceleration is in the X-direction and the magnitude is `cos-acceleration cos(2 pi z/boxheight)`. Two terms are added to the energy file: the amplitude of the velocity profile and $1/\text{viscosity}$.

deform: (0 0 0 0 0 0) [nm ps⁻¹]

The velocities of deformation for the box elements: `a(x) b(y) c(z) b(x) c(x) c(y)`. Each step the box elements for which `deform` is non-zero are calculated as: `box(ts)+(t-ts)*deform`, off-diagonal elements are corrected for periodicity. The coordinates are transformed accordingly. Frozen degrees of freedom are (purposely) also transformed. The time `ts` is set to `t` at the first step and at steps at which `x` and `v` are written to trajectory to ensure exact restarts. Deformation can be used together with semiisotropic or anisotropic pressure coupling when the appropriate compressibilities are set to zero. The diagonal elements can be used to strain a solid. The off-diagonal elements can be used to shear a solid or a liquid.

7.3.26 Electric fields**E-x ; E-y ; E-z :**

If you want to use an electric field in a direction, enter 3 numbers after the appropriate `E-*`,

the first number: the number of cosines, only 1 is implemented (with frequency 0) so enter 1, the second number: the strength of the electric field in V nm^{-1} , the third number: the phase of the cosine, you can enter any number here since a cosine of frequency zero has no phase.

E-xt; E-yt; E-zt:
not implemented yet

h3: Mixed quantum/classical molecular dynamics; **!-QuietIdx:** QM/MM; **!-EQuietIdx-:** h^3

QMMM:

no
No QM/MM.

yes
Do a QM/MM simulation. Several groups can be described at different QM levels separately. These are specified in the **QMMM-grps** field separated by spaces. The level of **ijab initio/ij** theory at which the groups are described is specified by **QMmethod** and **QMbasis** fields. Describing the groups at different levels of theory is only possible with the ONIOM QM/MM scheme, specified by **QMMMscheme**.

QMMM-grps:
groups to be described at the QM level

QMMMscheme:

normal
normal QM/MM. There can only be one **QMMM-grps** that is modelled at the **QMmethod** and **QMbasis** level of *ab initio* theory. The rest of the system is described at the MM level. The QM and MM subsystems interact as follows: MM point charges are included in the QM one-electron hamiltonian and all Lennard-Jones interactions are described at the MM level.

ONIOM
The interaction between the subsystem is described using the ONIOM method by Morokuma and co-workers. There can be more than one **QMMM-grps** each modeled at a different level of QM theory (**QMmethod** and **QMbasis**).

QMmethod: (RHF)
Method used to compute the energy and gradients on the QM atoms. Available methods are AM1, PM3, RHF, UHF, DFT, B3LYP, MP2, CASSCF, and MMVB. For CASSCF, the number of electrons and orbitals included in the active space is specified by **CASelectrons** and **CASorbitals**.

QMbasis: (STO-3G)
Basis set used to expand the electronic wavefunction. Only Gaussian basis sets are currently available, i.e. STO-3G, 3-21G, 3-21G*, 3-21+G*, 6-21G, 6-31G, 6-31G*, 6-31+G*, and 6-311G.

QMcharge: (0) [integer]

The total charge in e of the QMMM-grps. In case there are more than one QMMM-grps, the total charge of each ONIOM layer needs to be specified separately.

QMmult: (1) [integer]

The multiplicity of the QMMM-grps. In case there are more than one QMMM-grps, the multiplicity of each ONIOM layer needs to be specified separately.

CASorbitals: (0) [integer]

The number of orbitals to be included in the active space when doing a CASSCF computation.

CASelectrons: (0) [integer]

The number of electrons to be included in the active space when doing a CASSCF computation.

SH:

no

No surface hopping. The system is always in the electronic ground-state.

yes

Do a QM/MM MD simulation on the excited state-potential energy surface and enforce a *diabatic* hop to the ground-state when the system hits the conical intersection hyperline in the course the simulation. This option only works in combination with the CASSCF method.

7.3.27 Implicit solvent

implicit-solvent:

no

No implicit solvent

GBSA

Do a simulation with implicit solvent using the Generalized Born formalism. Three different methods for calculating the Born radii are available, Still, HCT and OBC. These are specified with the `gb-algorithm` field. The non-polar solvation is specified with the `sa-algorithm` field.

gb-algorithm:

Still

Use the Still method to calculate the Born radii

HCT

Use the Hawkins-Cramer-Truhlar method to calculate the Born radii

OBC

Use the Onufriev-Bashford-Case method to calculate the Born radii

nstgbradii: (1) [steps]

Frequency to (re)-calculate the Born radii. For most practical purposes, setting a value larger than 1 violates energy conservation and leads to unstable trajectories.

rgbradii: (1.0) [nm]

Cut-off for the calculation of the Born radii. Currently must be equal to rlist

gb-epsilon-solvent: (80)

Dielectric constant for the implicit solvent

gb-saltconc: (0) [M]

Salt concentration for implicit solvent models, currently not used

gb-obc-alpha (1); gb-obc-beta (0.8); gb-obc-gamma (4.85);

Scale factors for the OBC model. Default values are OBC(II). Values for OBC(I) are 0.8, 0 and 2.91 respectively

gb-dielectric-offset: (0.009) [nm]

Distance for the dielectric offset when calculating the Born radii. This is the offset between the center of each atom the center of the polarization energy for the corresponding atom

sa-algorithm**Ace-approximation**

Use an Ace-type approximation (default)

None

No non-polar solvation calculation done. For GBSA only the polar part gets calculated

sa-surface-tension: [kJ mol⁻¹ nm⁻²]

Default value for surface tension with SA algorithms. The default value is -1; Note that if this default value is not changed it will be overridden by `grompp` using values that are specific for the choice of radii algorithm (0.0049 kcal/mol/Angstrom² for Still, 0.0054 kcal/mol/Angstrom² for HCT/OBC) Setting it to 0 will while using an sa-algorithm other than None means no non-polar calculations are done.

7.3.28 Adaptive Resolution Simulation**adress: (no)**

Decide whether the AdResS feature is turned on.

adress-type: (Off)**Off**

Do an AdResS simulation with weight equal 1, which is equivalent to an explicit (normal) MD simulation. The difference to disabled AdResS is that the AdResS variables are still read-in and hence are defined.

Constant

Do an AdResS simulation with a constant weight, `adress-const-wf` defines the value of the weight

XSplit

Do an AdResS simulation with simulation box split in x-direction, so basically the weight is only a function of the x coordinate and all distances are measured using the x coordinate only.

Sphere

Do an AdResS simulation with spherical explicit zone.

adress-const-wf: (1)

Provides the weight for a constant weight simulation (`adress-type=Constant`)

adress-ex-width: (0)

Width of the explicit zone, measured from `adress-reference-coords`.

adress-hy-width: (0)

Width of the hybrid zone.

adress-reference-coords: (0, 0, 0)

Position of the center of the explicit zone. Periodic boundary conditions apply for measuring the distance from it.

adress-cg-grp-names

The names of the coarse-grained energy groups. All other energy groups are considered explicit and their interactions will be automatically excluded with the coarse-grained groups.

adress-site: (COM) The mapping point from which the weight is calculated.**COM**

The weight is calculated from the center of mass of each charge group.

COG

The weight is calculated from the center of geometry of each charge group.

Atom

The weight is calculated from the position of 1st atom of each charge group.

AtomPerAtom

The weight is calculated from the position of each individual atom.

adress-interface-correction: (Off)**Off**

Do not apply any interface correction.

thermoforce

Apply thermodynamic force interface correction. The table can be specified using the `-tabletf` option of `mdrun`. The table should contain the potential and force (acting on molecules) as function of the distance from `adress-reference-coords`.

adress-tf-grp-names

The names of the energy groups to which the `thermoforce` is applied if enabled in `adress-interface-correction`. If no group is given the default table is applied.

adress-ex-forcecap: (0)

Cap the force in the hybrid region, useful for big molecules. 0 disables force capping.

7.3.29 User defined thingies

`user1-grps; user2-grps:`

`userint1 (0); userint2 (0); userint3 (0); userint4 (0)`

`userreal1 (0); userreal2 (0); userreal3 (0); userreal4 (0)`

These you can use if you modify code. You can pass integers and reals to your subroutine. Check the `inputrec` definition in `src/include/types/inputrec.h`

7.4 Programs by topic

Generating topologies and coordinates

<code>editconf</code>	edits the box and writes subgroups
<code>g_protonate</code>	protonates structures
<code>g_x2top</code>	generates a primitive topology from coordinates
<code>genbox</code>	solvates a system
<code>genconf</code>	multiplies a conformation in 'random' orientations
<code>genion</code>	generates mono atomic ions on energetically favorable positions
<code>genrestr</code>	generates position restraints or distance restraints for index groups
<code>pdb2gmx</code>	converts coordinate files to topology and FF-compliant coordinate files

Running a simulation

<code>grompp</code>	makes a run input file
<code>mdrun</code>	performs a simulation, do a normal mode analysis or an energy minimization
<code>tpbconv</code>	makes a run input file for restarting a crashed run

Viewing trajectories

<code>g_nmtraj</code>	generate a virtual trajectory from an eigenvector
<code>ngmx</code>	displays a trajectory

Processing energies

<code>g_enemat</code>	extracts an energy matrix from an energy file
<code>g_energy</code>	writes energies to xvg files and displays averages
<code>mdrun</code>	with <code>-rerun</code> (re)calculates energies for trajectory frames

Converting files

<code>editconf</code>	converts and manipulates structure files
<code>eneconv</code>	converts energy files
<code>g_sigeps</code>	convert <code>c6/12</code> or <code>c6/cn</code> combinations to and from <code>sigma/epsilon</code>
<code>trjcat</code>	concatenates trajectory files

<code>trjconv</code>	converts and manipulates trajectory files
<code>xpm2ps</code>	converts XPM matrices to encapsulated postscript (or XPM)

Tools

<code>g_analyze</code>	analyzes data sets
<code>g_dyndom</code>	interpolate and extrapolate structure rotations
<code>g_filter</code>	frequency filters trajectories, useful for making smooth movies
<code>g_lie</code>	free energy estimate from linear combinations
<code>g_morph</code>	linear interpolation of conformations
<code>g_pme_error</code>	estimates the error of using PME with a given input file
<code>g_select</code>	selects groups of atoms based on flexible textual selections
<code>g_sham</code>	read/write xmgr and xvgr data sets
<code>g_spatial</code>	calculates the spatial distribution function
<code>g_traj</code>	plots x, v and f of selected atoms/groups (and more) from a trajectory
<code>g_tune_pme</code>	time mdrun as a function of PME nodes to optimize settings
<code>g_wham</code>	weighted histogram analysis after umbrella sampling
<code>gmxcheck</code>	checks and compares files
<code>gmxdump</code>	makes binary files human readable
<code>make_ndx</code>	makes index files
<code>mk_angndx</code>	generates index files for g_angle
<code>trjorder</code>	orders molecules according to their distance to a group
<code>xpm2ps</code>	convert XPM (XPixelMap) file to postscript

Distances between structures

<code>g_cluster</code>	clusters structures
<code>g_confirms</code>	fits two structures and calculates the rmsd
<code>g_rms</code>	calculates rmsd's with a reference structure and rmsd matrices
<code>g_rmsf</code>	calculates atomic fluctuations

Distances in structures over time

<code>g_bond</code>	calculates distances between atoms
<code>g_dist</code>	calculates the distances between the centers of mass of two groups
<code>g_mindist</code>	calculates the minimum distance between two groups
<code>g_mdmat</code>	calculates residue contact maps
<code>g_polystat</code>	calculates static properties of polymers
<code>g_rmsdist</code>	calculates atom pair distances averaged with power -2, -3 or -6

Mass distribution properties over time

<code>g_gyrate</code>	calculates the radius of gyration
<code>g_msd</code>	calculates mean square displacements
<code>g_polystat</code>	calculates static properties of polymers
<code>g_rdf</code>	calculates radial distribution functions
<code>g_rotacf</code>	calculates the rotational correlation function for molecules
<code>g_rotmat</code>	plots the rotation matrix for fitting to a reference structure
<code>g_sans</code>	computes the small angle neutron scattering spectra

<code>g_traj</code>	plots x, v, f, box, temperature and rotational energy
<code>g_vanhove</code>	calculates Van Hove displacement functions

Analyzing bonded interactions

<code>g_angle</code>	calculates distributions and correlations for angles and dihedrals
<code>g_bond</code>	calculates bond length distributions
<code>mk_angndx</code>	generates index files for <code>g_angle</code>

Structural properties

<code>g_anadock</code>	cluster structures from Autodock runs
<code>g_bundle</code>	analyzes bundles of axes, <i>e.g.</i> helices
<code>g_clustsize</code>	calculate size distributions of atomic clusters
<code>g_disre</code>	analyzes distance restraints
<code>g_hbond</code>	computes and analyzes hydrogen bonds
<code>g_order</code>	computes the order parameter per atom for carbon tails
<code>g_principal</code>	calculates axes of inertia for a group of atoms
<code>g_rdf</code>	calculates radial distribution functions
<code>g_saltbr</code>	computes salt bridges
<code>g_sas</code>	computes solvent accessible surface area
<code>g_sgangle</code>	computes the angle and distance between two groups
<code>g_sorient</code>	analyzes solvent orientation around solutes
<code>g_spol</code>	analyzes solvent dipole orientation and polarization around solutes

Kinetic properties

<code>g_bar</code>	calculates free energy difference estimates through Bennett's acceptance ratio
<code>g_current</code>	calculate current autocorrelation function of system
<code>g_dos</code>	analyzes density of states and properties based on that
<code>g_dyecoupl</code>	extracts dye dynamics from trajectories
<code>g_kinetics</code>	analyzes kinetic constants from properties based on the Eyring model
<code>g_principal</code>	calculate principal axes of inertia for a group of atoms
<code>g_tcaf</code>	calculates viscosities of liquids
<code>g_traj</code>	plots x, v, f, box, temperature and rotational energy
<code>g_vanhove</code>	compute Van Hove correlation function
<code>g_velacc</code>	calculates velocity autocorrelation functions

Electrostatic properties

<code>g_current</code>	calculates dielectric constants for charged systems
<code>g_dielectric</code>	calculates frequency dependent dielectric constants
<code>g_dipoles</code>	computes the total dipole plus fluctuations
<code>g_potential</code>	calculates the electrostatic potential across the box
<code>g_spol</code>	analyze dipoles around a solute
<code>genion</code>	generates mono atomic ions on energetically favorable positions

Protein-specific analysis

do_dssp	assigns secondary structure and calculates solvent accessible surface area
g_chi	calculates everything you want to know about chi and other dihedrals
g_helix	calculates basic properties of alpha helices
g_helixorient	calculates local pitch/bending/rotation/orientation inside helices
g_rama	computes Ramachandran plots
g_wheel	plots helical wheels
g_xrama	shows animated Ramachandran plots

Interfaces

g_bundle	analyzes bundles of axes, <i>e.g.</i> transmembrane helices
g_density	calculates the density of the system
g_densmap	calculates 2D planar or axial-radial density maps
g_densorder	calculate surface fluctuations
g_h2order	computes the orientation of water molecules
g_hydorder	computes tetrahedrality parameters around a given atom
g_order	computes the order parameter per atom for carbon tails
g_membed	embeds a protein into a lipid bilayer
g_potential	calculates the electrostatic potential across the box

Covariance analysis

g_anaeig	analyzes the eigenvectors
g_covar	calculates and diagonalizes the covariance matrix
make_edi	generate input files for essential dynamics sampling

Normal modes

g_anaeig	analyzes the normal modes
g_nmeig	diagonalizes the Hessian
g_nmtraj	generate oscillating trajectory of an eigenmode
g_nmens	generates an ensemble of structures from the normal modes
grompp	makes a run input file
mdrun	finds a potential energy minimum and calculates the Hessian

Chapter 8

Analysis

In this chapter different ways of analyzing your trajectory are described. The names of the corresponding analysis programs are given. Specific information on the in- and output of these programs can be found in the online manual at www.gromacs.org. The output files are often produced as finished Grace/Xmgr graphs.

First, in sec. 8.1, the group concept in analysis is explained. Then, the different analysis tools are presented.

8.1 Using Groups

`make_ndx`, `mk_angndx`

In chapter 3, it was explained how *groups of atoms* can be used in `mdrun` (see sec. 3.3). In most analysis programs, groups of atoms must also be chosen. Most programs can generate several default index groups, but groups can always be read from an index file. Let's consider the example of a simulation of a binary mixture of components A and B. When we want to calculate the radial distribution function (RDF) $g_{AB}(r)$ of A with respect to B, we have to calculate:

$$4\pi r^2 g_{AB}(r) = V \sum_{i \in A} \sum_{j \in B} P(r) \quad (8.1)$$

where V is the volume and $P(r)$ is the probability of finding a B atom at distance r from an A atom.

By having the user define the *atom numbers* for groups A and B in a simple file, we can calculate this g_{AB} in the most general way, without having to make any assumptions in the RDF program about the type of particles.

Groups can therefore consist of a series of *atom numbers*, but in some cases also of *molecule numbers*. It is also possible to specify a series of angles by *triples of atom numbers*, dihedrals by *quadruples of atom numbers* and bonds or vectors (in a molecule) by *pairs of atom numbers*. When appropriate the type of index file will be specified for the following analysis programs. To

help creating such index files (`index.ndx`), there are a couple of programs to generate them, using either your input configuration or the topology. To generate an index file consisting of a series of *atom numbers* (as in the example of g_{AB}), use `make_ndx` or `g_select`. To generate an index file with angles or dihedrals, use `mk_angndx`. Of course you can also make them by hand. The general format is presented here:

```
[ Oxygen ]
  1      4      7

[ Hydrogen ]
  2      3      5      6
  8      9
```

First, the group name is written between square brackets. The following atom numbers may be spread out over as many lines as you like. The atom numbering starts at 1.

Each tool that can use groups will offer the available alternatives for the user to choose. That choice can be made with the number of the group, or its name. In fact, the first few letters of the group name will suffice if that will distinguish the group from all others. There are ways to use Unix shell features to choose group names on the command line, rather than interactively. Consult www.gromacs.org for suggestions.

8.1.1 Default Groups

When no index file is supplied to analysis tools or `grompp`, a number of default groups are generated to choose from:

```
System
  all atoms in the system

Protein
  all protein atoms

Protein-H
  protein atoms excluding hydrogens

C-alpha
  Cα atoms

Backbone
  protein backbone atoms; N, Cα and C

MainChain
  protein main chain atoms: N, Cα, C and O, including oxygens in C-terminus

MainChain+Cb
  protein main chain atoms including Cβ
```

MainChain+H	protein main chain atoms including backbone amide hydrogens and hydrogens on the N-terminus
SideChain	protein side chain atoms; that is all atoms except N, C _α , C, O, backbone amide hydrogens, oxygens in C-terminus and hydrogens on the N-terminus
SideChain-H	protein side chain atoms excluding all hydrogens
Prot-Masses	protein atoms excluding dummy masses (as used in virtual site constructions of NH ₃ groups and tryptophan side-chains), see also sec. 5.2.2; this group is only included when it differs from the “Protein” group
Non-Protein	all non-protein atoms
DNA	all DNA atoms
RNA	all RNA atoms
Water	water molecules (names like SOL, WAT, HOH, etc.) See <code>residuetypes.dat</code> for a full listing
non-Water	anything not covered by the Water group
Ion	any name matching an Ion entry in <code>residuetypes.dat</code>
Water_and_Ions	combination of the Water and Ions groups
molecule_name	for all residues/molecules which are not recognized as protein, DNA, or RNA; one group per residue/molecule name is generated
Other	all atoms which are neither protein, DNA, nor RNA.

Empty groups will not be generated. Most of the groups only contain protein atoms. An atom is considered a protein atom if its residue name is listed in the `residuetypes.dat` file and is listed as a “Protein” entry. The process for determining DNA, RNA, etc. is analogous. If you need to modify these classifications, then you can copy the file from the library directory into your working directory and edit the local copy.

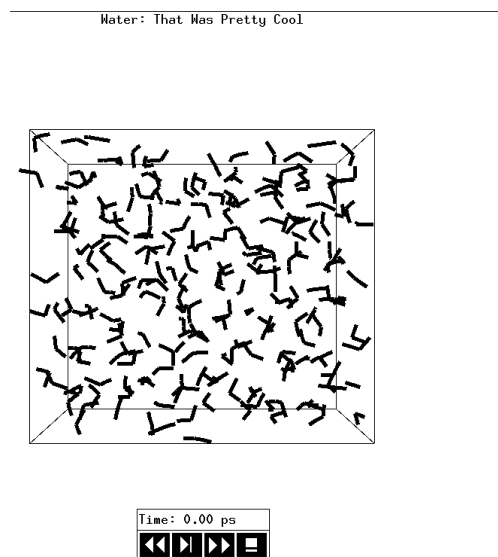

Figure 8.1: The window of `ngmx` showing a box of water.

8.1.2 Selections

`g_select`

GROMACS also includes a `g_select` tool that can be used to select atoms based on more flexible criteria than in `make_ndx`, including selecting atoms based on their coordinates. Currently, the tool is experimental and only supports some basic operations, but in the future the functionality is planned to be included in other analysis tools as well. A description of possible ways to select atoms can be read by running `g_select` and typing `help` at the selection prompt that appears. It is also possible to write your own analysis tools to take advantage of the flexibility of these selections: see the `template.c` file in the `share/gromacs/template` directory of your installation for an example.

8.2 Looking at your trajectory

`ngmx`

Before analyzing your trajectory it is often informative to look at your trajectory first. GROMACS comes with a simple trajectory viewer `ngmx`; the advantage with this one is that it does not require OpenGL, which usually isn't present on *e.g.* supercomputers. It is also possible to generate a hard-copy in Encapsulated Postscript format (see Fig. 8.1). If you want a faster and more fancy viewer there are several programs that can read the GROMACS trajectory formats – have a look at our homepage (www.gromacs.org) for updated links.

8.3 General properties

`g_energy`, `g_traj`

To analyze some or all *energies* and other properties, such as *total pressure*, *pressure tensor*, *density*, *box-volume* and *box-sizes*, use the program `g_energy`. A choice can be made from a list a set of energies, like potential, kinetic or total energy, or individual contributions, like Lennard-Jones or dihedral energies.

The *center-of-mass velocity*, defined as

$$\mathbf{v}_{com} = \frac{1}{M} \sum_{i=1}^N m_i \mathbf{v}_i \quad (8.2)$$

with $M = \sum_{i=1}^N m_i$ the total mass of the system, can be monitored in time by the program `g_traj -com -ov`. It is however recommended to remove the center-of-mass velocity every step (see chapter 3)!

8.4 Radial distribution functions

`g_rdf`

The *radial distribution function* (RDF) or pair correlation function $g_{AB}(r)$ between particles of type *A* and *B* is defined in the following way:

$$\begin{aligned} g_{AB}(r) &= \frac{\langle \rho_B(r) \rangle}{\langle \rho_B \rangle_{local}} \\ &= \frac{1}{\langle \rho_B \rangle_{local}} \frac{1}{N_A} \sum_{i \in A} \sum_{j \in B} \frac{\delta(r_{ij} - r)}{4\pi r^2} \end{aligned} \quad (8.3)$$

with $\langle \rho_B(r) \rangle$ the particle density of type *B* at a distance *r* around particles *A*, and $\langle \rho_B \rangle_{local}$ the particle density of type *B* averaged over all spheres around particles *A* with radius r_{max} (see Fig. 8.2C).

Usually the value of r_{max} is half of the box length. The averaging is also performed in time. In practice the analysis program `g_rdf` divides the system into spherical slices (from *r* to $r + dr$, see Fig. 8.2A) and makes a histogram in stead of the δ -function. An example of the RDF of oxygen-oxygen in SPC water [80] is given in Fig. 8.3.

With `g_rdf` it is also possible to calculate an angle dependent rdf $g_{AB}(r, \theta)$, where the angle θ is defined with respect to a certain laboratory axis *e*, see Fig. 8.2B.

$$g_{AB}(r, \theta) = \frac{1}{\langle \rho_B \rangle_{local, \theta}} \frac{1}{N_A} \sum_{i \in A} \sum_{j \in B} \frac{\delta(r_{ij} - r) \delta(\theta_{ij} - \theta)}{2\pi r^2 \sin(\theta)} \quad (8.4)$$

$$\cos(\theta_{ij}) = \frac{\mathbf{r}_{ij} \cdot \mathbf{e}}{\|\mathbf{r}_{ij}\| \|\mathbf{e}\|} \quad (8.5)$$

This $g_{AB}(r, \theta)$ is useful for analyzing anisotropic systems. **Note** that in this case the normalization $\langle \rho_B \rangle_{local, \theta}$ is the average density in all angle slices from θ to $\theta + d\theta$ up to r_{max} , so angle dependent, see Fig. 8.2D.

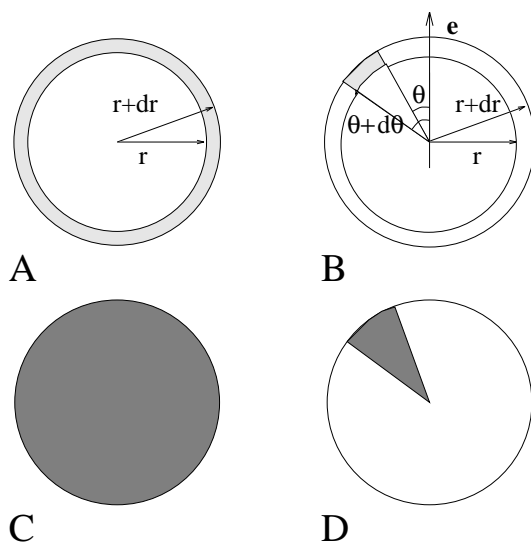

Figure 8.2: Definition of slices in g_rdf : A. $g_{AB}(r)$. B. $g_{AB}(r, \theta)$. The slices are colored gray. C. Normalization $\langle \rho_B \rangle_{local}$. D. Normalization $\langle \rho_B \rangle_{local, \theta}$. Normalization volumes are colored gray.

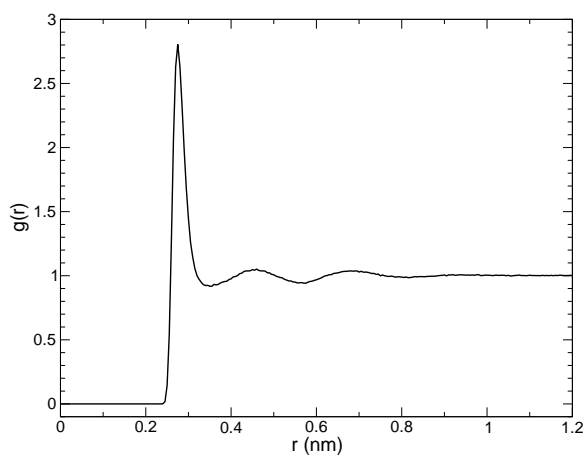

Figure 8.3: $g_{OO}(r)$ for Oxygen-Oxygen of SPC-water.

8.5 Correlation functions

8.5.1 Theory of correlation functions

The theory of correlation functions is well established [98]. We describe here the implementation of the various correlation function flavors in the GROMACS code. The definition of the (ACF) $C_f(t)$ for a property $f(t)$ is:

$$C_f(t) = \langle f(\xi)f(\xi + t) \rangle_{\xi} \quad (8.6)$$

where the notation on the right hand side indicates averaging over ξ , *i.e.* over time origins. It is also possible to compute cross-correlation function from two properties $f(t)$ and $g(t)$:

$$C_{fg}(t) = \langle f(\xi)g(\xi + t) \rangle_{\xi} \quad (8.7)$$

however, in GROMACS there is no standard mechanism to do this (**note:** you can use the `xmgr` program to compute cross correlations). The integral of the correlation function over time is the correlation time τ_f :

$$\tau_f = \int_0^{\infty} C_f(t) dt \quad (8.8)$$

In practice, correlation functions are calculated based on data points with discrete time intervals Δt , so that the ACF from an MD simulation is:

$$C_f(j\Delta t) = \frac{1}{N-j} \sum_{i=0}^{N-1-j} f(i\Delta t)f((i+j)\Delta t) \quad (8.9)$$

where N is the number of available time frames for the calculation. The resulting ACF is obviously only available at time points with the same interval Δt . Since, for many applications, it is necessary to know the short time behavior of the ACF (*e.g.* the first 10 ps) this often means that we have to save the data with intervals much shorter than the time scale of interest. Another implication of eqn. 8.9 is that in principle we can not compute all points of the ACF with the same accuracy, since we have $N-1$ data points for $C_f(\Delta t)$ but only 1 for $C_f((N-1)\Delta t)$. However, if we decide to compute only an ACF of length $M\Delta t$, where $M \leq N/2$ we can compute all points with the same statistical accuracy:

$$C_f(j\Delta t) = \frac{1}{M} \sum_{i=0}^{N-1-M} f(i\Delta t)f((i+j)\Delta t) \quad (8.10)$$

Here of course $j < M$. M is sometimes referred to as the time lag of the correlation function. When we decide to do this, we intentionally do not use all the available points for very short time intervals ($j \ll M$), but it makes it easier to interpret the results. Another aspect that may not be neglected when computing ACFs from simulation is that usually the time origins ξ (eqn. 8.6) are not statistically independent, which may introduce a bias in the results. This can be tested using a block-averaging procedure, where only time origins with a spacing at least the length of the time lag are included, *e.g.* using k time origins with spacing of $M\Delta t$ (where $kM \leq N$):

$$C_f(j\Delta t) = \frac{1}{k} \sum_{i=0}^{k-1} f(iM\Delta t)f((iM+j)\Delta t) \quad (8.11)$$

However, one needs very long simulations to get good accuracy this way, because there are many fewer points that contribute to the ACF.

8.5.2 Using FFT for computation of the ACF

The computational cost for calculating an ACF according to eqn. 8.9 is proportional to N^2 , which is considerable. However, this can be improved by using fast Fourier transforms to do the convolution [98].

8.5.3 Special forms of the ACF

There are some important varieties on the ACF, *e.g.* the ACF of a vector \mathbf{p} :

$$C_{\mathbf{p}}(t) = \int_0^\infty P_n(\cos \angle(\mathbf{p}(\xi), \mathbf{p}(\xi + t))) d\xi \quad (8.12)$$

where $P_n(x)$ is the n^{th} order Legendre polynomial¹. Such correlation times can actually be obtained experimentally using *e.g.* NMR or other relaxation experiments. GROMACS can compute correlations using the 1st and 2nd order Legendre polynomial (eqn. 8.12). This can also be used for rotational autocorrelation (`g_rotacf`) and dipole autocorrelation (`g_dipoles`).

In order to study torsion angle dynamics, we define a dihedral autocorrelation function as [149]:

$$C(t) = \langle \cos(\theta(\tau) - \theta(\tau + t)) \rangle_\tau \quad (8.13)$$

Note that this is not a product of two functions as is generally used for correlation functions, but it may be rewritten as the sum of two products:

$$C(t) = \langle \cos(\theta(\tau)) \cos(\theta(\tau + t)) + \sin(\theta(\tau)) \sin(\theta(\tau + t)) \rangle_\tau \quad (8.14)$$

8.5.4 Some Applications

The program `g_velacc` calculates the *velocity autocorrelation function*.

$$C_{\mathbf{v}}(\tau) = \langle \mathbf{v}_i(\tau) \cdot \mathbf{v}_i(0) \rangle_{i \in A} \quad (8.15)$$

The self diffusion coefficient can be calculated using the Green-Kubo relation [98]:

$$D_A = \frac{1}{3} \int_0^\infty \langle \mathbf{v}_i(t) \cdot \mathbf{v}_i(0) \rangle_{i \in A} dt \quad (8.16)$$

which is just the integral of the velocity autocorrelation function. There is a widely-held belief that the velocity ACF converges faster than the mean square displacement (sec. 8.6), which can also be used for the computation of diffusion constants. However, Allen & Tildesley [98] warn us that the long-time contribution to the velocity ACF can not be ignored, so care must be taken.

Another important quantity is the dipole correlation time. The *dipole correlation function* for particles of type A is calculated as follows by `g_dipoles`:

$$C_{\mu}(\tau) = \langle \mu_i(\tau) \cdot \mu_i(0) \rangle_{i \in A} \quad (8.17)$$

¹ $P_0(x) = 1, P_1(x) = x, P_2(x) = (3x^2 - 1)/2$

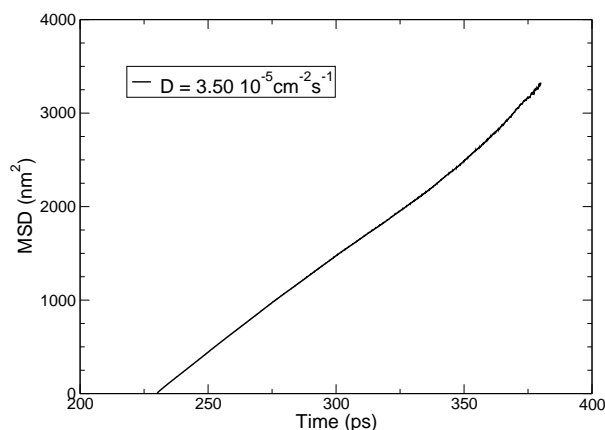

Figure 8.4: Mean Square Displacement of SPC-water.

with $\mu_i = \sum_{j \in i} \mathbf{r}_j q_j$. The dipole correlation time can be computed using eqn. 8.8. For some applications see [150].

The viscosity of a liquid can be related to the correlation time of the Pressure tensor \mathbf{P} [151, 152]. `g_energy` can compute the viscosity, but this is not very accurate [133], and actually the values do not converge.

8.6 Mean Square Displacement

`g_msd`

To determine the self D_A of particles of type A , one can use the Einstein relation [98]:

$$\lim_{t \rightarrow \infty} \langle \|\mathbf{r}_i(t) - \mathbf{r}_i(0)\|^2 \rangle_{i \in A} = 6D_A t \quad (8.18)$$

This *mean square displacement* and D_A are calculated by the program `g_msd`. Normally an index file containing atom numbers is used and the MSD is averaged over these atoms. For molecules consisting of more than one atom, \mathbf{r}_i can be taken as the center of mass positions of the molecules. In that case, you should use an index file with molecule numbers. The results will be nearly identical to averaging over atoms, however. The `g_msd` program can also be used for calculating diffusion in one or two dimensions. This is useful for studying lateral diffusion on interfaces.

An example of the mean square displacement of SPC water is given in Fig. 8.4.

8.7 Bonds, angles and dihedrals

`g_bond`, `g_angle`, `g_sgangle`

To monitor specific *bonds* in your molecules during time, the program `g_bond` calculates the distribution of the bond length in time. The index file consists of pairs of atom numbers, for example

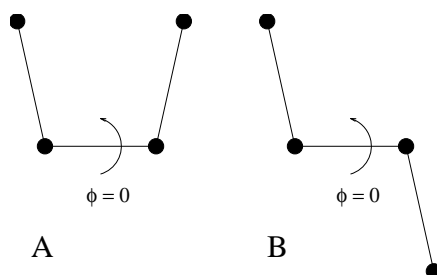

Figure 8.5: Dihedral conventions: A. “Biochemical convention”. B. “Polymer convention”.

```
[ bonds_1 ]
1     2
3     4
9     10
```

```
[ bonds_2 ]
12    13
```

The program `g_angle` calculates the distribution of *angles* and *dihedrals* in time. It also gives the average angle or dihedral. The index file consists of triplets or quadruples of atom numbers:

```
[ angles ]
1     2     3
2     3     4
3     4     5
```

```
[ dihedrals ]
1     2     3     4
2     3     5     5
```

For the dihedral angles you can use either the “biochemical convention” ($\phi = 0 \equiv cis$) or “polymer convention” ($\phi = 0 \equiv trans$), see Fig. 8.5.

To follow specific *angles* in time between two vectors, a vector and a plane or two planes (defined by 2 or 3 atoms, respectively, inside your molecule, see Fig. 8.6A, B, C), use the program `g_sgangle`.

For planes, `g_sgangle` uses the normal vector perpendicular to the plane. It can also calculate the *distance* d between the geometrical center of two planes (see Fig. 8.6D), and the distances d_1 and d_2 between 2 atoms (of a vector) and the center of a plane defined by 3 atoms (see Fig. 8.6D). It further calculates the distance d between the center of the plane and the middle of this vector. Depending on the input groups (*i.e.* groups of 2 or 3 atom numbers), the program decides what angles and distances to calculate. For example, the index-file could look like this:

```
[ a_plane ]
1     2     3
```

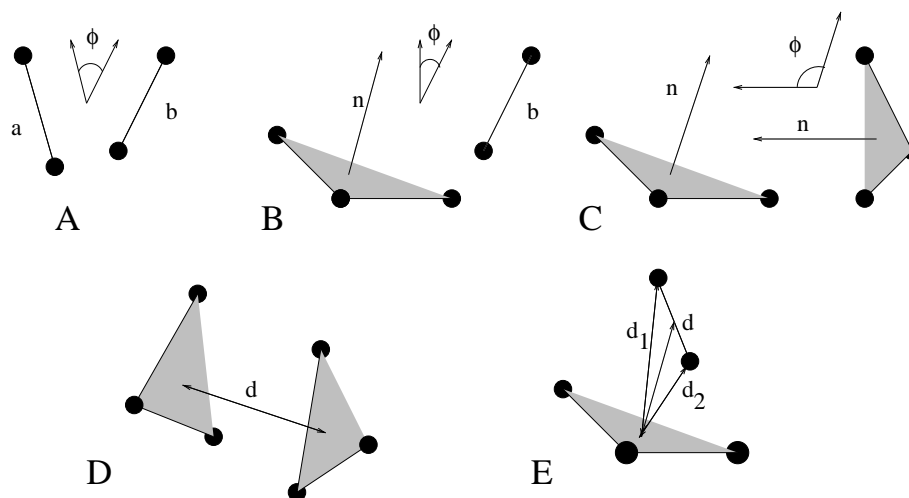

Figure 8.6: Options of `g_sgangle`: A. Angle between 2 vectors. B. Angle between a vector and the normal of a plane. C. Angle between two planes. D. Distance between the geometrical centers of 2 planes. E. Distances between a vector and the center of a plane.

```
[ a_vector ]
  4       5
```

8.8 Radius of gyration and distances

`g_gyrate`, `g_sgangle`, `g_mindist`, `g_mdmat`, `xpm2ps`

To have a rough measure for the compactness of a structure, you can calculate the *radius of gyration* with the program `g_gyrate` as follows:

$$R_g = \left(\frac{\sum_i \|\mathbf{r}_i\|^2 m_i}{\sum_i m_i} \right)^{\frac{1}{2}} \quad (8.19)$$

where m_i is the mass of atom i and \mathbf{r}_i the position of atom i with respect to the center of mass of the molecule. It is especially useful to characterize polymer solutions and proteins.

Sometimes it is interesting to plot the *distance* between two atoms, or the *minimum* distance between two groups of atoms (e.g.: protein side-chains in a salt bridge). To calculate these distances between certain groups there are several possibilities:

- The *distance between the geometrical centers* of two groups can be calculated with the program `g_sgangle`, as explained in sec. 8.7.
- The *minimum distance* between two groups of atoms during time can be calculated with the program `g_mindist`. It also calculates the *number of contacts* between these groups within a certain radius r_{max} .
- To monitor the *minimum distances between amino acid residues* within a (protein) molecule, you can use the program `g_mdmat`. This minimum distance between two residues A_i and

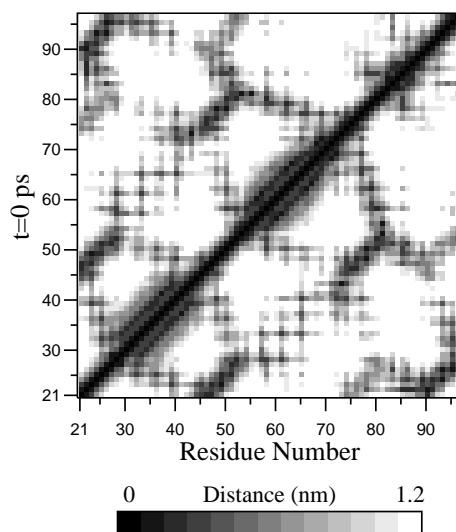

Figure 8.7: A minimum distance matrix for a peptide [153].

A_j is defined as the smallest distance between any pair of atoms ($i \in A_i, j \in A_j$). The output is a symmetrical matrix of smallest distances between all residues. To visualize this matrix, you can use a program such as `xv`. If you want to view the axes and legend or if you want to print the matrix, you can convert it with `xpm2ps` into a Postscript picture, see Fig. 8.7.

Plotting these matrices for different time-frames, one can analyze changes in the structure, and *e.g.* forming of salt bridges.

8.9 Root mean square deviations in structure

`g_rms`, `g_rmsdist`

The *root mean square deviation (RMSD)* of certain atoms in a molecule with respect to a reference structure can be calculated with the program `g_rms` by least-square fitting the structure to the reference structure ($t_2 = 0$) and subsequently calculating the *RMSD* (eqn. 8.20).

$$RMSD(t_1, t_2) = \left[\frac{1}{M} \sum_{i=1}^N m_i \|\mathbf{r}_i(t_1) - \mathbf{r}_i(t_2)\|^2 \right]^{\frac{1}{2}} \quad (8.20)$$

where $M = \sum_{i=1}^N m_i$ and $\mathbf{r}_i(t)$ is the position of atom i at time t . **Note** that fitting does not have to use the same atoms as the calculation of the *RMSD*; *e.g.* a protein is usually fitted on the backbone atoms (N,C $_{\alpha}$,C), but the *RMSD* can be computed of the backbone or of the whole protein.

Instead of comparing the structures to the initial structure at time $t = 0$ (so for example a crystal structure), one can also calculate eqn. 8.20 with a structure at time $t_2 = t_1 - \tau$. This gives some insight in the mobility as a function of τ . A matrix can also be made with the *RMSD* as a function of t_1 and t_2 , which gives a nice graphical interpretation of a trajectory. If there are transitions in a trajectory, they will clearly show up in such a matrix.

Alternatively the *RMSD* can be computed using a fit-free method with the program `g_rmsdist`:

$$RMSD(t) = \left[\frac{1}{N^2} \sum_{i=1}^N \sum_{j=1}^N \|\mathbf{r}_{ij}(t) - \mathbf{r}_{ij}(0)\|^2 \right]^{\frac{1}{2}} \quad (8.21)$$

where the *distance* \mathbf{r}_{ij} between atoms at time t is compared with the distance between the same atoms at time 0.

8.10 Covariance analysis

Covariance analysis, also called principal component analysis or essential dynamics [154], can find correlated motions. It uses the covariance matrix C of the atomic coordinates:

$$C_{ij} = \left\langle M_{ii}^{\frac{1}{2}}(x_i - \langle x_i \rangle) M_{jj}^{\frac{1}{2}}(x_j - \langle x_j \rangle) \right\rangle \quad (8.22)$$

where M is a diagonal matrix containing the masses of the atoms (mass-weighted analysis) or the unit matrix (non-mass weighted analysis). C is a symmetric $3N \times 3N$ matrix, which can be diagonalized with an orthonormal transformation matrix R :

$$R^T C R = \text{diag}(\lambda_1, \lambda_2, \dots, \lambda_{3N}) \quad \text{where } \lambda_1 \geq \lambda_2 \geq \dots \geq \lambda_{3N} \quad (8.23)$$

The columns of R are the eigenvectors, also called principal or essential modes. R defines a transformation to a new coordinate system. The trajectory can be projected on the principal modes to give the principal components $p_i(t)$:

$$\mathbf{p}(t) = R^T M^{\frac{1}{2}}(\mathbf{x}(t) - \langle \mathbf{x} \rangle) \quad (8.24)$$

The eigenvalue λ_i is the mean square fluctuation of principal component i . The first few principal modes often describe collective, global motions in the system. The trajectory can be filtered along one (or more) principal modes. For one principal mode i this goes as follows:

$$\mathbf{x}^f(t) = \langle \mathbf{x} \rangle + M^{-\frac{1}{2}} R_{*i} p_i(t) \quad (8.25)$$

When the analysis is performed on a macromolecule, one often wants to remove the overall rotation and translation to look at the internal motion only. This can be achieved by least square fitting to a reference structure. Care has to be taken that the reference structure is representative for the ensemble, since the choice of reference structure influences the covariance matrix.

One should always check if the principal modes are well defined. If the first principal component resembles a half cosine and the second resembles a full cosine, you might be filtering noise (see below). A good way to check the relevance of the first few principal modes is to calculate the overlap of the sampling between the first and second half of the simulation. **Note** that this can only be done when the same reference structure is used for the two halves.

A good measure for the overlap has been defined in [155]. The elements of the covariance matrix are proportional to the square of the displacement, so we need to take the square root of the matrix to examine the extent of sampling. The square root can be calculated from the eigenvalues λ_i and

the eigenvectors, which are the columns of the rotation matrix R . For a symmetric and diagonally-dominant matrix A of size $3N \times 3N$ the square root can be calculated as:

$$A^{\frac{1}{2}} = R \operatorname{diag}(\lambda_1^{\frac{1}{2}}, \lambda_2^{\frac{1}{2}}, \dots, \lambda_{3N}^{\frac{1}{2}}) R^T \quad (8.26)$$

It can be verified easily that the product of this matrix with itself gives A . Now we can define a difference d between covariance matrices A and B as follows:

$$d(A, B) = \sqrt{\operatorname{tr} \left((A^{\frac{1}{2}} - B^{\frac{1}{2}})^2 \right)} \quad (8.27)$$

$$= \sqrt{\operatorname{tr} \left(A + B - 2A^{\frac{1}{2}}B^{\frac{1}{2}} \right)} \quad (8.28)$$

$$= \left(\sum_{i=1}^N (\lambda_i^A + \lambda_i^B) - 2 \sum_{i=1}^N \sum_{j=1}^N \sqrt{\lambda_i^A \lambda_j^B} (R_i^A \cdot R_j^B)^2 \right)^{\frac{1}{2}} \quad (8.29)$$

where tr is the trace of a matrix. We can now define the overlap s as:

$$s(A, B) = 1 - \frac{d(A, B)}{\sqrt{\operatorname{tr}A + \operatorname{tr}B}} \quad (8.30)$$

The overlap is 1 if and only if matrices A and B are identical. It is 0 when the sampled subspaces are completely orthogonal.

A commonly-used measure is the subspace overlap of the first few eigenvectors of covariance matrices. The overlap of the subspace spanned by m orthonormal vectors $\mathbf{w}_1, \dots, \mathbf{w}_m$ with a reference subspace spanned by n orthonormal vectors $\mathbf{v}_1, \dots, \mathbf{v}_n$ can be quantified as follows:

$$\operatorname{overlap}(\mathbf{v}, \mathbf{w}) = \frac{1}{n} \sum_{i=1}^n \sum_{j=1}^m (\mathbf{v}_i \cdot \mathbf{w}_j)^2 \quad (8.31)$$

The overlap will increase with increasing m and will be 1 when set \mathbf{v} is a subspace of set \mathbf{w} . The disadvantage of this method is that it does not take the eigenvalues into account. All eigenvectors are weighted equally, and when degenerate subspaces are present (equal eigenvalues), the calculated overlap will be too low.

Another useful check is the cosine content. It has been proven that the the principal components of random diffusion are cosines with the number of periods equal to half the principal component index [156, 155]. The eigenvalues are proportional to the index to the power -2 . The cosine content is defined as:

$$\frac{2}{T} \left(\int_0^T \cos \left(\frac{i\pi t}{T} \right) p_i(t) dt \right)^2 \left(\int_0^T p_i^2(t) dt \right)^{-1} \quad (8.32)$$

When the cosine content of the first few principal components is close to 1, the largest fluctuations are not connected with the potential, but with random diffusion.

The covariance matrix is built and diagonalized by `g_covar`. The principal components and overlap (and many more things) can be plotted and analyzed with `g_anaeig`. The cosine content can be calculated with `g_analyze`.

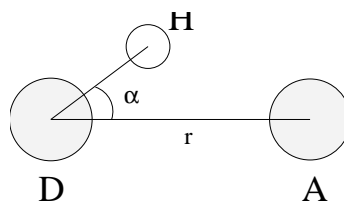

Figure 8.8: Geometrical Hydrogen bond criterion.

8.11 Dihedral principal component analysis

`g_angle`, `g_covar`, `g_anaeig`

Principal component analysis can be performed in dihedral space [157] using GROMACS. You start by defining the dihedral angles of interest in an index file, either using `mk_angndx` or otherwise. Then you use the `g_angle` program with the `-or` flag to produce a new `.trr` file containing the cosine and sine of each dihedral angle in two coordinates, respectively. That is, in the `.trr` file you will have a series of numbers corresponding to: $\cos(\phi_1)$, $\sin(\phi_1)$, $\cos(\phi_2)$, $\sin(\phi_2)$, ..., $\cos(\phi_n)$, $\sin(\phi_n)$, and the array is padded with zeros, if necessary. Then you can use this `.trr` file as input for the `g_covar` program and perform principal component analysis as usual. For this to work you will need to generate a reference file (`.tpr`, `.gro`, `.pdb` etc.) containing the same number of “atoms” as the new `.trr` file, that is for n dihedrals you need $2n/3$ atoms (rounded up if not an integer number). You should use the `-nofit` option for `g_covar` since the coordinates in the dummy reference file do not correspond in any way to the information in the `.trr` file. Analysis of the results is done using `g_anaeig`.

8.12 Hydrogen bonds

`g_hbond`

The program `g_hbond` analyzes the *hydrogen bonds* (H-bonds) between all possible donors D and acceptors A. To determine if an H-bond exists, a geometrical criterion is used, see also Fig. 8.8:

$$\begin{aligned} r &\leq r_{HB} = 0.35 \text{ nm} \\ \alpha &\leq \alpha_{HB} = 30^\circ \end{aligned} \quad (8.33)$$

The value of $r_{HB} = 0.35$ nm corresponds to the first minimum of the RDF of SPC water (see also Fig. 8.3).

The program `g_hbond` analyzes all hydrogen bonds existing between two groups of atoms (which must be either identical or non-overlapping) or in specified donor-hydrogen-acceptor triplets, in the following ways:

- Donor-Acceptor distance (r) distribution of all H-bonds
- Hydrogen-Donor-Acceptor angle (α) distribution of all H-bonds
- The total number of H-bonds in each time frame

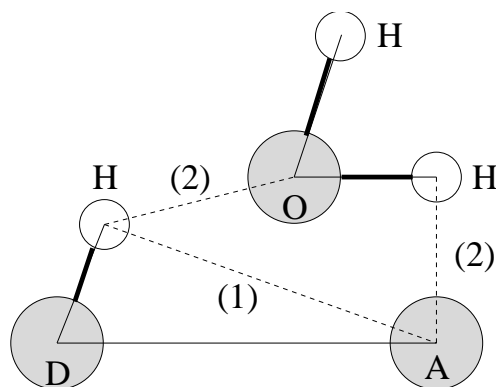

Figure 8.9: Insertion of water into an H-bond. (1) Normal H-bond between two residues. (2) H-bonding bridge via a water molecule.

- The number of H-bonds in time between residues, divided into groups $n-n+i$ where n and $n+i$ stand for residue numbers and i goes from 0 to 6. The group for $i = 6$ also includes all H-bonds for $i > 6$. These groups include the $n-n+3$, $n-n+4$ and $n-n+5$ H-bonds, which provide a measure for the formation of α -helices or β -turns or strands.
- The lifetime of the H-bonds is calculated from the average over all autocorrelation functions of the existence functions (either 0 or 1) of all H-bonds:

$$C(\tau) = \langle s_i(t) s_i(t + \tau) \rangle \quad (8.34)$$

with $s_i(t) = \{0, 1\}$ for H-bond i at time t . The integral of $C(\tau)$ gives a rough estimate of the average H-bond lifetime τ_{HB} :

$$\tau_{HB} = \int_0^{\infty} C(\tau) d\tau \quad (8.35)$$

Both the integral and the complete autocorrelation function $C(\tau)$ will be output, so that more sophisticated analysis (*e.g.* using multi-exponential fits) can be used to get better estimates for τ_{HB} . A more complete analysis is given in ref. [158]; one of the more fancy option is the Luzar and Chandler analysis of hydrogen bond kinetics [159, 160].

- An H-bond existence map can be generated of dimensions $\# H\text{-bonds} \times \# \text{frames}$. The ordering is identical to the index file (see below), but reversed, meaning that the last triplet in the index file corresponds to the first row of the existence map.
- Index groups are output containing the analyzed groups, all donor-hydrogen atom pairs and acceptor atoms in these groups, donor-hydrogen-acceptor triplets involved in hydrogen bonds between the analyzed groups and all solvent atoms involved in insertion.

8.13 Protein-related items

`do_dssp`, `g_rama`, `g_xrama`, `g_wheel`

To analyze structural changes of a protein, you can calculate the radius of gyration or the minimum residue distances over time (see sec. 8.8), or calculate the RMSD (sec. 8.9).

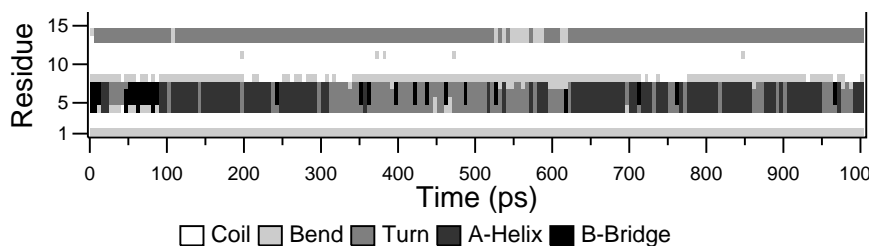

Figure 8.10: Analysis of the secondary structure elements of a peptide in time.

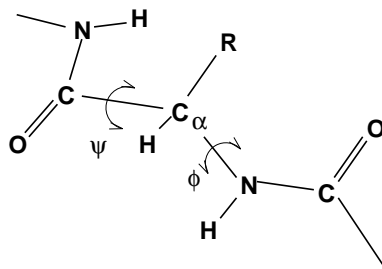

Figure 8.11: Definition of the dihedral angles ϕ and ψ of the protein backbone.

You can also look at the changing of *secondary structure elements* during your run. For this, you can use the program `do_dssp`, which is an interface for the commercial program DSSP [161]. For further information, see the DSSP manual. A typical output plot of `do_dssp` is given in Fig. 8.10.

One other important analysis of proteins is the so-called *Ramachandran plot*. This is the projection of the structure on the two dihedral angles ϕ and ψ of the protein backbone, see Fig. 8.11.

To evaluate this Ramachandran plot you can use the program `g_rama`. A typical output is given in Fig. 8.12.

It is also possible to generate an animation of the Ramachandran plot in time. This can be useful for analyzing certain dihedral transitions in your protein. You can use the program `g_xrama` for this.

When studying α -helices it is useful to have a *helical wheel* projection of your peptide, to see whether a peptide is amphipathic. This can be done using the `g_wheel` program. Two examples are plotted in Fig. 8.13.

8.14 Interface-related items

`g_order`, `g_density`, `g_potential`, `g_traj`

When simulating molecules with long carbon tails, it can be interesting to calculate their average orientation. There are several flavors of order parameters, most of which are related. The program `g_order` can calculate order parameters using the equation:

$$S_z = \frac{3}{2} \langle \cos^2 \theta_z \rangle - \frac{1}{2} \quad (8.36)$$

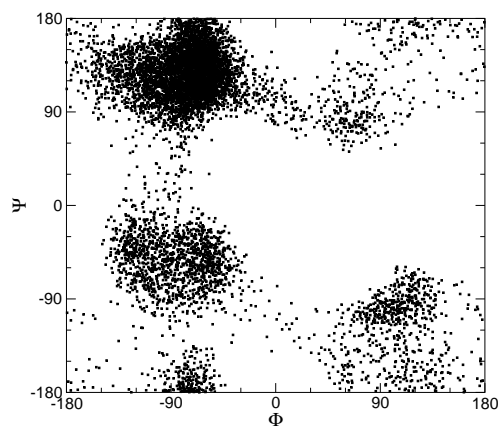

Figure 8.12: Ramachandran plot of a small protein.

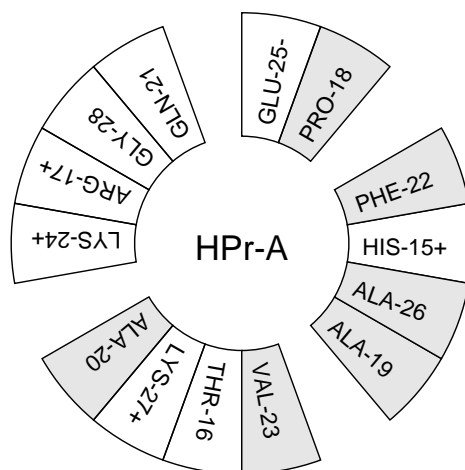

Figure 8.13: Helical wheel projection of the N-terminal helix of HPr.

where θ_z is the angle between the z -axis of the simulation box and the molecular axis under consideration. The latter is defined as the vector from C_{n-1} to C_{n+1} . The parameters S_x and S_y are defined in the same way. The brackets imply averaging over time and molecules. Order parameters can vary between 1 (full order along the interface normal) and $-1/2$ (full order perpendicular to the normal), with a value of zero in the case of isotropic orientation.

The program can do two things for you. It can calculate the order parameter for each CH_2 segment separately, for any of three axes, or it can divide the box in slices and calculate the average value of the order parameter per segment in one slice. The first method gives an idea of the ordering of a molecule from head to tail, the second method gives an idea of the ordering as function of the box length.

The electrostatic potential (ψ) across the interface can be computed from a trajectory by evaluating the double integral of the charge density ($\rho(z)$):

$$\psi(z) - \psi(-\infty) = - \int_{-\infty}^z dz' \int_{-\infty}^{z'} \rho(z'') dz'' / \epsilon_0 \quad (8.37)$$

where the position $z = -\infty$ is far enough in the bulk phase such that the field is zero. With this method, it is possible to “split” the total potential into separate contributions from lipid and water molecules. The program `g_potential` divides the box in slices and sums all charges of the atoms in each slice. It then integrates this charge density to give the electric field, which is in turn integrated to give the potential. Charge density, electric field, and potential are written to `xvgr` input files.

The program `g_traj` is a very simple analysis program. All it does is print the coordinates, velocities, or forces of selected atoms. It can also calculate the center of mass of one or more molecules and print the coordinates of the center of mass to three files. By itself, this is probably not a very useful analysis, but having the coordinates of selected molecules or atoms can be very handy for further analysis, not only in interfacial systems.

The program `g_density` also calculates the density of groups, but takes the masses into account and gives a plot of the density against a box axis. This is useful for looking at the distribution of groups or atoms across the interface.

8.15 Chemical shifts

`total, do_shift`

You can compute the NMR chemical shifts of protons with the program `do_shift`. This is just an GROMACS interface to the public domain program `total` [162]. For further information, read the article. Although there is limited support for this in GROMACS, users are encouraged to use the software provided by David Case’s group at Scripps because it seems to be more up-to-date.

Appendix A

Technical Details

A.1 Installation

The entire GROMACS package is Free Software, licensed under the GNU Lesser General Public License; either version 2.1 of the License, or (at your option) any later version. The main distribution site is our WWW server at www.gromacs.org.

The package is mainly distributed as source code, but others provide packages for Linux and Mac. Check your Linux distribution tools (search for gromacs). On Mac OS X the **port** tool will allow you to install a recent version. On the home page you will find all the information you need to install the package, mailing lists with archives, and several additional on-line resources like contributed topologies, etc.

A.2 Single or Double precision

GROMACS can be compiled in either single or double precision. It is very important to note here that single precision is actually mixed precision. Using single precision for all variables would lead to a significant reduction in accuracy. Although in single precision all state vectors, i.e. particle coordinates, velocities and forces, are stored in single precision, critical variables are double precision. A typical example of the latter is the virial, which is a sum over all forces in the system, which have varying signs. In addition, in many parts of the code we managed to avoid double precision for arithmetic, by paying attention to summation order or reorganization of mathematical expressions. The default choice is single precision, but it is easy to turn on double precision by adding the option `-DGMX_DOUBLE=on` to `cmake`. Double precision will be 20 to 100% slower than single precision depending on the architecture you are running on. Double precision will use somewhat more memory and run input, energy and full-precision trajectory files will be almost twice as large. SIMD (single-instruction multiple-data) intrinsics non-bonded force and/or energy kernels are available for x86 hardware in single and double precision in different SSE and AVX flavors; the minimum requirement is SSE2. IBM Blue Gene Q intrinsics will be available soon. Some other parts of the code, especially PME, also employ x86 SIMD intrinsics.

All other hardware will use optimized C kernels. The Verlet non-bonded scheme uses SIMD non-bonded kernels that are C pre-processor macro driven, therefore it is straightforward to implement SIMD acceleration for new architectures; a guide is provided on www.gromacs.org.

The energies in single precision are accurate up to the last decimal, the last one or two decimals of the forces are non-significant. The virial is less accurate than the forces, since the virial is only one order of magnitude larger than the size of each element in the sum over all atoms (sec. B.1). In most cases this is not really a problem, since the fluctuations in the virial can be two orders of magnitude larger than the average. Using cut-offs for the Coulomb interactions cause large errors in the energies, forces, and virial. Even when using a reaction-field or lattice sum method, the errors are larger than, or comparable to, the errors due to the single precision. Since MD is chaotic, trajectories with very similar starting conditions will diverge rapidly, the divergence is faster in single precision than in double precision.

For most simulations single precision is accurate enough. In some cases double precision is required to get reasonable results:

- normal mode analysis, for the conjugate gradient or l-bfgs minimization and the calculation and diagonalization of the Hessian
- long-term energy conservation, especially for large systems

A.3 Porting GROMACS

The GROMACS system is designed with portability as a major design goal. However there are a number of things we assume to be present on the system GROMACS is being ported on. We assume the following features:

1. A UNIX-like operating system (BSD 4.x or SYSTEM V rev.3 or higher) or UNIX-like libraries running under *e.g.* Cygwin
2. an ANSI C compiler

There are some additional features in the package that require extra stuff to be present, but it is checked for in the configuration script and you will be warned if anything important is missing.

That's the requirements for a single node system. If you want to compile GROMACS for running a single simulation across multiple nodes, you also need an MPI library (Message-Passing Interface) to perform the parallel communication. This is always shipped with supercomputers, and for workstations you can find links to free MPI implementations through the GROMACS homepage at www.gromacs.org.

A.4 Environment Variables

GROMACS programs may be influenced by the use of environment variables. First of all, the variables set in the `GMXRC` file are essential for running and compiling GROMACS. Some other

useful environment variables are listed in the following sections. Most environment variables function by being set in your shell to any non-NULL value. Specific requirements are described below if other values need to be set. You should consult the documentation for your shell for instructions on how to set environment variables in the current shell, or in config files for future shells. Note that requirements for exporting environment variables to jobs run under batch control systems vary and you should consult your local documentation for details.

Output Control

1. `GMX_CONSTRAINTVIR`: print constraint virial and force virial energy terms.
2. `GMX_MAXBACKUP`: GROMACS automatically backs up old copies of files when trying to write a new file of the same name, and this variable controls the maximum number of backups that will be made, default 99.
3. `GMX_NO_QUOTES`: if this is explicitly set, no cool quotes will be printed at the end of a program.
4. `GMX_SUPPRESS_DUMP`: prevent dumping of step files during (for example) blowing up during failure of constraint algorithms.
5. `GMX_TPI_DUMP`: dump all configurations to a `.pdb` file that have an interaction energy less than the value set in this environment variable.
6. `GMX_VIEW_XPM`: `GMX_VIEW_XVG`, `GMX_VIEW_EPS` and `GMX_VIEW_PDB`, commands used to automatically view `.xvg`, `.xpm`, `.eps` and `.pdb` file types, respectively; they default to `xv`, `xmgrace`, `ghostview` and `rasmol`. Set to empty to disable automatic viewing of a particular file type. The command will be forked off and run in the background at the same priority as the GROMACS tool (which might not be what you want). Be careful not to use a command which blocks the terminal (e.g. `vi`), since multiple instances might be run.
7. `GMX_VIRIAL_TEMPERATURE`: print virial temperature energy term
8. `LOG_BUFS`: the size of the buffer for file I/O. When set to 0, all file I/O will be unbuffered and therefore very slow. This can be handy for debugging purposes, because it ensures that all files are always totally up-to-date.
9. `LOGO`: set display color for logo in `ngmx`.
10. `LONGFORMAT`: use long float format when printing decimal values.

Debugging

1. `DUMPNL`: dump neighbor list. If set to a positive number the *entire* neighbor list is printed in the log file (may be many megabytes). Mainly for debugging purposes, but may also be handy for porting to other platforms.
2. `WHERE`: when set, print debugging info on line numbers.

Performance and Run Control

1. `DISTGCT`: couple distances between two atoms when doing general coupling theory processes. The format is a string containing two integers, separated by a space.
2. `GALACTIC_DYNAMICS`: planetary simulations are made possible (just for fun) by setting this environment variable, which allows setting `epsilon_r = -1` in the `.mdp` file. Normally, `epsilon_r` must be greater than zero to prevent a fatal error. See www.gromacs.org for example input files for a planetary simulation.
3. `GMX_ALLOW_CPT_MISMATCH`: when set, runs will not exit if the ensemble set in the `.tpr` file does not match that of the `.cpt` file.
4. `GMX_CAPACITY`: the maximum capacity of charge groups per processor when using particle decomposition.
5. `GMX_CUDA_NB_DEFAULT`: Force the use of the default CUDA non-bonded kernels instead of the legacy ones; mutually exclusive of `GMX_CUDA_NB_LEGACY`.
6. `GMX_CUDA_NB_EWALD_TWINCUT`: force the use of twin-range cutoff kernel even if `rvdw = rcoulomb` after PP-PME load balancing. The switch to twin-range kernels is automated, so this variable should be used only for benchmarking.
7. `GMX_CUDA_NB_LEGACY`: Force the use of the legacy CUDA non-bonded kernels, which are the default when using the CUDA toolkit versions 3.2 or 4.0 on Fermi NVIDIA GPUs (compute capability 2.x); mutually exclusive of `GMX_CUDA_NB_DEFAULT`.
8. `GMX_CUDA_STREAMSYNC`: force the use of `cudaStreamSynchronize` on ECC-enabled GPUs, which leads to performance loss due to a known CUDA driver bug present in API v5.0 NVIDIA drivers (pre-30x.xx). Cannot be set simultaneously with `GMX_NO_CUDA_STREAMSYNC`.
9. `GMX_CYCLE_ALL`: times all code during runs. Incompatible with threads.
10. `GMX_CYCLE_BARRIER`: calls `MPI_Barrier` before each cycle start/stop call.
11. `GMX_DD_ORDER_ZYX`: build domain decomposition cells in the order (z, y, x) rather than the default (x, y, z).
12. `GMX_DETAILED_PERF_STATS`: when set, print slightly more detailed performance information to the `.log` file. The resulting output is the way performance summary is reported in versions 4.5.x and thus may be useful for anyone using scripts to parse `.log` files or standard output.
13. `GMX_DISABLE_CPU_ACCELERATION`: disables CPU architecture-specific SIMD-optimized (SSE2, SSE4, AVX, etc.) non-bonded kernels thus forcing the use of plain C kernels.
14. `GMX_DISABLE_CUDA_TIMING`: timing of asynchronously executed GPU operations can have a non-negligible overhead with short step times. Disabling timing can improve performance in these cases.

15. `GMX_DISABLE_GPU_DETECTION`: when set, disables GPU detection even if `mdrun` was compiled with GPU support.
16. `GMX_DISABLE_PINHT`: disable pinning of consecutive threads to physical cores when using Intel hyperthreading. Controlled with `mdrun -nopinht` and thus this environment variable will likely be removed.
17. `GMX_DISRE_ENSEMBLE_SIZE`: the number of systems for distance restraint ensemble averaging. Takes an integer value.
18. `GMX_EMULATE_GPU`: emulate GPU runs by using algorithmically equivalent CPU reference code instead of GPU-accelerated functions. As the CPU code is slow, it is intended to be used only for debugging purposes. The behavior is automatically triggered if non-bonded calculations are turned off using `GMX_NO_NONBONDED` case in which the non-bonded calculations will not be called, but the CPU-GPU transfer will also be skipped.
19. `GMX_ENX_NO_FATAL`: disable exiting upon encountering a corrupted frame in an `.edr` file, allowing the use of all frames up until the corruption.
20. `GMX_FORCE_UPDATE`: update forces when invoking `mdrun -rerun`.
21. `GMX_GPU_ID`: set in the same way as the `mdrun` option `-gpu_id`, `GMX_GPU_ID` allows the user to specify different GPU id-s, which can be useful for selecting different devices on different compute nodes in a cluster. Cannot be used in conjunction with `-gpu_id`.
22. `GMX_IGNORE_FSYNC_FAILURE_ENV`: allow `mdrun` to continue even if a file is missing.
23. `GMX_LJCOMB_TOL`: when set to a floating-point value, overrides the default tolerance of $1e-5$ for force-field floating-point parameters.
24. `GMX_MAX_MPI_THREADS`: sets the maximum number of MPI-threads that `mdrun` can use.
25. `GMX_MAXCONSTRWARN`: if set to `-1`, `mdrun` will not exit if it produces too many LINCNS warnings.
26. `GMX_NB_GENERIC`: use the generic C kernel. Should be set if using the group-based cutoff scheme and also sets `GMX_NO_SOLV_OPT` to be true, thus disabling solvent optimizations as well.
27. `GMX_NB_MIN_CI`: neighbor list balancing parameter used when running on GPU. Sets the target minimum number pair-lists in order to improve multi-processor load-balance for better performance with small simulation systems. Must be set to a positive integer, the default value is optimized for NVIDIA Fermi and Kepler GPUs, therefore changing it is not necessary for normal usage, but it can be useful on future architectures.
28. `GMX_NBLISTCG`: use neighbor list and kernels based on charge groups.
29. `GMX_NBNXN_CYCLE`: when set, print detailed neighbor search cycle counting.

30. `GMX_NBNXN_EWALD_ANALYTICAL`: force the use of analytical Ewald non-bonded kernels, mutually exclusive of `GMX_NBNXN_EWALD_TABLE`.
31. `GMX_NBNXN_EWALD_TABLE`: force the use of tabulated Ewald non-bonded kernels, mutually exclusive of `GMX_NBNXN_EWALD_ANALYTICAL`.
32. `GMX_NBNXN_SIMD_2XNN`: force the use of $2x(N+N)$ SIMD CPU non-bonded kernels, mutually exclusive of `GMX_NBNXN_SIMD_4XN`.
33. `GMX_NBNXN_SIMD_4XN`: force the use of $4xN$ SIMD CPU non-bonded kernels, mutually exclusive of `GMX_NBNXN_SIMD_2XNN`.
34. `GMX_NO_ALLVSALL`: disables optimized all-vs-all kernels.
35. `GMX_NO_CART_REORDER`: used in initializing domain decomposition communicators. Node reordering is default, but can be switched off with this environment variable.
36. `GMX_NO_CUDA_STREAMSYNC`: the opposite of `GMX_CUDA_STREAMSYNC`. Disables the use of the standard `cudaStreamSynchronize`-based GPU waiting to improve performance when using CUDA driver API earlier than v5.0 with ECC-enabled GPUs.
37. `GMX_NO_INT`, `GMX_NO_TERM`, `GMX_NO_USR1`: disable signal handlers for `SIGINT`, `SIGTERM`, and `SIGUSR1`, respectively.
38. `GMX_NO_NODECOMM`: do not use separate inter- and intra-node communicators.
39. `GMX_NO_NONBONDED`: skip non-bonded calculations; can be used to estimate the possible performance gain from adding a GPU accelerator to the current hardware setup – assuming that this is fast enough to complete the non-bonded calculations while the CPU does bonded force and PME computation.
40. `GMX_NO_PULLVIR`: when set, do not add virial contribution to COM pull forces.
41. `GMX_NOCHARGEGROUPS`: disables multi-atom charge groups, *i.e.* each atom in all non-solvent molecules is assigned its own charge group.
42. `GMX_NOPREDICT`: shell positions are not predicted.
43. `GMX_NO_SOLV_OPT`: turns off solvent optimizations; automatic if `GMX_NB_GENERIC` is enabled.
44. `GMX_NSCELL_NCG`: the ideal number of charge groups per neighbor searching grid cell is hard-coded to a value of 10. Setting this environment variable to any other integer value overrides this hard-coded value.
45. `GMX_PME_NTHREADS`: set the number of OpenMP or PME threads (overrides the number guessed by `mdrun`).
46. `GMX_PME_P3M`: use P3M-optimized influence function instead of smooth PME B-spline interpolation.

47. `GMX_PME_THREAD_DIVISION`: PME thread division in the format “x y z” for all three dimensions. The sum of the threads in each dimension must equal the total number of PME threads (set in `GMX_PME_NTHREADS`).
48. `GMX_PMEONEDD`: if the number of domain decomposition cells is set to 1 for both x and y, decompose PME in one dimension.
49. `GMX_REQUIRE_SHELL_INIT`: require that shell positions are initiated.
50. `GMX_REQUIRE_TABLES`: require the use of tabulated Coulombic and van der Waals interactions.
51. `GMX_SCSIGMA_MIN`: the minimum value for soft-core σ . **Note** that this value is set using the `sc-sigma` keyword in the `.mdp` file, but this environment variable can be used to reproduce pre-4.5 behavior with respect to this parameter.
52. `GMX_TPIC_MASSES`: should contain multiple masses used for test particle insertion into a cavity. The center of mass of the last atoms is used for insertion into the cavity.
53. `GMX_USE_GRAPH`: use graph for bonded interactions.
54. `GMX_VERLET_BUFFER_RES`: resolution of buffer size in Verlet cutoff scheme. The default value is 0.001, but can be overridden with this environment variable.
55. `GMX_VERLET_SCHEME`: convert from group-based to Verlet cutoff scheme, even if the `cutoff_scheme` is not set to use Verlet in the `.mdp` file. It is unnecessary since the `-testverlet` option of `mdrun` has the same functionality, but it is maintained for backwards compatibility.
56. `GMXNPRI`: for SGI systems only. When set, gives the default non-degrading priority (npri) for `mdrun`, `g_covar` and `g_nmeig`, e.g. setting `setenv GMXNPRI 250` causes all runs to be performed at near-lowest priority by default.
57. `GMXNPRIALL`: same as `GMXNPRI`, but for all processes.
58. `MPIRUN`: the `mpirun` command used by `g_tune_pme`.
59. `MDRUN`: the `mdrun` command used by `g_tune_pme`.
60. `GMX_NSTLIST`: sets the default value for `nstlist`, preventing it from being tuned during `mdrun` startup when using the Verlet cutoff scheme.

Analysis and Core Functions

1. `ACC`: accuracy in Gaussian L510 (MC-SCF) component program.
2. `BASENAME`: prefix of `.tpr` files, used in Orca calculations for input and output file names.
3. `CPMCSCF`: when set to a nonzero value, Gaussian QM calculations will iteratively solve the CP-MCSCF equations.

4. `DEVEL_DIR`: location of modified links in Gaussian.
5. `DSSP`: used by `do_dssp` to point to the `dssp` executable (not just its path).
6. `GAUSS_DIR`: directory where Gaussian is installed.
7. `GAUSS_EXE`: name of the Gaussian executable.
8. `GKRWIDTH`: spacing used by `g_dipoles`.
9. `GMX_MAXRESRENUM`: sets the maximum number of residues to be renumbered by `grompp`. A value of -1 indicates all residues should be renumbered.
10. `GMX_FFRTTP_TER_RENAME`: Some force fields (like AMBER) use specific names for N- and C- terminal residues (NXXX and CXXX) as `.rtp` entries that are normally renamed. Setting this environment variable disables this renaming.
11. `GMX_PATH_GZIP`: `gunzip` executable, used by `g_wham`.
12. `GMXFONT`: name of X11 font used by `ngmx`.
13. `GMXTIMEUNIT`: the time unit used in output files, can be anything in fs, ps, ns, us, ms, s, m or h.
14. `MEM`: memory used for Gaussian QM calculation.
15. `MULTIPROT`: name of the `multirot` executable, used by the contributed program `do_multirot`.
16. `NCPUS`: number of CPUs to be used for Gaussian QM calculation
17. `OPENMM_PLUGIN_DIR`: the location of OpenMM plugins, needed for `mdrun-gpu`.
18. `ORCA_PATH`: directory where Orca is installed.
19. `SASTEP`: simulated annealing step size for Gaussian QM calculation.
20. `STATE`: defines state for Gaussian surface hopping calculation.
21. `TESTMC`: perform 1000 random swaps in Monte Carlo clustering method within `g_cluster`.
22. `TOTAL`: name of the `total` executable used by the contributed `do_shift` program.
23. `VERBOSE`: make `g_energy` and `eneconv` loud and noisy.
24. `VMD_PLUGIN_PATH`: where to find VMD plug-ins. Needed to be able to read file formats recognized only by a VMD plug-in.
25. `VMDDIR`: base path of VMD installation.
26. `XMGR`: sets viewer to `xmgr` (deprecated) instead of `xmgrace`.

A.5 Running GROMACS in parallel

By default GROMACS will be compiled with the built-in threaded MPI library. This library supports MPI communication between threads instead of between processes. To run GROMACS in parallel over multiple nodes in a cluster of a supercomputer, you need to configure and compile GROMACS with an external MPI library. All supercomputers are shipped with MPI libraries optimized for that particular platform, and if you are using a cluster of workstations there are several good free MPI implementations; Open MPI is usually a good choice. Once you have an MPI library installed it's trivial to compile GROMACS with MPI support: Just pass the option `-DGMX_MPI=on` to `cmake` and (re-)compile. Please see www.gromacs.org for more detailed instructions. Note that in addition to MPI parallelization, GROMACS supports thread-parallelization through OpenMP. MPI and OpenMP parallelization can be combined, which results in, so called, hybrid parallelization. See www.gromacs.org for details on use and performance of the parallelization schemes.

For communications over multiple nodes connected by a network, there is a program usually called `mpirun` with which you can start the parallel processes. A typical command line could look like:

```
mpirun -np 10 mdrun_mpi -s topol -v
```

With the implementation of threading available by default in GROMACS version 4.5, if you have a single machine with multiple processors you don't have to use the `mpirun` command, or compile with MPI. Instead, you can allow GROMACS to determine the number of threads automatically, or use the `mdrun` option `-nt:mdrun -nt 8 -s topol.tpr`

Check your local manuals (or online manual) for exact details of your MPI implementation.

If you are interested in programming MPI yourself, you can find manuals and reference literature on the internet.

A.6 Running GROMACS on GPUs

As of version 4.6, GROMACS has native GPU support through CUDA. Note that GROMACS only off-loads the most compute intensive parts to the GPU, currently the non-bonded interactions, and does all other parts of the MD calculation on the CPU. The requirements for the CUDA code are an Nvidia GPU with compute capability ≥ 2.0 , i.e. at least Fermi class. In many cases `cmake` can auto-detect GPUs and the support will be configured automatically. To be sure GPU support is configured, pass the `-DGMX_GPU=on` option to `cmake`. The actual use of GPUs is decided at run time by `mdrun`, depending on the availability of (suitable) GPUs and on the run input settings. A binary compiled with GPU support can also run CPU only simulations. Use `mdrun -nb cpu` to force a simulation to run on CPUs only. Only simulations with the Verlet cut-off scheme will run on a GPU. To test performance of old `tpr` files with GPUs, you can use the `-testverlet` option of `mdrun`, but as this doesn't do the full parameter consistency check of `grompp`, you should not use this option for production simulations. Getting good performance with GROMACS on GPUs is easy, but getting best performance can be difficult. Please check www.gromacs.org for up to date information on GPU usage.

Appendix B

Some implementation details

In this chapter we will present some implementation details. This is far from complete, but we deemed it necessary to clarify some things that would otherwise be hard to understand.

B.1 Single Sum Virial in GROMACS

The virial Ξ can be written in full tensor form as:

$$\Xi = -\frac{1}{2} \sum_{i < j}^N \mathbf{r}_{ij} \otimes \mathbf{F}_{ij} \quad (\text{B.1})$$

where \otimes denotes the *direct product* of two vectors.¹ When this is computed in the inner loop of an MD program 9 multiplications and 9 additions are needed.²

Here it is shown how it is possible to extract the virial calculation from the inner loop [163].

B.1.1 Virial

In a system with , the periodicity must be taken into account for the virial:

$$\Xi = -\frac{1}{2} \sum_{i < j}^N \mathbf{r}_{ij}^n \otimes \mathbf{F}_{ij} \quad (\text{B.2})$$

where \mathbf{r}_{ij}^n denotes the distance vector of the *nearest image* of atom i from atom j . In this definition we add a *shift vector* δ_i to the position vector \mathbf{r}_i of atom i . The difference vector \mathbf{r}_{ij}^n is thus equal to:

$$\mathbf{r}_{ij}^n = \mathbf{r}_i + \delta_i - \mathbf{r}_j \quad (\text{B.3})$$

or in shorthand:

$$\mathbf{r}_{ij}^n = \mathbf{r}_i^n - \mathbf{r}_j \quad (\text{B.4})$$

¹ $(\mathbf{u} \otimes \mathbf{v})^{\alpha\beta} = \mathbf{u}_\alpha \mathbf{v}_\beta$

²The calculation of Lennard-Jones and Coulomb forces is about 50 floating point operations.

In a triclinic system, there are 27 possible images of i ; when a truncated octahedron is used, there are 15 possible images.

B.1.2 Virial from non-bonded forces

Here the derivation for the single sum virial in the *non-bonded force* routine is given. $i \neq j$ in all formulae below.

$$\Xi = -\frac{1}{2} \sum_{i < j}^N \mathbf{r}_{ij}^n \otimes \mathbf{F}_{ij} \quad (\text{B.5})$$

$$= -\frac{1}{4} \sum_{i=1}^N \sum_{j=1}^N (\mathbf{r}_i + \delta_i - \mathbf{r}_j) \otimes \mathbf{F}_{ij} \quad (\text{B.6})$$

$$= -\frac{1}{4} \sum_{i=1}^N \sum_{j=1}^N (\mathbf{r}_i + \delta_i) \otimes \mathbf{F}_{ij} - \mathbf{r}_j \otimes \mathbf{F}_{ij} \quad (\text{B.7})$$

$$= -\frac{1}{4} \left(\sum_{i=1}^N \sum_{j=1}^N (\mathbf{r}_i + \delta_i) \otimes \mathbf{F}_{ij} - \sum_{i=1}^N \sum_{j=1}^N \mathbf{r}_j \otimes \mathbf{F}_{ij} \right) \quad (\text{B.8})$$

$$= -\frac{1}{4} \left(\sum_{i=1}^N (\mathbf{r}_i + \delta_i) \otimes \sum_{j=1}^N \mathbf{F}_{ij} - \sum_{j=1}^N \mathbf{r}_j \otimes \sum_{i=1}^N \mathbf{F}_{ij} \right) \quad (\text{B.9})$$

$$= -\frac{1}{4} \left(\sum_{i=1}^N (\mathbf{r}_i + \delta_i) \otimes \mathbf{F}_i + \sum_{j=1}^N \mathbf{r}_j \otimes \mathbf{F}_j \right) \quad (\text{B.10})$$

$$= -\frac{1}{4} \left(2 \sum_{i=1}^N \mathbf{r}_i \otimes \mathbf{F}_i + \sum_{i=1}^N \delta_i \otimes \mathbf{F}_i \right) \quad (\text{B.11})$$

In these formulae we introduced:

$$\mathbf{F}_i = \sum_{j=1}^N \mathbf{F}_{ij} \quad (\text{B.12})$$

$$\mathbf{F}_j = \sum_{i=1}^N \mathbf{F}_{ji} \quad (\text{B.13})$$

which is the total force on i with respect to j . Because we use Newton's Third Law:

$$\mathbf{F}_{ij} = -\mathbf{F}_{ji} \quad (\text{B.14})$$

we must, in the implementation, double the term containing the shift δ_i .

B.1.3 The intra-molecular shift (mol-shift)

For the bonded forces and SHAKE it is possible to make a *mol-shift* list, in which the periodicity is stored. We simply have an array `mshift` in which for each atom an index in the `shiftvec` array is stored.

The algorithm to generate such a list can be derived from graph theory, considering each particle in a molecule as a bead in a graph, the bonds as edges.

- 1 Represent the bonds and atoms as bidirectional graph
- 2 Make all atoms white
- 3 Make one of the white atoms black (atom i) and put it in the central box
- 4 Make all of the neighbors of i that are currently white, gray
- 5 Pick one of the gray atoms (atom j), give it the correct periodicity with respect to any of its black neighbors and make it black
- 6 Make all of the neighbors of j that are currently white, gray
- 7 If any gray atom remains, go to [5]
- 8 If any white atom remains, go to [3]

Using this algorithm we can

- optimize the bonded force calculation as well as SHAKE
- calculate the virial from the bonded forces in the single sum method again

Find a representation of the bonds as a bidirectional graph.

B.1.4 Virial from Covalent Bonds

Since the covalent bond force gives a contribution to the virial, we have:

$$b = \|\mathbf{r}_{ij}^n\| \quad (\text{B.15})$$

$$V_b = \frac{1}{2}k_b(b - b_0)^2 \quad (\text{B.16})$$

$$\mathbf{F}_i = -\nabla V_b \quad (\text{B.17})$$

$$= k_b(b - b_0) \frac{\mathbf{r}_{ij}^n}{b} \quad (\text{B.18})$$

$$\mathbf{F}_j = -\mathbf{F}_i \quad (\text{B.19})$$

The virial contribution from the bonds then is:

$$\Xi_b = -\frac{1}{2}(\mathbf{r}_i^n \otimes \mathbf{F}_i + \mathbf{r}_j \otimes \mathbf{F}_j) \quad (\text{B.20})$$

$$= -\frac{1}{2}\mathbf{r}_{ij}^n \otimes \mathbf{F}_i \quad (\text{B.21})$$

B.1.5 Virial from SHAKE

An important contribution to the virial comes from shake. Satisfying the constraints a force \mathbf{G} that is exerted on the particles “shaken.” If this force does not come out of the algorithm (as in standard SHAKE) it can be calculated afterward (when using *leap-frog*) by:

$$\Delta \mathbf{r}_i = \mathbf{r}_i(t + \Delta t) - [\mathbf{r}_i(t) + \mathbf{v}_i(t - \frac{\Delta t}{2})\Delta t + \frac{\mathbf{F}_i}{m_i}\Delta t^2] \quad (\text{B.22})$$

$$\mathbf{G}_i = \frac{m_i \Delta \mathbf{r}_i}{\Delta t^2} \quad (\text{B.23})$$

This does not help us in the general case. Only when no periodicity is needed (like in rigid water) this can be used, otherwise we must add the virial calculation in the inner loop of SHAKE.

When it *is* applicable the virial can be calculated in the single sum way:

$$\Xi = -\frac{1}{2} \sum_i^{N_c} \mathbf{r}_i \otimes \mathbf{F}_i \quad (\text{B.24})$$

where N_c is the number of constrained atoms.

B.2 Optimizations

Here we describe some of the algorithmic optimizations used in GROMACS, apart from parallelism. One of these, the implementation of the $1.0/\sqrt{x}$ function is treated separately in sec. B.3. The most important other optimizations are described below.

B.2.1 Inner Loops for Water

GROMACS uses special inner loops to calculate non-bonded interactions for water molecules with other atoms, and yet another set of loops for interactions between pairs of water molecules. There highly optimized loops for two types of water models. For three site models similar to SPC [80], *i.e.*:

1. There are three atoms in the molecule.
2. The whole molecule is a single charge group.
3. The first atom has Lennard-Jones (sec. 4.1.1) and Coulomb (sec. 4.1.3) interactions.
4. Atoms two and three have only Coulomb interactions, and equal charges.

These loops also works for the SPC/E [164] and TIP3P [104] water models. And for four site water models similar to TIP4P [104]:

1. There are four atoms in the molecule.
2. The whole molecule is a single charge group.

3. The first atom has only Lennard-Jones (sec. 4.1.1) interactions.
4. Atoms two and three have only Coulomb (sec. 4.1.3) interactions, and equal charges.
5. Atom four has only Coulomb interactions.

The benefit of these implementations is that there are more floating-point operations in a single loop, which implies that some compilers can schedule the code better. However, it turns out that even some of the most advanced compilers have problems with scheduling, implying that manual tweaking is necessary to get optimum performance. This may include common-sub-expression elimination, or moving code around.

B.2.2 Fortran Code

Unfortunately, on a few platforms Fortran compilers are still better than C-compilers. For some machines (*e.g.* SGI Power Challenge) the difference may be up to a factor of 3, in the case of vector computers this may be even larger. Therefore, some of the routines that take up a lot of computer time have been translated into Fortran and even assembly code for Intel and AMD x86 processors. In most cases, the Fortran or assembly loops should be selected automatically by the `configure` script when appropriate, but you can also tweak this by setting options to the `configure` script.

B.3 Computation of the 1.0/sqrt function

B.3.1 Introduction

The GROMACS project started with the development of a $1/\sqrt{x}$ processor that calculates:

$$Y(x) = \frac{1}{\sqrt{x}} \quad (\text{B.25})$$

As the project continued, the Intel i860 processor was used to implement GROMACS, which now turned into almost a full software project. The $1/\sqrt{x}$ processor was implemented using a Newton-Raphson iteration scheme for one step. For this it needed look-up tables to provide the initial approximation. The $1/\sqrt{x}$ function makes it possible to use two almost independent tables for the exponent seed and the fraction seed with the IEEE floating-point representation.

B.3.2 General

According to [165] the $1/\sqrt{x}$ function can be evaluated using the Newton-Raphson iteration scheme. The inverse function is:

$$X(y) = \frac{1}{y^2} \quad (\text{B.26})$$

So instead of calculating:

$$Y(a) = q \quad (\text{B.27})$$

the equation:

$$X(q) - a = 0 \quad (\text{B.28})$$

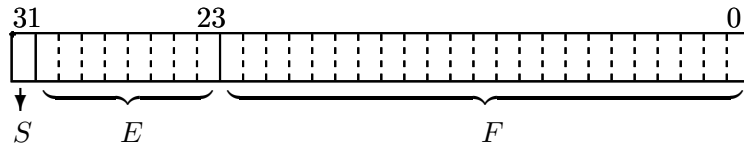

$$\text{Value} = (-1)^S (2^{E-127}) (1.F)$$

Figure B.1: IEEE single-precision floating-point format

can now be solved using Newton-Raphson. An iteration is performed by calculating:

$$y_{n+1} = y_n - \frac{f(y_n)}{f'(y_n)} \quad (\text{B.29})$$

The absolute error ε , in this approximation is defined by:

$$\varepsilon \equiv y_n - q \quad (\text{B.30})$$

Using Taylor series expansion to estimate the error results in:

$$\varepsilon_{n+1} = -\frac{\varepsilon_n^2 f''(y_n)}{2 f'(y_n)} \quad (\text{B.31})$$

according to [165] equation (3.2). This is an estimation of the absolute error.

B.3.3 Applied to floating-point numbers

Floating-point numbers in IEEE 32 bit single-precision format have a nearly constant relative error of $\Delta x/x = 2^{-24}$. As seen earlier in the Taylor series expansion equation (eqn. B.31), the error in every iteration step is absolute and in general dependent of y . If the error is expressed as a relative error ε_r the following holds:

$$\varepsilon_{r_{n+1}} \equiv \frac{\varepsilon_{n+1}}{y} \quad (\text{B.32})$$

and so:

$$\varepsilon_{r_{n+1}} = -\left(\frac{\varepsilon_n}{y}\right)^2 y \frac{f''}{2f'} \quad (\text{B.33})$$

For the function $f(y) = y^{-2}$ the term $y f''/2f'$ is constant (equal to $-3/2$) so the relative error ε_{r_n} is independent of y .

$$\varepsilon_{r_{n+1}} = \frac{3}{2} (\varepsilon_{r_n})^2 \quad (\text{B.34})$$

The conclusion of this is that the function $1/\sqrt{x}$ can be calculated with a specified accuracy.

B.3.4 Specification of the look-up table

To calculate the function $1/\sqrt{x}$ using the previously mentioned iteration scheme, it is clear that the first estimation of the solution must be accurate enough to get precise results. The requirements for the calculation are

- Maximum possible accuracy with the used IEEE format
- Use only one iteration step for maximum speed

The first requirement states that the result of $1/\sqrt{x}$ may have a relative error ε_r equal to the ε_r of a IEEE 32 bit single-precision floating-point number. From this, the $1/\sqrt{x}$ of the initial approximation can be derived, rewriting the definition of the relative error for succeeding steps (eqn. B.34):

$$\frac{\varepsilon_n}{y} = \sqrt{\varepsilon_{r_{n+1}} \frac{2f'}{yf''}} \quad (\text{B.35})$$

So for the look-up table the needed accuracy is:

$$\frac{\Delta Y}{Y} = \sqrt{\frac{2}{3} 2^{-24}} \quad (\text{B.36})$$

which defines the width of the table that must be ≥ 13 bit.

At this point the relative error, ε_{r_n} , of the look-up table is known. From this the maximum relative error in the argument can be calculated as follows. The absolute error Δx is defined as:

$$\Delta x \equiv \frac{\Delta Y}{Y'} \quad (\text{B.37})$$

and thus:

$$\frac{\Delta x}{Y} = \frac{\Delta Y}{Y} (Y')^{-1} \quad (\text{B.38})$$

and thus:

$$\Delta x = \text{constant} \frac{Y}{Y'} \quad (\text{B.39})$$

For the $1/\sqrt{x}$ function, $Y/Y' \sim x$ holds, so $\Delta x/x = \text{constant}$. This is a property of the used floating-point representation as earlier mentioned. The needed accuracy of the argument of the look-up table follows from:

$$\frac{\Delta x}{x} = -2 \frac{\Delta Y}{Y} \quad (\text{B.40})$$

So, using the floating-point accuracy (eqn. B.36):

$$\frac{\Delta x}{x} = -2 \sqrt{\frac{2}{3} 2^{-24}} \quad (\text{B.41})$$

This defines the length of the look-up table which should be ≥ 12 bit.

B.3.5 Separate exponent and fraction computation

The used IEEE 32 bit single-precision floating-point format specifies that a number is represented by a exponent and a fraction. The previous section specifies for every possible floating-point number the look-up table length and width. Only the size of the fraction of a floating-point number defines the accuracy. The conclusion from this can be that the size of the look-up table is length of look-up table, earlier specified, times the size of the exponent ($2^{12}2^8$, $1Mb$). The $1/\sqrt{x}$ function has the property that the exponent is independent of the fraction. This becomes clear if the floating-point representation is used. Define:

$$x \equiv (-1)^S (2^{E-127})(1.F) \quad (\text{B.42})$$

See Fig. B.1, where $0 \leq S \leq 1$, $0 \leq E \leq 255$, $1 \leq 1.F < 2$ and S, E, F integer (normalization conditions). The sign bit (S) can be omitted because $1/\sqrt{x}$ is only defined for $x > 0$. The $1/\sqrt{x}$ function applied to x results in:

$$y(x) = \frac{1}{\sqrt{x}} \quad (\text{B.43})$$

or:

$$y(x) = \frac{1}{\sqrt{(2^{E-127})(1.F)}} \quad (\text{B.44})$$

This can be rewritten as:

$$y(x) = (2^{E-127})^{-1/2} (1.F)^{-1/2} \quad (\text{B.45})$$

Define:

$$(2^{E'-127}) \equiv (2^{E-127})^{-1/2} \quad (\text{B.46})$$

$$1.F' \equiv (1.F)^{-1/2} \quad (\text{B.47})$$

Then $\frac{1}{\sqrt{2}} < 1.F' \leq 1$ holds, so the condition $1 \leq 1.F' < 2$, which is essential for normalized real representation, is not valid anymore. By introducing an extra term, this can be corrected. Rewrite the $1/\sqrt{x}$ function applied to floating-point numbers (eqn. B.45) as:

$$y(x) = (2^{\frac{127-E}{2}-1})(2(1.F)^{-1/2}) \quad (\text{B.48})$$

and:

$$(2^{E'-127}) \equiv (2^{\frac{127-E}{2}-1}) \quad (\text{B.49})$$

$$1.F' \equiv 2(1.F)^{-1/2} \quad (\text{B.50})$$

Then $\sqrt{2} < 1.F \leq 2$ holds. This is not the exact valid range as defined for normalized floating-point numbers in eqn. B.42. The value 2 causes the problem. By mapping this value on the nearest representation < 2 , this can be solved. The small error that is introduced by this approximation is within the allowable range.

The integer representation of the exponent is the next problem. Calculating $(2^{\frac{127-E}{2}-1})$ introduces a fractional result if $(127 - E) = \text{odd}$. This is again easily accounted for by splitting up the calculation into an odd and an even part. For $(127 - E) = \text{even}$ E' in equation (eqn. B.49) can be exactly calculated in integer arithmetic as a function of E .

$$E' = \frac{127 - E}{2} + 126 \quad (\text{B.51})$$

For $(127 - E) = \text{odd}$ equation (eqn. B.45) can be rewritten as:

$$y(x) = (2^{\frac{127-E-1}{2}}) \left(\frac{1.F}{2}\right)^{-1/2} \quad (\text{B.52})$$

Thus:

$$E' = \frac{126 - E}{2} + 127 \quad (\text{B.53})$$

which also can be calculated exactly in integer arithmetic. **Note** that the fraction is automatically corrected for its range earlier mentioned, so the exponent does not need an extra correction.

The conclusions from this are:

- The fraction and exponent look-up table are independent. The fraction look-up table exists of two tables (odd and even exponent) so the odd/even information of the exponent (lsb bit) has to be used to select the right table.
- The exponent table is an 256 x 8 bit table, initialized for *odd* and *even*.

B.3.6 Implementation

The look-up tables can be generated by a small C program, which uses floating-point numbers and operations with IEEE 32 bit single-precision format. Note that because of the *oddeven* information that is needed, the fraction table is twice the size earlier specified (13 bit i.s.o. 12 bit).

The function according to eqn. B.29 has to be implemented. Applied to the $1/\sqrt{x}$ function, equation eqn. B.28 leads to:

$$f = a - \frac{1}{y^2} \quad (\text{B.54})$$

and so:

$$f' = \frac{2}{y^3} \quad (\text{B.55})$$

so:

$$y_{n+1} = y_n - \frac{a - \frac{1}{y_n^2}}{\frac{2}{y_n^3}} \quad (\text{B.56})$$

or:

$$y_{n+1} = \frac{y_n}{2} (3 - ay_n^2) \quad (\text{B.57})$$

Where y_0 can be found in the look-up tables, and y_1 gives the result to the maximum accuracy. It is clear that only one iteration extra (in double precision) is needed for a double-precision result.

B.4 Modifying GROMACS

The following files have to be edited in case you want to add a bonded potential of any type.

1. `include/bondf.h`
2. `include/types/idef.h`

3. `include/types/nrn.h`
4. `include/types/enums.h`
5. `include/grompp.h`
6. `src/kernel/topdirs.c`
7. `src/gmxlib/tpxio.c`
8. `src/gmxlib/bondfree.c`
9. `src/gmxlib/ifunc.c`
10. `src/gmxlib/nrn.c`
11. `src/kernel/convparm.c`
12. `src/kernel/topdirs.c`
13. `src/kernel/topio.c`

Appendix C

Averages and fluctuations

C.1 Formulae for averaging

Note: this section was taken from ref [166].

When analyzing a MD trajectory averages $\langle x \rangle$ and fluctuations

$$\langle (\Delta x)^2 \rangle^{\frac{1}{2}} = \langle [x - \langle x \rangle]^2 \rangle^{\frac{1}{2}} \quad (\text{C.1})$$

of a quantity x are to be computed. The variance σ_x of a series of N_x values, $\{x_i\}$, can be computed from

$$\sigma_x = \sum_{i=1}^{N_x} x_i^2 - \frac{1}{N_x} \left(\sum_{i=1}^{N_x} x_i \right)^2 \quad (\text{C.2})$$

Unfortunately this formula is numerically not very accurate, especially when $\sigma_x^{\frac{1}{2}}$ is small compared to the values of x_i . The following (equivalent) expression is numerically more accurate

$$\sigma_x = \sum_{i=1}^{N_x} [x_i - \langle x \rangle]^2 \quad (\text{C.3})$$

with

$$\langle x \rangle = \frac{1}{N_x} \sum_{i=1}^{N_x} x_i \quad (\text{C.4})$$

Using eqns. C.2 and C.4 one has to go through the series of x_i values twice, once to determine $\langle x \rangle$ and again to compute σ_x , whereas eqn. C.1 requires only one sequential scan of the series $\{x_i\}$. However, one may cast eqn. C.2 in another form, containing partial sums, which allows for a sequential update algorithm. Define the partial sum

$$X_{n,m} = \sum_{i=n}^m x_i \quad (\text{C.5})$$

and the partial variance

$$\sigma_{n,m} = \sum_{i=n}^m \left[x_i - \frac{X_{n,m}}{m-n+1} \right]^2 \quad (\text{C.6})$$

It can be shown that

$$X_{n,m+k} = X_{n,m} + X_{m+1,m+k} \quad (\text{C.7})$$

and

$$\sigma_{n,m+k} = \sigma_{n,m} + \sigma_{m+1,m+k} + \left[\frac{X_{n,m}}{m-n+1} - \frac{X_{n,m+k}}{m+k-n+1} \right]^2 * \frac{(m-n+1)(m+k-n+1)}{k} \quad (\text{C.8})$$

For $n = 1$ one finds

$$\sigma_{1,m+k} = \sigma_{1,m} + \sigma_{m+1,m+k} + \left[\frac{X_{1,m}}{m} - \frac{X_{1,m+k}}{m+k} \right]^2 \frac{m(m+k)}{k} \quad (\text{C.9})$$

and for $n = 1$ and $k = 1$ (eqn. C.8) becomes

$$\sigma_{1,m+1} = \sigma_{1,m} + \left[\frac{X_{1,m}}{m} - \frac{X_{1,m+1}}{m+1} \right]^2 m(m+1) \quad (\text{C.10})$$

$$= \sigma_{1,m} + \frac{[X_{1,m} - mx_{m+1}]^2}{m(m+1)} \quad (\text{C.11})$$

where we have used the relation

$$X_{1,m+1} = X_{1,m} + x_{m+1} \quad (\text{C.12})$$

Using formulae (eqn. C.11) and (eqn. C.12) the average

$$\langle x \rangle = \frac{X_{1,N_x}}{N_x} \quad (\text{C.13})$$

and the fluctuation

$$\langle (\Delta x)^2 \rangle^{\frac{1}{2}} = \left[\frac{\sigma_{1,N_x}}{N_x} \right]^{\frac{1}{2}} \quad (\text{C.14})$$

can be obtained by one sweep through the data.

C.2 Implementation

In GROMACS the instantaneous energies $E(m)$ are stored in the energy file, along with the values of $\sigma_{1,m}$ and $X_{1,m}$. Although the steps are counted from 0, for the energy and fluctuations steps are counted from 1. This means that the equations presented here are the ones that are implemented. We give somewhat lengthy derivations in this section to simplify checking of code and equations later on.

C.2.1 Part of a Simulation

It is not uncommon to perform a simulation where the first part, *e.g.* 100 ps, is taken as equilibration. However, the averages and fluctuations as printed in the log file are computed over the whole simulation. The equilibration time, which is now part of the simulation, may in such a case invalidate the averages and fluctuations, because these numbers are now dominated by the initial drift towards equilibrium.

Using eqns. C.7 and C.8 the average and standard deviation over part of the trajectory can be computed as:

$$X_{m+1,m+k} = X_{1,m+k} - X_{1,m} \quad (\text{C.15})$$

$$\sigma_{m+1,m+k} = \sigma_{1,m+k} - \sigma_{1,m} - \left[\frac{X_{1,m}}{m} - \frac{X_{1,m+k}}{m+k} \right]^2 \frac{m(m+k)}{k} \quad (\text{C.16})$$

or, more generally (with $p \geq 1$ and $q \geq p$):

$$X_{p,q} = X_{1,q} - X_{1,p-1} \quad (\text{C.17})$$

$$\sigma_{p,q} = \sigma_{1,q} - \sigma_{1,p-1} - \left[\frac{X_{1,p-1}}{p-1} - \frac{X_{1,q}}{q} \right]^2 \frac{(p-1)q}{q-p+1} \quad (\text{C.18})$$

Note that implementation of this is not entirely trivial, since energies are not stored every time step of the simulation. We therefore have to construct $X_{1,p-1}$ and $\sigma_{1,p-1}$ from the information at time p using eqns. C.11 and C.12:

$$X_{1,p-1} = X_{1,p} - x_p \quad (\text{C.19})$$

$$\sigma_{1,p-1} = \sigma_{1,p} - \frac{[X_{1,p-1} - (p-1)x_p]^2}{(p-1)p} \quad (\text{C.20})$$

C.2.2 Combining two simulations

Another frequently occurring problem is, that the fluctuations of two simulations must be combined. Consider the following example: we have two simulations (A) of n and (B) of m steps, in which the second simulation is a continuation of the first. However, the second simulation starts numbering from 1 instead of from $n+1$. For the partial sum this is no problem, we have to add $X_{1,n}^A$ from run A:

$$X_{1,n+m}^{AB} = X_{1,n}^A + X_{1,m}^B \quad (\text{C.21})$$

When we want to compute the partial variance from the two components we have to make a correction $\Delta\sigma$:

$$\sigma_{1,n+m}^{AB} = \sigma_{1,n}^A + \sigma_{1,m}^B + \Delta\sigma \quad (\text{C.22})$$

if we define x_i^{AB} as the combined and renumbered set of data points we can write:

$$\sigma_{1,n+m}^{AB} = \sum_{i=1}^{n+m} \left[x_i^{AB} - \frac{X_{1,n+m}^{AB}}{n+m} \right]^2 \quad (\text{C.23})$$

and thus

$$\sum_{i=1}^{n+m} \left[x_i^{AB} - \frac{X_{1,n+m}^{AB}}{n+m} \right]^2 = \sum_{i=1}^n \left[x_i^A - \frac{X_{1,n}^A}{n} \right]^2 + \sum_{i=1}^m \left[x_i^B - \frac{X_{1,m}^B}{m} \right]^2 + \Delta\sigma \quad (\text{C.24})$$

or

$$\begin{aligned} & \sum_{i=1}^{n+m} \left[(x_i^{AB})^2 - 2x_i^{AB} \frac{X_{1,n+m}^{AB}}{n+m} + \left(\frac{X_{1,n+m}^{AB}}{n+m} \right)^2 \right] - \\ & \sum_{i=1}^n \left[(x_i^A)^2 - 2x_i^A \frac{X_{1,n}^A}{n} + \left(\frac{X_{1,n}^A}{n} \right)^2 \right] - \\ & \sum_{i=1}^m \left[(x_i^B)^2 - 2x_i^B \frac{X_{1,m}^B}{m} + \left(\frac{X_{1,m}^B}{m} \right)^2 \right] = \Delta\sigma \end{aligned} \quad (\text{C.25})$$

all the x_i^2 terms drop out, and the terms independent of the summation counter i can be simplified:

$$\begin{aligned} & \frac{(X_{1,n+m}^{AB})^2}{n+m} - \frac{(X_{1,n}^A)^2}{n} - \frac{(X_{1,m}^B)^2}{m} - \\ & 2 \frac{X_{1,n+m}^{AB}}{n+m} \sum_{i=1}^{n+m} x_i^{AB} + 2 \frac{X_{1,n}^A}{n} \sum_{i=1}^n x_i^A + 2 \frac{X_{1,m}^B}{m} \sum_{i=1}^m x_i^B = \Delta\sigma \end{aligned} \quad (\text{C.26})$$

we recognize the three partial sums on the second line and use eqn. C.21 to obtain:

$$\Delta\sigma = \frac{(mX_{1,n}^A - nX_{1,m}^B)^2}{nm(n+m)} \quad (\text{C.27})$$

if we check this by inserting $m = 1$ we get back eqn. C.11

C.2.3 Summing energy terms

The `g_energy` program can also sum energy terms into one, *e.g.* potential + kinetic = total. For the partial averages this is again easy if we have S energy components s :

$$X_{m,n}^S = \sum_{i=m}^n \sum_{s=1}^S x_i^s = \sum_{s=1}^S \sum_{i=m}^n x_i^s = \sum_{s=1}^S X_{m,n}^s \quad (\text{C.28})$$

For the fluctuations it is less trivial again, considering for example that the fluctuation in potential and kinetic energy should cancel. Nevertheless we can try the same approach as before by writing:

$$\sigma_{m,n}^S = \sum_{s=1}^S \sigma_{m,n}^s + \Delta\sigma \quad (\text{C.29})$$

if we fill in eqn. C.6:

$$\sum_{i=m}^n \left[\left(\sum_{s=1}^S x_i^s \right) - \frac{X_{m,n}^S}{m-n+1} \right]^2 = \sum_{s=1}^S \sum_{i=m}^n \left[(x_i^s) - \frac{X_{m,n}^s}{m-n+1} \right]^2 + \Delta\sigma \quad (\text{C.30})$$

which we can expand to:

$$\begin{aligned} & \sum_{i=m}^n \left[\sum_{s=1}^S (x_i^s)^2 + \left(\frac{X_{m,n}^S}{m-n+1} \right)^2 - 2 \left(\frac{X_{m,n}^S}{m-n+1} \sum_{s=1}^S x_i^s + \sum_{s=1}^S \sum_{s'=s+1}^S x_i^s x_i^{s'} \right) \right] \\ & - \sum_{s=1}^S \sum_{i=m}^n \left[(x_i^s)^2 - 2 \frac{X_{m,n}^s}{m-n+1} x_i^s + \left(\frac{X_{m,n}^s}{m-n+1} \right)^2 \right] = \Delta\sigma \end{aligned} \quad (\text{C.31})$$

the terms with $(x_i^s)^2$ cancel, so that we can simplify to:

$$\begin{aligned} & \frac{\left(X_{m,n}^S \right)^2}{m-n+1} - 2 \frac{X_{m,n}^S}{m-n+1} \sum_{i=m}^n \sum_{s=1}^S x_i^s - 2 \sum_{i=m}^n \sum_{s=1}^S \sum_{s'=s+1}^S x_i^s x_i^{s'} - \\ & \sum_{s=1}^S \sum_{i=m}^n \left[-2 \frac{X_{m,n}^s}{m-n+1} x_i^s + \left(\frac{X_{m,n}^s}{m-n+1} \right)^2 \right] = \Delta\sigma \end{aligned} \quad (\text{C.32})$$

or

$$- \frac{\left(X_{m,n}^S \right)^2}{m-n+1} - 2 \sum_{i=m}^n \sum_{s=1}^S \sum_{s'=s+1}^S x_i^s x_i^{s'} + \sum_{s=1}^S \frac{\left(X_{m,n}^s \right)^2}{m-n+1} = \Delta\sigma \quad (\text{C.33})$$

If we now expand the first term using eqn. C.28 we obtain:

$$- \frac{\left(\sum_{s=1}^S X_{m,n}^s \right)^2}{m-n+1} - 2 \sum_{i=m}^n \sum_{s=1}^S \sum_{s'=s+1}^S x_i^s x_i^{s'} + \sum_{s=1}^S \frac{\left(X_{m,n}^s \right)^2}{m-n+1} = \Delta\sigma \quad (\text{C.34})$$

which we can reformulate to:

$$- 2 \left[\sum_{s=1}^S \sum_{s'=s+1}^S X_{m,n}^s X_{m,n}^{s'} + \sum_{i=m}^n \sum_{s=1}^S \sum_{s'=s+1}^S x_i^s x_i^{s'} \right] = \Delta\sigma \quad (\text{C.35})$$

or

$$- 2 \left[\sum_{s=1}^S X_{m,n}^s \sum_{s'=s+1}^S X_{m,n}^{s'} + \sum_{s=1}^S \sum_{i=m}^n x_i^s \sum_{s'=s+1}^S x_i^{s'} \right] = \Delta\sigma \quad (\text{C.36})$$

which gives

$$- 2 \sum_{s=1}^S \left[X_{m,n}^s \sum_{s'=s+1}^S \sum_{i=m}^n x_i^{s'} + \sum_{i=m}^n x_i^s \sum_{s'=s+1}^S x_i^{s'} \right] = \Delta\sigma \quad (\text{C.37})$$

Since we need all data points i to evaluate this, in general this is not possible. We can then make an estimate of $\sigma_{m,n}^S$ using only the data points that are available using the left hand side of eqn. C.30. While the average can be computed using all time steps in the simulation, the accuracy of the fluctuations is thus limited by the frequency with which energies are saved. Since this can be easily done with a program such as xmgr this is not built-in in GROMACS.

Appendix D

Manual Pages

D.1 Standard options for GROMACS tools

GROMACS programs have some standard options, of which some are hidden by default:

Other options

-h	bool	no	Print help info and quit
-version	bool	no	Print version info and quit
-verb	int	0	[hidden] Level of verbosity for this program
-hidden	bool	yes	[hidden] Print hidden options
-quiet	bool	no	[hidden] Do not print help info
-man	enum	tex	[hidden] Write manual and quit: no, html, tex, nroff, ascii, completion, py, xml or wiki
-debug	int	0	[hidden] Write file with debug information, 1: short, 2: also x and f
-nice	int	0	Set the nicelevel

- If the configuration script found Motif or Lesstif on your system, you can use the graphical interface (if not, you will get an error):
-X gmx.bool no Use dialog box GUI to edit command line options
- When compiled on an SGI-IRIX system, all GROMACS programs have an additional option:
-npri int 0 Set non blocking priority (try 128)
- Optional files are not used unless the option is set, in contrast to non-optional files, where the default file name is used when the option is not set.
- All GROMACS programs will accept file options without a file extension or filename being specified. In such cases the default filenames will be used. With multiple input file types, such as generic structure format, the directory will be searched for files of each type with the supplied or default name. When no such file is found, or with output files the first file type will be used.
- All GROMACS programs with the exception of `mdrun` and `eneconv` check if the command line options are valid. If this is not the case, the program will be halted.
- Enumerated options (enum) should be used with one of the arguments listed in the option description, the argument may be abbreviated. The first match to the shortest argument in the list will be selected.
- Vector options can be used with 1 or 3 parameters. When only one parameter is supplied the two others are also set to this value.

- All GROMACS programs can read compressed or g-zipped files. There might be a problem with reading compressed `.xtc`, `.trr` and `.trj` files, but these will not compress very well anyway.
- Most GROMACS programs can process a trajectory with fewer atoms than the run input or structure file, but only if the trajectory consists of the first `n` atoms of the run input or structure file.
- Many GROMACS programs will accept the `-tu` option to set the time units to use in output files (e.g. for `xmgr` graphs or `xpm` matrices) and in all time options.

D.2 do_dssp

`do_dssp` reads a trajectory file and computes the secondary structure for each time frame calling the `dssp` program. If you do not have the `dssp` program, get it from <http://swift.cmbi.ru.nl/gv/dssp>. `do_dssp` assumes that the `dssp` executable is located in `/usr/local/bin/dssp`. If this is not the case, then you should set an environment variable `DSSP` pointing to the `dssp` executable, e.g.:

```
setenv DSSP /opt/dssp/bin/dssp
```

Since version 2.0.0, `dssp` is invoked with a syntax that differs from earlier versions. If you have an older version of `dssp`, use the `-ver` option to direct `do_dssp` to use the older syntax. By default, `do_dssp` uses the syntax introduced with version 2.0.0. Even newer versions (which at the time of writing are not yet released) are assumed to have the same syntax as 2.0.0.

The structure assignment for each residue and time is written to an `.xpm` matrix file. This file can be visualized with for instance `xv` and can be converted to postscript with `xpm2ps`. Individual chains are separated by light grey lines in the `.xpm` and postscript files. The number of residues with each secondary structure type and the total secondary structure (`-sss`) count as a function of time are also written to file (`-sc`).

Solvent accessible surface (SAS) per residue can be calculated, both in absolute values (A^2) and in fractions of the maximal accessible surface of a residue. The maximal accessible surface is defined as the accessible surface of a residue in a chain of glycines. **Note** that the program `g_sas` can also compute SAS and that is more efficient.

Finally, this program can dump the secondary structure in a special file `ssdump.dat` for usage in the program `g_chi`. Together these two programs can be used to analyze dihedral properties as a function of secondary structure type.

Files

<code>-f</code>	<code>traj.xtc</code>	Input	Trajectory: <code>xtc trr trj gro g96 pdb cpt</code>
<code>-s</code>	<code>topol.tpr</code>	Input	Structure+mass(db): <code>tpr tpb tpa gro g96 pdb</code>
<code>-n</code>	<code>index.ndx</code>	Input, Opt.	Index file
<code>-ssdump</code>	<code>ssdump.dat</code>	Output, Opt.	Generic data file
<code>-map</code>	<code>ss.map</code>	Input, Lib.	File that maps matrix data to colors
<code>-o</code>	<code>ss.xpm</code>	Output	X PixMap compatible matrix file
<code>-sc</code>	<code>scount.svg</code>	Output	xvgr/xmgr file
<code>-a</code>	<code>area.xpm</code>	Output, Opt.	X PixMap compatible matrix file
<code>-ta</code>	<code>totarea.svg</code>	Output, Opt.	xvgr/xmgr file
<code>-aa</code>	<code>averarea.svg</code>	Output, Opt.	xvgr/xmgr file

Other options

<code>-h</code>	bool	no	Print help info and quit
<code>-version</code>	bool	no	Print version info and quit
<code>-nice</code>	int	19	Set the nicelevel
<code>-b</code>	time	0	First frame (ps) to read from trajectory
<code>-e</code>	time	0	Last frame (ps) to read from trajectory

-dt	time	0	Only use frame when $t \text{ MOD } dt = \text{first time (ps)}$
-tu	enum	ps	Time unit: fs, ps, ns, us, ms or s
-w	bool	no	View output .xvg, .xpm, .eps and .pdb files
-xvg	enum	xmgrace	xvg plot formatting: xmgrace, xmgr or none
-sss	string	HEBT	Secondary structures for structure count
-ver	int	2	DSSP major version. Syntax changed with version 2

D.3 editconf

editconf converts generic structure format to .gro, .g96 or .pdb.

The box can be modified with options `-box`, `-d` and `-angles`. Both `-box` and `-d` will center the system in the box, unless `-noc` is used.

Option `-bt` determines the box type: `triclinic` is a triclinic box, `cubic` is a rectangular box with all sides equal `dodecahedron` represents a rhombic dodecahedron and `octahedron` is a truncated octahedron. The last two are special cases of a triclinic box. The length of the three box vectors of the truncated octahedron is the shortest distance between two opposite hexagons. Relative to a cubic box with some periodic image distance, the volume of a dodecahedron with this same periodic distance is 0.71 times that of the cube, and that of a truncated octahedron is 0.77 times.

Option `-box` requires only one value for a cubic, rhombic dodecahedral, or truncated octahedral box.

With `-d` and a `triclinic` box the size of the system in the x -, y -, and z -directions is used. With `-d` and `cubic`, `dodecahedron` or `octahedron` boxes, the dimensions are set to the diameter of the system (largest distance between atoms) plus twice the specified distance.

Option `-angles` is only meaningful with option `-box` and a triclinic box and cannot be used with option `-d`.

When `-n` or `-ndef` is set, a group can be selected for calculating the size and the geometric center, otherwise the whole system is used.

`-rotate` rotates the coordinates and velocities.

`-princ` aligns the principal axes of the system along the coordinate axes, with the longest axis aligned with the x -axis. This may allow you to decrease the box volume, but beware that molecules can rotate significantly in a nanosecond.

Scaling is applied before any of the other operations are performed. Boxes and coordinates can be scaled to give a certain density (option `-density`). Note that this may be inaccurate in case a .gro file is given as input. A special feature of the scaling option is that when the factor -1 is given in one dimension, one obtains a mirror image, mirrored in one of the planes. When one uses -1 in three dimensions, a point-mirror image is obtained.

Groups are selected after all operations have been applied.

Periodicity can be removed in a crude manner. It is important that the box vectors at the bottom of your input file are correct when the periodicity is to be removed.

When writing .pdb files, B-factors can be added with the `-bf` option. B-factors are read from a file with following format: first line states number of entries in the file, next lines state an index followed by a B-factor. The B-factors will be attached per residue unless an index is larger than the number of residues or unless the `-atom` option is set. Obviously, any type of numeric data can be added instead of B-factors. `-legend` will produce a row of CA atoms with B-factors ranging from the minimum to the maximum value found, effectively making a legend for viewing.

With the option `-mead` a special .pdb (.pqr) file for the MEAD electrostatics program (Poisson-Boltzmann

solver) can be made. A further prerequisite is that the input file is a run input file. The B-factor field is then filled with the Van der Waals radius of the atoms while the occupancy field will hold the charge.

The option `-grasp` is similar, but it puts the charges in the B-factor and the radius in the occupancy.

Option `-align` allows alignment of the principal axis of a specified group against the given vector, with an optional center of rotation specified by `-aligncenter`.

Finally, with option `-label`, `editconf` can add a chain identifier to a `.pdb` file, which can be useful for analysis with e.g. Rasmol.

To convert a truncated octahedron file produced by a package which uses a cubic box with the corners cut off (such as GROMOS), use:

```
editconf -f in -rotate 0 45 35.264 -bt o -box veclen -o out
```

where `veclen` is the size of the cubic box times $\sqrt{3}/2$.

Files

<code>-f</code>	<code>conf.gro</code>	Input	Structure file: <code>gro g96 pdb tpr</code> etc.
<code>-n</code>	<code>index.ndx</code>	Input, Opt.	Index file
<code>-o</code>	<code>out.gro</code>	Output, Opt.	Structure file: <code>gro g96 pdb</code> etc.
<code>-mead</code>	<code>mead.pqr</code>	Output, Opt.	Coordinate file for MEAD
<code>-bf</code>	<code>bfact.dat</code>	Input, Opt.	Generic data file

Other options

<code>-h</code>	bool	no	Print help info and quit
<code>-version</code>	bool	no	Print version info and quit
<code>-nice</code>	int	0	Set the nicelevel
<code>-w</code>	bool	no	View output <code>.xvg</code> , <code>.xpm</code> , <code>.eps</code> and <code>.pdb</code> files
<code>-ndef</code>	bool	no	Choose output from default index groups
<code>-bt</code>	enum		
		<code>triclinic</code>	Box type for <code>-box</code> and <code>-d</code> : <code>triclinic</code> , <code>cubic</code> , <code>dodecahedron</code> or <code>octahedron</code>
<code>-box</code>	vector	0 0 0	Box vector lengths (a,b,c)
<code>-angles</code>	vector	90 90 90	Angles between the box vectors (bc,ac,ab)
<code>-d</code>	real	0	Distance between the solute and the box
<code>-c</code>	bool	no	Center molecule in box (implied by <code>-box</code> and <code>-d</code>)
<code>-center</code>	vector	0 0 0	Coordinates of geometrical center
<code>-aligncenter</code>	vector	0 0 0	Center of rotation for alignment
<code>-align</code>	vector	0 0 0	Align to target vector
<code>-translate</code>	vector	0 0 0	Translation
<code>-rotate</code>	vector	0 0 0	Rotation around the X, Y and Z axes in degrees
<code>-princ</code>	bool	no	Orient molecule(s) along their principal axes
<code>-scale</code>	vector	1 1 1	Scaling factor
<code>-density</code>	real	1000	Density (g/L) of the output box achieved by scaling
<code>-pbc</code>	bool	no	Remove the periodicity (make molecule whole again)
<code>-resnr</code>	int	-1	Renumber residues starting from <code>resnr</code>
<code>-grasp</code>	bool	no	Store the charge of the atom in the B-factor field and the radius of the atom in the occupancy field
<code>-rvdw</code>	real	0.12	Default Van der Waals radius (in nm) if one can not be found in the database or if no parameters are present in the topology file
<code>-sig56</code>	bool	no	Use $r_{min}/2$ (minimum in the Van der Waals potential) rather than $\sigma/2$
<code>-vdwread</code>	bool	no	Read the Van der Waals radii from the file <code>vdwradii.dat</code> rather than computing the radii based on the force field
<code>-atom</code>	bool	no	Force B-factor attachment per atom
<code>-legend</code>	bool	no	Make B-factor legend
<code>-label</code>	string	A	Add chain label for all residues

`-conect` bool no Add CONECT records to a `.pdb` file when written. Can only be done when a topology is present

- For complex molecules, the periodicity removal routine may break down, in that case you can use `trjconv`.

D.4 *eneconv*

With *multiple files* specified for the `-f` option:

Concatenates several energy files in sorted order. In the case of double time frames, the one in the later file is used. By specifying `-settime` you will be asked for the start time of each file. The input files are taken from the command line, such that the command `eneconv -f *.edr -o fixed.edr` should do the trick.

With *one file* specified for `-f`:

Reads one energy file and writes another, applying the `-dt`, `-offset`, `-t0` and `-settime` options and converting to a different format if necessary (indicated by file extensions).

`-settime` is applied first, then `-dt/-offset` followed by `-b` and `-e` to select which frames to write.

Files

<code>-f</code>	<code>ener.edr</code>	Input, Mult.	Energy file
<code>-o</code>	<code>fixed.edr</code>	Output	Energy file

Other options

<code>-h</code>	bool	no	Print help info and quit
<code>-version</code>	bool	no	Print version info and quit
<code>-nice</code>	int	19	Set the nicelevel
<code>-b</code>	real	-1	First time to use
<code>-e</code>	real	-1	Last time to use
<code>-dt</code>	real	0	Only write out frame when $t \text{ MOD } dt = \text{offset}$
<code>-offset</code>	real	0	Time offset for <code>-dt</code> option
<code>-settime</code>	bool	no	Change starting time interactively
<code>-sort</code>	bool	yes	Sort energy files (not frames)
<code>-rmdh</code>	bool	no	Remove free energy block data
<code>-scalefac</code>	real	1	Multiply energy component by this factor
<code>-error</code>	bool	yes	Stop on errors in the file

- When combining trajectories the sigma and E^2 (necessary for statistics) are not updated correctly. Only the actual energy is correct. One thus has to compute statistics in another way.

D.5 *g_anadock*

`g_anadock` analyses the results of an Autodock run and clusters the structures together, based on distance or RMSD. The docked energy and free energy estimates are analysed, and for each cluster the energy statistics are printed.

An alternative approach to this is to cluster the structures first using `g_cluster` and then sort the clusters on either lowest energy or average energy.

Files

-f	eiwit.pdb	Input	Protein data bank file
-ox	cluster.pdb	Output	Protein data bank file
-od	edocked.xvg	Output	xvgr/xmgr file
-of	efree.xvg	Output	xvgr/xmgr file
-g	anadock.log	Output	Log file

Other options

-h	bool	no	Print help info and quit
-version	bool	no	Print version info and quit
-nice	int	0	Set the nicelevel
-xvg	enum	xmgrace	xvg plot formatting: xmgrace, xmgr or none
-free	bool	no	Use Free energy estimate from autodock for sorting the classes
-rms	bool	yes	Cluster on RMS or distance
-cutoff	real	0.2	Maximum RMSD/distance for belonging to the same cluster

D.6 g_anaeig

`g_anaeig` analyzes eigenvectors. The eigenvectors can be of a covariance matrix (`g_covar`) or of a Normal Modes analysis (`g_nmeig`).

When a trajectory is projected on eigenvectors, all structures are fitted to the structure in the eigenvector file, if present, otherwise to the structure in the structure file. When no run input file is supplied, periodicity will not be taken into account. Most analyses are performed on eigenvectors `-first` to `-last`, but when `-first` is set to `-1` you will be prompted for a selection.

`-comp`: plot the vector components per atom of eigenvectors `-first` to `-last`.

`-rmsf`: plot the RMS fluctuation per atom of eigenvectors `-first` to `-last` (requires `-eig`).

`-proj`: calculate projections of a trajectory on eigenvectors `-first` to `-last`. The projections of a trajectory on the eigenvectors of its covariance matrix are called principal components (pc's). It is often useful to check the cosine content of the pc's, since the pc's of random diffusion are cosines with the number of periods equal to half the pc index. The cosine content of the pc's can be calculated with the program `g_analyze`.

`-2d`: calculate a 2d projection of a trajectory on eigenvectors `-first` and `-last`.

`-3d`: calculate a 3d projection of a trajectory on the first three selected eigenvectors.

`-filt`: filter the trajectory to show only the motion along eigenvectors `-first` to `-last`.

`-extr`: calculate the two extreme projections along a trajectory on the average structure and interpolate `-nframes` frames between them, or set your own extremes with `-max`. The eigenvector `-first` will be written unless `-first` and `-last` have been set explicitly, in which case all eigenvectors will be written to separate files. Chain identifiers will be added when writing a `.pdb` file with two or three structures (you can use `rasmol -nmrpdb` to view such a `.pdb` file).

Overlap calculations between covariance analysis:

Note: the analysis should use the same fitting structure

`-over`: calculate the subspace overlap of the eigenvectors in file `-v2` with eigenvectors `-first` to `-last` in file `-v`.

`-inpr`: calculate a matrix of inner-products between eigenvectors in files `-v` and `-v2`. All eigenvectors of both files will be used unless `-first` and `-last` have been set explicitly.

When `-v`, `-eig`, `-v2` and `-eig2` are given, a single number for the overlap between the covariance matrices is generated. The formulas are:

$$\text{difference} = \sqrt{\text{tr}((\sqrt{M1} - \sqrt{M2})^2)}$$

$$\text{normalized overlap} = 1 - \text{difference}/\sqrt{\text{tr}(M1) + \text{tr}(M2)}$$

$$\text{shape overlap} = 1 - \sqrt{\text{tr}((\sqrt{M1/\text{tr}(M1)} - \sqrt{M2/\text{tr}(M2)})^2)}$$

where $M1$ and $M2$ are the two covariance matrices and tr is the trace of a matrix. The numbers are proportional to the overlap of the square root of the fluctuations. The normalized overlap is the most useful number, it is 1 for identical matrices and 0 when the sampled subspaces are orthogonal.

When the `-entropy` flag is given an entropy estimate will be computed based on the Quasiharmonic approach and based on Schlitter's formula.

Files

<code>-v</code>	<code>eigenvec.trr</code>	Input	Full precision trajectory: trr trj cpt
<code>-v2</code>	<code>eigenvec2.trr</code>	Input, Opt.	Full precision trajectory: trr trj cpt
<code>-f</code>	<code>traj.xtc</code>	Input, Opt.	Trajectory: xtc trr trj gro g96 pdb cpt
<code>-s</code>	<code>topol.tpr</code>	Input, Opt.	Structure+mass(db): tpr tpb tpa gro g96 pdb
<code>-n</code>	<code>index.ndx</code>	Input, Opt.	Index file
<code>-eig</code>	<code>eigenval.xvg</code>	Input, Opt.	xvgr/xmgr file
<code>-eig2</code>	<code>eigenval2.xvg</code>	Input, Opt.	xvgr/xmgr file
<code>-comp</code>	<code>eigcomp.xvg</code>	Output, Opt.	xvgr/xmgr file
<code>-rmsf</code>	<code>eigrmsf.xvg</code>	Output, Opt.	xvgr/xmgr file
<code>-proj</code>	<code>proj.xvg</code>	Output, Opt.	xvgr/xmgr file
<code>-2d</code>	<code>2dproj.xvg</code>	Output, Opt.	xvgr/xmgr file
<code>-3d</code>	<code>3dproj.pdb</code>	Output, Opt.	Structure file: gro g96 pdb etc.
<code>-filt</code>	<code>filtered.xtc</code>	Output, Opt.	Trajectory: xtc trr trj gro g96 pdb cpt
<code>-extr</code>	<code>extreme.pdb</code>	Output, Opt.	Trajectory: xtc trr trj gro g96 pdb cpt
<code>-over</code>	<code>overlap.xvg</code>	Output, Opt.	xvgr/xmgr file
<code>-inpr</code>	<code>inprod.xpm</code>	Output, Opt.	X PixMap compatible matrix file

Other options

<code>-h</code>	bool	no	Print help info and quit
<code>-version</code>	bool	no	Print version info and quit
<code>-nice</code>	int	19	Set the nicelevel
<code>-b</code>	time	0	First frame (ps) to read from trajectory
<code>-e</code>	time	0	Last frame (ps) to read from trajectory
<code>-dt</code>	time	0	Only use frame when $t \text{ MOD } dt = \text{first time (ps)}$
<code>-tu</code>	enum	ps	Time unit: fs, ps, ns, us, ms or s
<code>-w</code>	bool	no	View output .xvg, .xpm, .eps and .pdb files
<code>-xvg</code>	enum	xmgrace	xvg plot formatting: xmgrace, xmgr or none
<code>-first</code>	int	1	First eigenvector for analysis (-1 is select)
<code>-last</code>	int	-1	Last eigenvector for analysis (-1 is till the last)
<code>-skip</code>	int	1	Only analyse every nr-th frame
<code>-max</code>	real	0	Maximum for projection of the eigenvector on the average structure, max=0 gives the extremes
<code>-nframes</code>	int	2	Number of frames for the extremes output
<code>-split</code>	bool	no	Split eigenvector projections where time is zero
<code>-entropy</code>	bool	no	Compute entropy according to the Quasiharmonic formula or Schlitter's method.
<code>-temp</code>	real	298.15	Temperature for entropy calculations
<code>-nevskip</code>	int	6	Number of eigenvalues to skip when computing the entropy due to the quasi harmonic approximation. When you do a rotational and/or translational fit prior to the covariance analysis, you get 3 or 6 eigenvalues that are very close to zero, and which should not be taken into account when computing the entropy.

D.7 g_analyze

`g_analyze` reads an ASCII file and analyzes data sets. A line in the input file may start with a time (see option `-time`) and any number of y -values may follow. Multiple sets can also be read when they are separated by `&` (option `-n`); in this case only one y -value is read from each line. All lines starting with `#` and `@` are skipped. All analyses can also be done for the derivative of a set (option `-d`).

All options, except for `-av` and `-power`, assume that the points are equidistant in time.

`g_analyze` always shows the average and standard deviation of each set, as well as the relative deviation of the third and fourth cumulant from those of a Gaussian distribution with the same standard deviation.

Option `-ac` produces the autocorrelation function(s). Be sure that the time interval between data points is much shorter than the time scale of the autocorrelation.

Option `-cc` plots the resemblance of set i with a cosine of $i/2$ periods. The formula is:

$$2(\int_0^T y(t) \cos(i\pi t) dt)^2 / \int_0^T y^2(t) dt$$

This is useful for principal components obtained from covariance analysis, since the principal components of random diffusion are pure cosines.

Option `-msd` produces the mean square displacement(s).

Option `-dist` produces distribution plot(s).

Option `-av` produces the average over the sets. Error bars can be added with the option `-errbar`. The errorbars can represent the standard deviation, the error (assuming the points are independent) or the interval containing 90% of the points, by discarding 5% of the points at the top and the bottom.

Option `-ee` produces error estimates using block averaging. A set is divided in a number of blocks and averages are calculated for each block. The error for the total average is calculated from the variance between averages of the m blocks B_i as follows: $\text{error}^2 = \sum (B_i - \langle B \rangle)^2 / (m*(m-1))$. These errors are plotted as a function of the block size. Also an analytical block average curve is plotted, assuming that the autocorrelation is a sum of two exponentials. The analytical curve for the block average is:

$$f(t) = \sigma \sqrt{2/T} (\alpha \tau_1 ((\exp(-t/\tau_1) - 1)\tau_1/t + 1) + (1 - \alpha)(\tau_2 ((\exp(-t/\tau_2) - 1)\tau_2/t + 1))),$$

where T is the total time. α , τ_1 and τ_2 are obtained by fitting $f^2(t)$ to error^2 . When the actual block average is very close to the analytical curve, the error is $\sigma \sqrt{2/T} (a\tau_1 + (1 - a)\tau_2)$. The complete derivation is given in B. Hess, J. Chem. Phys. 116:209-217, 2002.

Option `-bal` finds and subtracts the ultrafast "ballistic" component from a hydrogen bond autocorrelation function by the fitting of a sum of exponentials, as described in e.g. O. Markovitch, J. Chem. Phys. 129:084505, 2008. The fastest term is the one with the most negative coefficient in the exponential, or with `-d`, the one with most negative time derivative at time 0. `-nbalexp` sets the number of exponentials to fit.

Option `-gem` fits bimolecular rate constants k_a and k_b (and optionally k_D) to the hydrogen bond autocorrelation function according to the reversible geminate recombination model. Removal of the ballistic component first is strongly advised. The model is presented in O. Markovitch, J. Chem. Phys. 129:084505, 2008.

Option `-filter` prints the RMS high-frequency fluctuation of each set and over all sets with respect to a filtered average. The filter is proportional to $\cos(\pi t/\text{len})$ where t goes from $-\text{len}/2$ to $\text{len}/2$. len is supplied with the option `-filter`. This filter reduces oscillations with period $\text{len}/2$ and len by a factor of 0.79 and 0.33 respectively.

Option `-g` fits the data to the function given with option `-fitfn`.

Option `-power` fits the data to bt^a , which is accomplished by fitting to $at + b$ on log-log scale. All points after the first zero or with a negative value are ignored.

Option `-luzar` performs a Luzar & Chandler kinetics analysis on output from `g_hbond`. The input file can be taken directly from `g_hbond -ac`, and then the same result should be produced.

Files

<code>-f</code>	<code>graph.svg</code>	Input	xvgr/xmgr file
<code>-ac</code>	<code>autocorr.svg</code>	Output, Opt.	xvgr/xmgr file
<code>-msd</code>	<code>msd.svg</code>	Output, Opt.	xvgr/xmgr file
<code>-cc</code>	<code>coscont.svg</code>	Output, Opt.	xvgr/xmgr file
<code>-dist</code>	<code>distr.svg</code>	Output, Opt.	xvgr/xmgr file
<code>-av</code>	<code>average.svg</code>	Output, Opt.	xvgr/xmgr file
<code>-ee</code>	<code>errest.svg</code>	Output, Opt.	xvgr/xmgr file
<code>-bal</code>	<code>ballisitc.svg</code>	Output, Opt.	xvgr/xmgr file
<code>-g</code>	<code>fitlog.log</code>	Output, Opt.	Log file

Other options

<code>-h</code>	bool	no	Print help info and quit
<code>-version</code>	bool	no	Print version info and quit
<code>-nice</code>	int	0	Set the nicelevel
<code>-w</code>	bool	no	View output <code>.svg</code> , <code>.xpm</code> , <code>.eps</code> and <code>.pdb</code> files
<code>-xvgr</code>	enum	xmgrace	xvgr plot formatting: <code>xmgrace</code> , <code>xmgr</code> or <code>none</code>
<code>-time</code>	bool	yes	Expect a time in the input
<code>-b</code>	real	-1	First time to read from set
<code>-e</code>	real	-1	Last time to read from set
<code>-n</code>	int	1	Read this number of sets separated by &
<code>-d</code>	bool	no	Use the derivative
<code>-bw</code>	real	0.1	Binwidth for the distribution
<code>-errbar</code>	enum	none	Error bars for <code>-av</code> : <code>none</code> , <code>stddev</code> , <code>error</code> or <code>90</code>
<code>-integrate</code>	bool	no	Integrate data function(s) numerically using trapezium rule
<code>-aver_start</code>	real	0	Start averaging the integral from here
<code>-xydy</code>	bool	no	Interpret second data set as error in the y values for integrating
<code>-regression</code>	bool	no	Perform a linear regression analysis on the data. If <code>-xydy</code> is set a second set will be interpreted as the error bar in the Y value. Otherwise, if multiple data sets are present a multilinear regression will be performed yielding the constant A that minimize $\chi^2 = (y - A_0x_0 - A_1x_1 - \dots - A_Nx_N)^2$ where now Y is the first data set in the input file and x_i the others. Do read the information at the option <code>-time</code> .
<code>-luzar</code>	bool	no	Do a Luzar and Chandler analysis on a correlation function and related as produced by <code>g_hbond</code> . When in addition the <code>-xydy</code> flag is given the second and fourth column will be interpreted as errors in $c(t)$ and $n(t)$.
<code>-temp</code>	real	298.15	Temperature for the Luzar hydrogen bonding kinetics analysis (K)
<code>-fitstart</code>	real	1	Time (ps) from which to start fitting the correlation functions in order to obtain the forward and backward rate constants for HB breaking and formation
<code>-fitend</code>	real	60	Time (ps) where to stop fitting the correlation functions in order to obtain the forward and backward rate constants for HB breaking and formation. Only with <code>-gem</code>
<code>-smooth</code>	real	-1	If this value is ≥ 0 , the tail of the ACF will be smoothed by fitting it to an exponential function: $y = A \exp(-x/\tau)$
<code>-filter</code>	real	0	Print the high-frequency fluctuation after filtering with a cosine filter of this length
<code>-power</code>	bool	no	Fit data to: $b t^a$
<code>-subav</code>	bool	yes	Subtract the average before autocorrelating
<code>-oneacf</code>	bool	no	Calculate one ACF over all sets
<code>-acflen</code>	int	-1	Length of the ACF, default is half the number of frames

<code>-normalize</code>	bool	yes	Normalize ACF
<code>-P</code>	enum	0	Order of Legendre polynomial for ACF (0 indicates none): 0, 1, 2 or 3
<code>-fitfn</code>	enum	none	Fit function: none, exp, aexp, exp_exp, vac, exp5, exp7, exp9 or erffit
<code>-ncskip</code>	int	0	Skip this many points in the output file of correlation functions
<code>-beginfit</code>	real	0	Time where to begin the exponential fit of the correlation function
<code>-endfit</code>	real	-1	Time where to end the exponential fit of the correlation function, -1 is until the end

D.8 g_angle

`g_angle` computes the angle distribution for a number of angles or dihedrals.

With option `-ov`, you can plot the average angle of a group of angles as a function of time. With the `-all` option, the first graph is the average and the rest are the individual angles.

With the `-of` option, `g_angle` also calculates the fraction of trans dihedrals (only for dihedrals) as function of time, but this is probably only fun for a select few.

With option `-oc`, a dihedral correlation function is calculated.

It should be noted that the index file must contain atom triplets for angles or atom quadruplets for dihedrals. If this is not the case, the program will crash.

With option `-or`, a trajectory file is dumped containing cos and sin of selected dihedral angles, which subsequently can be used as input for a principal components analysis using `g_covar`.

Option `-ot` plots when transitions occur between dihedral rotamers of multiplicity 3 and `-oh` records a histogram of the times between such transitions, assuming the input trajectory frames are equally spaced in time.

Files

<code>-f</code>	traj.xtc	Input	Trajectory: xtc trr trj gro g96 pdb cpt
<code>-n</code>	angle.ndx	Input	Index file
<code>-od</code>	angdist.svg	Output	xvgr/xmgr file
<code>-ov</code>	angaver.svg	Output, Opt.	xvgr/xmgr file
<code>-of</code>	dihfrac.svg	Output, Opt.	xvgr/xmgr file
<code>-ot</code>	dihtrans.svg	Output, Opt.	xvgr/xmgr file
<code>-oh</code>	trhisto.svg	Output, Opt.	xvgr/xmgr file
<code>-oc</code>	dihcorr.svg	Output, Opt.	xvgr/xmgr file
<code>-or</code>	traj.trr	Output, Opt.	Trajectory in portable xdr format

Other options

<code>-h</code>	bool	no	Print help info and quit
<code>-version</code>	bool	no	Print version info and quit
<code>-nice</code>	int	19	Set the nicelevel
<code>-b</code>	time	0	First frame (ps) to read from trajectory
<code>-e</code>	time	0	Last frame (ps) to read from trajectory
<code>-dt</code>	time	0	Only use frame when $t \text{ MOD } dt = \text{first time (ps)}$
<code>-w</code>	bool	no	View output .svg, .xpm, .eps and .pdb files
<code>-xvg</code>	enum	xmgrace	xvg plot formatting: xmgrace, xmgr or none
<code>-type</code>	enum	angle	Type of angle to analyse: angle, dihedral, improper or ryckaert-bellemans
<code>-all</code>	bool	no	Plot all angles separately in the averages file, in the order of appearance in the index file.
<code>-binwidth</code>	real	1	binwidth (degrees) for calculating the distribution

<code>-periodic</code>	bool	yes	Print dihedral angles modulo 360 degrees
<code>-chandler</code>	bool	no	Use Chandler correlation function ($N[\text{trans}] = 1$, $N[\text{gauche}] = 0$) rather than cosine correlation function. Trans is defined as $\phi < -60$ or $\phi > 60$.
<code>-avercorr</code>	bool	no	Average the correlation functions for the individual angles/dihedrals
<code>-acflen</code>	int	-1	Length of the ACF, default is half the number of frames
<code>-normalize</code>	bool	yes	Normalize ACF
<code>-P</code>	enum	0	Order of Legendre polynomial for ACF (0 indicates none): 0, 1, 2 or 3
<code>-fitfn</code>	enum	none	Fit function: none, exp, aexp, exp_exp, vac, exp5, exp7, exp9 or erffit
<code>-ncskip</code>	int	0	Skip this many points in the output file of correlation functions
<code>-beginfit</code>	real	0	Time where to begin the exponential fit of the correlation function
<code>-endfit</code>	real	-1	Time where to end the exponential fit of the correlation function, -1 is until the end

- Counting transitions only works for dihedrals with multiplicity 3

D.9 *g_bar*

g_bar calculates free energy difference estimates through Bennett's acceptance ratio method (BAR). It also automatically adds series of individual free energies obtained with BAR into a combined free energy estimate.

Every individual BAR free energy difference relies on two simulations at different states: say state A and state B, as controlled by a parameter, λ (see the `.mdp` parameter `init_lambda`). The BAR method calculates a ratio of weighted average of the Hamiltonian difference of state B given state A and vice versa. The energy differences to the other state must be calculated explicitly during the simulation. This can be done with the `.mdp` option `foreign_lambda`.

Input option `-f` expects multiple `dhdl.xvg` files. Two types of input files are supported:

* Files with more than one y -value. The files should have columns with $dH/d\lambda$ and $\Delta\lambda$. The λ values are inferred from the legends: λ of the simulation from the legend of $dH/d\lambda$ and the foreign λ values from the legends of ΔH

* Files with only one y -value. Using the `-extp` option for these files, it is assumed that the y -value is $dH/d\lambda$ and that the Hamiltonian depends linearly on λ . The λ value of the simulation is inferred from the subtitle (if present), otherwise from a number in the subdirectory in the file name.

The λ of the simulation is parsed from `dhdl.xvg` file's legend containing the string 'dH', the foreign λ values from the legend containing the capitalized letters 'D' and 'H'. The temperature is parsed from the legend line containing 'T='.

The input option `-g` expects multiple `.edr` files. These can contain either lists of energy differences (see the `.mdp` option `separate_dhdl_file`), or a series of histograms (see the `.mdp` options `dh_hist_size` and `dh_hist_spacing`). The temperature and λ values are automatically deduced from the `ener.edr` file.

In addition to the `.mdp` option `foreign_lambda`, the energy difference can also be extrapolated from the $dH/d\lambda$ values. This is done with the `-extp` option, which assumes that the system's Hamiltonian depends linearly on λ , which is not normally the case.

The free energy estimates are determined using BAR with bisection, with the precision of the output set with `-prec`. An error estimate taking into account time correlations is made by splitting the data into blocks and determining the free energy differences over those blocks and assuming the blocks are independent. The final error estimate is determined from the average variance over 5 blocks. A range of block numbers for error estimation can be provided with the options `-nbmin` and `-nbmax`.

`g_bar` tries to aggregate samples with the same 'native' and 'foreign' λ values, but always assumes independent samples. **Note** that when aggregating energy differences/derivatives with different sampling intervals, this is almost certainly not correct. Usually subsequent energies are correlated and different time intervals mean different degrees of correlation between samples.

The results are split in two parts: the last part contains the final results in kJ/mol, together with the error estimate for each part and the total. The first part contains detailed free energy difference estimates and phase space overlap measures in units of kT (together with their computed error estimate). The printed values are:

- * lam_A: the λ values for point A.
- * lam_B: the λ values for point B.
- * DG: the free energy estimate.
- * s_A: an estimate of the relative entropy of B in A.
- * s_B: an estimate of the relative entropy of A in B.
- * stdev: an estimate expected per-sample standard deviation.

The relative entropy of both states in each other's ensemble can be interpreted as a measure of phase space overlap: the relative entropy s_A of the work samples of λ_B in the ensemble of λ_A (and vice versa for s_B), is a measure of the 'distance' between Boltzmann distributions of the two states, that goes to zero for identical distributions. See Wu & Kofke, J. Chem. Phys. 123 084109 (2005) for more information.

The estimate of the expected per-sample standard deviation, as given in Bennett's original BAR paper: Bennett, J. Comp. Phys. 22, p 245 (1976). Eq. 10 therein gives an estimate of the quality of sampling (not directly of the actual statistical error, because it assumes independent samples).

To get a visual estimate of the phase space overlap, use the `-oh` option to write series of histograms, together with the `-nbin` option.

Files

<code>-f</code>	<code>dhdl.xvg</code>	Input, Opt., <code>Multigr/xmgr</code> file
<code>-g</code>	<code>ener.edr</code>	Input, Opt., <code>File</code> energy file
<code>-o</code>	<code>bar.xvg</code>	Output, Opt. <code>xvgr/xmgr</code> file
<code>-oi</code>	<code>barint.xvg</code>	Output, Opt. <code>xvgr/xmgr</code> file
<code>-oh</code>	<code>histogram.xvg</code>	Output, Opt. <code>xvgr/xmgr</code> file

Other options

<code>-h</code>	bool	no	Print help info and quit
<code>-version</code>	bool	no	Print version info and quit
<code>-nice</code>	int	0	Set the nicelevel
<code>-w</code>	bool	no	View output <code>.xvg</code> , <code>.xpm</code> , <code>.eps</code> and <code>.pdb</code> files
<code>-xvg</code>	enum	<code>xmgrace</code>	xvg plot formatting: <code>xmgrace</code> , <code>xmgr</code> or <code>none</code>
<code>-b</code>	real	0	Begin time for BAR
<code>-e</code>	real	-1	End time for BAR
<code>-temp</code>	real	-1	Temperature (K)
<code>-prec</code>	int	2	The number of digits after the decimal point
<code>-nbmin</code>	int	5	Minimum number of blocks for error estimation
<code>-nbmax</code>	int	5	Maximum number of blocks for error estimation
<code>-nbin</code>	int	100	Number of bins for histogram output
<code>-extp</code>	bool	no	Whether to linearly extrapolate <code>dH/dl</code> values to use as energies

D.10 g_bond

`g_bond` makes a distribution of bond lengths. If all is well a Gaussian distribution should be made when using a harmonic potential. Bonds are read from a single group in the index file in order `i1-j1 i2-j2` through `in-jn`.

`-tol` gives the half-width of the distribution as a fraction of the bondlength (`-blen`). That means, for a bond of 0.2 a `tol` of 0.1 gives a distribution from 0.18 to 0.22.

Option `-d` plots all the distances as a function of time. This requires a structure file for the atom and residue names in the output. If however the option `-averdist` is given (as well or separately) the average bond length is plotted instead.

Files

<code>-f</code>	<code>traj.xtc</code>	Input	Trajectory: xtc trr trj gro g96 pdb cpt
<code>-n</code>	<code>index.ndx</code>	Input	Index file
<code>-s</code>	<code>topol.tpr</code>	Input, Opt.	Structure+mass(db): tpr tpb tpa gro g96 pdb
<code>-o</code>	<code>bonds.xvg</code>	Output	xvgr/xmgr file
<code>-l</code>	<code>bonds.log</code>	Output, Opt.	Log file
<code>-d</code>	<code>distance.xvg</code>	Output, Opt.	xvgr/xmgr file

Other options

<code>-h</code>	bool	no	Print help info and quit
<code>-version</code>	bool	no	Print version info and quit
<code>-nice</code>	int	19	Set the nicelevel
<code>-b</code>	time	0	First frame (ps) to read from trajectory
<code>-e</code>	time	0	Last frame (ps) to read from trajectory
<code>-dt</code>	time	0	Only use frame when $t \text{ MOD } dt = \text{first time (ps)}$
<code>-w</code>	bool	no	View output <code>.xvg</code> , <code>.xpm</code> , <code>.eps</code> and <code>.pdb</code> files
<code>-xvg</code>	enum	xmgrace	xvg plot formatting: xmgrace, xmgr or none
<code>-blen</code>	real	-1	Bond length. By default length of first bond
<code>-tol</code>	real	0.1	Half width of distribution as fraction of <code>-blen</code>
<code>-aver</code>	bool	yes	Average bond length distributions
<code>-averdist</code>	bool	yes	Average distances (turns on <code>-d</code>)

- It should be possible to get bond information from the topology.

D.11 *g_bundle*

`g_bundle` analyzes bundles of axes. The axes can be for instance helix axes. The program reads two index groups and divides both of them in `-na` parts. The centers of mass of these parts define the tops and bottoms of the axes. Several quantities are written to file: the axis length, the distance and the z-shift of the axis mid-points with respect to the average center of all axes, the total tilt, the radial tilt and the lateral tilt with respect to the average axis.

With options `-ok`, `-okr` and `-okl` the total, radial and lateral kinks of the axes are plotted. An extra index group of kink atoms is required, which is also divided into `-na` parts. The kink angle is defined as the angle between the kink-top and the bottom-kink vectors.

With option `-oa` the top, mid (or kink when `-ok` is set) and bottom points of each axis are written to a `.pdb` file each frame. The residue numbers correspond to the axis numbers. When viewing this file with Rasmol, use the command line option `-nmrpdb`, and type `set axis true` to display the reference axis.

Files

<code>-f</code>	<code>traj.xtc</code>	Input	Trajectory: xtc trr trj gro g96 pdb cpt
<code>-s</code>	<code>topol.tpr</code>	Input	Structure+mass(db): tpr tpb tpa gro g96 pdb
<code>-n</code>	<code>index.ndx</code>	Input, Opt.	Index file
<code>-ol</code>	<code>bun_len.xvg</code>	Output	xvgr/xmgr file

-od	bun_dist.xvg	Output	xvgr/xmgr file
-oz	bun_z.xvg	Output	xvgr/xmgr file
-ot	bun_tilt.xvg	Output	xvgr/xmgr file
-otr	bun_tiltr.xvg	Output	xvgr/xmgr file
-otl	bun_tiltl.xvg	Output	xvgr/xmgr file
-ok	bun_kink.xvg	Output, Opt.	xvgr/xmgr file
-okr	bun_kinkr.xvg	Output, Opt.	xvgr/xmgr file
-okl	bun_kinkl.xvg	Output, Opt.	xvgr/xmgr file
-oa	axes.pdb	Output, Opt.	Protein data bank file

Other options

-h	bool	no	Print help info and quit
-version	bool	no	Print version info and quit
-nice	int	19	Set the nicelevel
-b	time	0	First frame (ps) to read from trajectory
-e	time	0	Last frame (ps) to read from trajectory
-dt	time	0	Only use frame when $t \text{ MOD } dt = \text{first time (ps)}$
-tu	enum	ps	Time unit: fs, ps, ns, us, ms or s
-xvg	enum	xmgrace	xvg plot formatting: xmgrace, xmgr or none
-na	int	0	Number of axes
-z	bool	no	Use the z-axis as reference instead of the average axis

D.12 g_chi

`g_chi` computes ϕ , ψ , ω , and χ dihedrals for all your amino acid backbone and sidechains. It can compute dihedral angle as a function of time, and as histogram distributions. The distributions (`histo-(dihedral) (RESIDUE) .xvg`) are cumulative over all residues of each type.

If option `-corr` is given, the program will calculate dihedral autocorrelation functions. The function used is $C(t) = \langle \cos(\chi(\tau)) \cos(\chi(\tau + t)) \rangle$. The use of cosines rather than angles themselves, resolves the problem of periodicity. (Van der Spoel & Berendsen (1997), *Biophys. J.* 72, 2032-2041). Separate files for each dihedral of each residue (`corr(dihedral) (RESIDUE) (nresnr) .xvg`) are output, as well as a file containing the information for all residues (argument of `-corr`).

With option `-all`, the angles themselves as a function of time for each residue are printed to separate files (`(dihedral) (RESIDUE) (nresnr) .xvg`). These can be in radians or degrees.

A log file (argument `-g`) is also written. This contains

- information about the number of residues of each type.
- The NMR 3J coupling constants from the Karplus equation.
- a table for each residue of the number of transitions between rotamers per nanosecond, and the order parameter S^2 of each dihedral.
- a table for each residue of the rotamer occupancy.

All rotamers are taken as 3-fold, except for ω and χ dihedrals to planar groups (i.e. χ_2 of aromatics, Asp and Asn; χ_3 of Glu and Gln; and χ_4 of Arg), which are 2-fold. "rotamer 0" means that the dihedral was not in the core region of each rotamer. The width of the core region can be set with `-core_rotamer`

The S^2 order parameters are also output to an `.xvg` file (argument `-o`) and optionally as a `.pdb` file with the S^2 values as B-factor (argument `-p`). The total number of rotamer transitions per timestep (argument `-ot`), the number of transitions per rotamer (argument `-rt`), and the 3J couplings (argument `-jc`), can also be written to `.xvg` files. Note that the analysis of rotamer transitions assumes that the supplied trajectory frames are equally spaced in time.

If `-chi_prod` is set (and `-maxchi > 0`), cumulative rotamers, e.g. $1+9(\chi_1-1)+3(\chi_2-1)+(\chi_3-1)$ (if the residue has three 3-fold dihedrals and `-maxchi \geq 3`) are calculated. As before, if any dihedral is not in the core region, the rotamer is taken to be 0. The occupancies of these cumulative rotamers (starting with rotamer 0) are written to the file that is the argument of `-cp`, and if the `-all` flag is given, the rotamers as functions of time are written to `chiproduct (RESIDUE) (nresnr) .xvg` and their occupancies to `histo-chiproduct (RESIDUE) (nresnr) .xvg`.

The option `-r` generates a contour plot of the average ω angle as a function of the ϕ and ψ angles, that is, in a Ramachandran plot the average ω angle is plotted using color coding.

Files

<code>-s</code>	<code>conf.gro</code>	Input	Structure file: <code>gro g96 pdb tpr</code> etc.
<code>-f</code>	<code>traj.xtc</code>	Input	Trajectory: <code>xtc trr trj gro g96 pdb cpt</code>
<code>-o</code>	<code>order.xvg</code>	Output	<code>xvgr/xmgr</code> file
<code>-p</code>	<code>order.pdb</code>	Output, Opt.	Protein data bank file
<code>-ss</code>	<code>ssdump.dat</code>	Input, Opt.	Generic data file
<code>-jc</code>	<code>Jcoupling.xvg</code>	Output	<code>xvgr/xmgr</code> file
<code>-corr</code>	<code>dihcorr.xvg</code>	Output, Opt.	<code>xvgr/xmgr</code> file
<code>-g</code>	<code>chi.log</code>	Output	Log file
<code>-ot</code>	<code>dihtrans.xvg</code>	Output, Opt.	<code>xvgr/xmgr</code> file
<code>-oh</code>	<code>trhisto.xvg</code>	Output, Opt.	<code>xvgr/xmgr</code> file
<code>-rt</code>	<code>restrans.xvg</code>	Output, Opt.	<code>xvgr/xmgr</code> file
<code>-cp</code>	<code>chiprodhisto.xvg</code>	Output, Opt.	<code>xvgr/xmgr</code> file

Other options

<code>-h</code>	bool	no	Print help info and quit
<code>-version</code>	bool	no	Print version info and quit
<code>-nice</code>	int	19	Set the nicelevel
<code>-b</code>	time	0	First frame (ps) to read from trajectory
<code>-e</code>	time	0	Last frame (ps) to read from trajectory
<code>-dt</code>	time	0	Only use frame when $t \text{ MOD } dt = \text{first time (ps)}$
<code>-w</code>	bool	no	View output <code>.xvg</code> , <code>.xpm</code> , <code>.eps</code> and <code>.pdb</code> files
<code>-xvg</code>	enum	<code>xmgrace</code>	xvg plot formatting: <code>xmgrace</code> , <code>xmgr</code> or <code>none</code>
<code>-r0</code>	int	1	starting residue
<code>-phi</code>	bool	no	Output for ϕ dihedral angles
<code>-psi</code>	bool	no	Output for ψ dihedral angles
<code>-omega</code>	bool	no	Output for ω dihedrals (peptide bonds)
<code>-rama</code>	bool	no	Generate ϕ/ψ and χ_1/χ_2 Ramachandran plots
<code>-viol</code>	bool	no	Write a file that gives 0 or 1 for violated Ramachandran angles
<code>-periodic</code>	bool	yes	Print dihedral angles modulo 360 degrees
<code>-all</code>	bool	no	Output separate files for every dihedral.
<code>-rad</code>	bool	no	in angle vs time files, use radians rather than degrees.
<code>-shift</code>	bool	no	Compute chemical shifts from ϕ/ψ angles
<code>-binwidth</code>	int	1	bin width for histograms (degrees)
<code>-core_rotamer</code>	real	0.5	only the central <code>-core_rotamer*(360/multiplicity)</code> belongs to each rotamer (the rest is assigned to rotamer 0)
<code>-maxchi</code>	enum	0	calculate first <code>ndih</code> χ dihedrals: 0, 1, 2, 3, 4, 5 or 6
<code>-normhisto</code>	bool	yes	Normalize histograms
<code>-ramomega</code>	bool	no	compute average omega as a function of ϕ/ψ and plot it in an <code>.xpm</code> plot
<code>-bfact</code>	real	-1	B-factor value for <code>.pdb</code> file for atoms with no calculated dihedral order parameter
<code>-chi_prod</code>	bool	no	compute a single cumulative rotamer for each residue
<code>-HChi</code>	bool	no	Include dihedrals to sidechain hydrogens

<code>-bmax</code>	real	0	Maximum B-factor on any of the atoms that make up a dihedral, for the dihedral angle to be considered in the statistics. Applies to database work where a number of X-Ray structures is analyzed. $-bmax \leq 0$ means no limit.
<code>-acflen</code>	int	-1	Length of the ACF, default is half the number of frames
<code>-normalize</code>	bool	yes	Normalize ACF
	<code>-P</code>	enum	0 Order of Legendre polynomial for ACF (0 indicates none): 0, 1, 2 or 3
<code>-fitfn</code>	enum	none	Fit function: none, exp, aexp, exp_exp, vac, exp5, exp7, exp9 or <code>erffit</code>
<code>-ncskip</code>	int	0	Skip this many points in the output file of correlation functions
<code>-beginfit</code>	real	0	Time where to begin the exponential fit of the correlation function
<code>-endfit</code>	real	-1	Time where to end the exponential fit of the correlation function, -1 is until the end

- Produces MANY output files (up to about 4 times the number of residues in the protein, twice that if autocorrelation functions are calculated). Typically several hundred files are output.
- ϕ and ψ dihedrals are calculated in a non-standard way, using H-N-CA-C for ϕ instead of C(-)-N-CA-C, and N-CA-C-O for ψ instead of N-CA-C-N(+). This causes (usually small) discrepancies with the output of other tools like `g_rama`.
- `-r0` option does not work properly
- Rotamers with multiplicity 2 are printed in `chi.log` as if they had multiplicity 3, with the 3rd (g(+)) always having probability 0

D.13 g_cluster

`g_cluster` can cluster structures using several different methods. Distances between structures can be determined from a trajectory or read from an `.xpm` matrix file with the `-dm` option. RMS deviation after fitting or RMS deviation of atom-pair distances can be used to define the distance between structures.

single linkage: add a structure to a cluster when its distance to any element of the cluster is less than `cutoff`.

Jarvis Patrick: add a structure to a cluster when this structure and a structure in the cluster have each other as neighbors and they have a least `P` neighbors in common. The neighbors of a structure are the `M` closest structures or all structures within `cutoff`.

Monte Carlo: reorder the RMSD matrix using Monte Carlo.

diagonalization: diagonalize the RMSD matrix.

gromos: use algorithm as described in Daura *et al.* (*Angew. Chem. Int. Ed.* **1999**, 38, pp 236-240). Count number of neighbors using cut-off, take structure with largest number of neighbors with all its neighbors as cluster and eliminate it from the pool of clusters. Repeat for remaining structures in pool.

When the clustering algorithm assigns each structure to exactly one cluster (single linkage, Jarvis Patrick and gromos) and a trajectory file is supplied, the structure with the smallest average distance to the others or the average structure or all structures for each cluster will be written to a trajectory file. When writing all structures, separate numbered files are made for each cluster.

Two output files are always written:

`-o` writes the RMSD values in the upper left half of the matrix and a graphical depiction of the clusters in the lower right half. When `-minstruct = 1` the graphical depiction is black when two structures are in the same cluster. When `-minstruct > 1` different colors will be used for each cluster.

`-g` writes information on the options used and a detailed list of all clusters and their members.

Additionally, a number of optional output files can be written:

- dist writes the RMSD distribution.
- ev writes the eigenvectors of the RMSD matrix diagonalization.
- sz writes the cluster sizes.
- tr writes a matrix of the number transitions between cluster pairs.
- ntr writes the total number of transitions to or from each cluster.
- clid writes the cluster number as a function of time.
- cl writes average (with option -av) or central structure of each cluster or writes numbered files with cluster members for a selected set of clusters (with option -wcl, depends on -nst and -rmsmin). The center of a cluster is the structure with the smallest average RMSD from all other structures of the cluster.

Files

-f	traj.xtc	Input, Opt.	Trajectory: xtc trr trj gro g96 pdb cpt
-s	topol.tpr	Input, Opt.	Structure+mass(db): tpr tpb tpa gro g96 pdb
-n	index.ndx	Input, Opt.	Index file
-dm	rmsd.xpm	Input, Opt.	X PixMap compatible matrix file
-o	rmsd-clust.xpm	Output	X PixMap compatible matrix file
-g	cluster.log	Output	Log file
-dist	rmsd-dist.xvg	Output, Opt.	xvgr/xmgr file
-ev	rmsd-eig.xvg	Output, Opt.	xvgr/xmgr file
-sz	clust-size.xvg	Output, Opt.	xvgr/xmgr file
-tr	clust-trans.xpm	Output, Opt.	X PixMap compatible matrix file
-ntr	clust-trans.xvg	Output, Opt.	xvgr/xmgr file
-clid	clust-id.xvg	Output, Opt.	xvgr/xmgr file
-cl	clusters.pdb	Output, Opt.	Trajectory: xtc trr trj gro g96 pdb cpt

Other options

-h	bool	no	Print help info and quit
-version	bool	no	Print version info and quit
-nice	int	19	Set the nicelevel
-b	time	0	First frame (ps) to read from trajectory
-e	time	0	Last frame (ps) to read from trajectory
-dt	time	0	Only use frame when $t \text{ MOD } dt = \text{first time (ps)}$
-tu	enum	ps	Time unit: fs, ps, ns, us, ms or s
-w	bool	no	View output .xvg, .xpm, .eps and .pdb files
-xvg	enum	xmgrace	xvg plot formatting: xmgrace, xmgr or none
-dista	bool	no	Use RMSD of distances instead of RMS deviation
-nlevels	int	40	Discretize RMSD matrix in this number of levels
-cutoff	real	0.1	RMSD cut-off (nm) for two structures to be neighbor
-fit	bool	yes	Use least squares fitting before RMSD calculation
-max	real	-1	Maximum level in RMSD matrix
-skip	int	1	Only analyze every nr-th frame
-av	bool	no	Write average iso middle structure for each cluster
-wcl	int	0	Write the structures for this number of clusters to numbered files
-nst	int	1	Only write all structures if more than this number of structures per cluster
-rmsmin	real	0	minimum rms difference with rest of cluster for writing structures
-method	enum	linkage	Method for cluster determination: linkage, jarvis-patrick, monte-carlo, diagonalization or gromos
-minstruct	int	1	Minimum number of structures in cluster for coloring in the .xpm file
-binary	bool	no	Treat the RMSD matrix as consisting of 0 and 1, where the cut-off is given by -cutoff
-M	int	10	Number of nearest neighbors considered for Jarvis-Patrick algorithm, 0 is use cutoff

-P	int	3	Number of identical nearest neighbors required to form a cluster
-seed	int	1993	Random number seed for Monte Carlo clustering algorithm
-niter	int	10000	Number of iterations for MC
-kT	real	0.001	Boltzmann weighting factor for Monte Carlo optimization (zero turns off uphill steps)
-pbc	bool	yes	PBC check

D.14 g_clustsize

This program computes the size distributions of molecular/atomic clusters in the gas phase. The output is given in the form of an `.xpm` file. The total number of clusters is written to an `.xvg` file.

When the `-mol` option is given clusters will be made out of molecules rather than atoms, which allows clustering of large molecules. In this case an index file would still contain atom numbers or your calculation will die with a SEGV.

When velocities are present in your trajectory, the temperature of the largest cluster will be printed in a separate `.xvg` file assuming that the particles are free to move. If you are using constraints, please correct the temperature. For instance water simulated with SHAKE or SETTLE will yield a temperature that is 1.5 times too low. You can compensate for this with the `-ndf` option. Remember to take the removal of center of mass motion into account.

The `-mc` option will produce an index file containing the atom numbers of the largest cluster.

Files

-f	traj.xtc	Input	Trajectory: xtc trr trj gro g96 pdb cpt
-s	topol.tpr	Input, Opt.	Portable xdr run input file
-n	index.ndx	Input, Opt.	Index file
-o	csize.xpm	Output	X PixMap compatible matrix file
-ow	csizew.xpm	Output	X PixMap compatible matrix file
-nc	nclust.xvg	Output	xvgr/xmgr file
-mc	maxclust.xvg	Output	xvgr/xmgr file
-ac	avclust.xvg	Output	xvgr/xmgr file
-h	hdisto-clust.xvg	Output	xvgr/xmgr file
-temp	temp.xvg	Output, Opt.	xvgr/xmgr file
-mcn	maxclust.ndx	Output, Opt.	Index file

Other options

-h	bool	no	Print help info and quit
-version	bool	no	Print version info and quit
-nice	int	19	Set the nicelevel
-b	time	0	First frame (ps) to read from trajectory
-e	time	0	Last frame (ps) to read from trajectory
-dt	time	0	Only use frame when $t \text{ MOD } dt = \text{first time (ps)}$
-tu	enum	ps	Time unit: fs, ps, ns, us, ms or s
-w	bool	no	View output <code>.xvg</code> , <code>.xpm</code> , <code>.eps</code> and <code>.pdb</code> files
-xvg	enum	xmgrace	xvg plot formatting: <code>xmgrace</code> , <code>xmgr</code> or <code>none</code>
-cut	real	0.35	Largest distance (nm) to be considered in a cluster
-mol	bool	no	Cluster molecules rather than atoms (needs <code>.tpr</code> file)
-pbc	bool	yes	Use periodic boundary conditions
-nskip	int	0	Number of frames to skip between writing
-nlevels	int	20	Number of levels of grey in <code>.xpm</code> output
-ndf	int	-1	Number of degrees of freedom of the entire system for temperature calculation. If not set, the number of atoms times three is used.

```
-rgblo vector  1 1 0  RGB values for the color of the lowest occupied cluster size
-rgbhi vector  0 0 1  RGB values for the color of the highest occupied cluster size
```

D.15 *g_confrms*

g_confrms computes the root mean square deviation (RMSD) of two structures after least-squares fitting the second structure on the first one. The two structures do NOT need to have the same number of atoms, only the two index groups used for the fit need to be identical. With *-name* only matching atom names from the selected groups will be used for the fit and RMSD calculation. This can be useful when comparing mutants of a protein.

The superimposed structures are written to file. In a *.pdb* file the two structures will be written as separate models (use *rasmol -nmrpdb*). Also in a *.pdb* file, B-factors calculated from the atomic MSD values can be written with *-bfac*.

Files

```
-f1      conf1.gro  Input      Structure+mass(db): tpr tpb tpa gro g96 pdb
-f2      conf2.gro  Input      Structure file: gro g96 pdb tpr etc.
-o       fit.pdb   Output     Structure file: gro g96 pdb etc.
-n1      fit1.ndx  Input, Opt. Index file
-n2      fit2.ndx  Input, Opt. Index file
-no      match.ndx Output, Opt. Index file
```

Other options

```
-h      bool      no  Print help info and quit
-version bool      no  Print version info and quit
-nice   int       19  Set the nicelevel
-w      bool      no  View output .xvg, .xpm, .eps and .pdb files
-one    bool      no  Only write the fitted structure to file
-mw     bool      yes  Mass-weighted fitting and RMSD
-pbc    bool      no  Try to make molecules whole again
-fit    bool      yes  Do least squares superposition of the target structure to the reference
-name   bool      no  Only compare matching atom names
-label  bool      no  Added chain labels A for first and B for second structure
-bfac   bool      no  Output B-factors from atomic MSD values
```

D.16 *g_covar*

g_covar calculates and diagonalizes the (mass-weighted) covariance matrix. All structures are fitted to the structure in the structure file. When this is not a run input file periodicity will not be taken into account. When the fit and analysis groups are identical and the analysis is non mass-weighted, the fit will also be non mass-weighted.

The eigenvectors are written to a trajectory file (*-v*). When the same atoms are used for the fit and the covariance analysis, the reference structure for the fit is written first with *t=-1*. The average (or reference when *-ref* is used) structure is written with *t=0*, the eigenvectors are written as frames with the eigenvector number as timestamp.

The eigenvectors can be analyzed with *g_anaeig*.

Option *-ascii* writes the whole covariance matrix to an ASCII file. The order of the elements is: *x1x1, x1y1, x1z1, x1x2, ...*

Option `-xpm` writes the whole covariance matrix to an `.xpm` file.

Option `-xpma` writes the atomic covariance matrix to an `.xpm` file, i.e. for each atom pair the sum of the `xx`, `yy` and `zz` covariances is written.

Note that the diagonalization of a matrix requires memory and time that will increase at least as fast as than the square of the number of atoms involved. It is easy to run out of memory, in which case this tool will probably exit with a 'Segmentation fault'. You should consider carefully whether a reduced set of atoms will meet your needs for lower costs.

Files

<code>-f</code>	<code>traj.xtc</code>	Input	Trajectory: <code>xtc trr trj gro g96 pdb cpt</code>
<code>-s</code>	<code>topol.tpr</code>	Input	Structure+mass(db): <code>tpr tpb tpa gro g96 pdb</code>
<code>-n</code>	<code>index.ndx</code>	Input, Opt.	Index file
<code>-o</code>	<code>eigenval.xvg</code>	Output	<code>xvgr/xmgr</code> file
<code>-v</code>	<code>eigenvec.trr</code>	Output	Full precision trajectory: <code>trr trj cpt</code>
<code>-av</code>	<code>average.pdb</code>	Output	Structure file: <code>gro g96 pdb</code> etc.
<code>-l</code>	<code>covar.log</code>	Output	Log file
<code>-ascii</code>	<code>covar.dat</code>	Output, Opt.	Generic data file
<code>-xpm</code>	<code>covar.xpm</code>	Output, Opt.	X PixMap compatible matrix file
<code>-xpma</code>	<code>covara.xpm</code>	Output, Opt.	X PixMap compatible matrix file

Other options

<code>-h</code>	bool	no	Print help info and quit
<code>-version</code>	bool	no	Print version info and quit
<code>-nice</code>	int	19	Set the nicelevel
<code>-b</code>	time	0	First frame (ps) to read from trajectory
<code>-e</code>	time	0	Last frame (ps) to read from trajectory
<code>-dt</code>	time	0	Only use frame when <code>t MOD dt = first time (ps)</code>
<code>-tu</code>	enum	ps	Time unit: <code>fs, ps, ns, us, ms</code> or <code>s</code>
<code>-xvg</code>	enum	<code>xmgrace</code>	<code>xvg</code> plot formatting: <code>xmgrace, xmgr</code> or <code>none</code>
<code>-fit</code>	bool	yes	Fit to a reference structure
<code>-ref</code>	bool	no	Use the deviation from the conformation in the structure file instead of from the average
<code>-mwa</code>	bool	no	Mass-weighted covariance analysis
<code>-last</code>	int	-1	Last eigenvector to write away (-1 is till the last)
<code>-pbc</code>	bool	yes	Apply corrections for periodic boundary conditions

D.17 g_current

`g_current` is a tool for calculating the current autocorrelation function, the correlation of the rotational and translational dipole moment of the system, and the resulting static dielectric constant. To obtain a reasonable result, the index group has to be neutral. Furthermore, the routine is capable of extracting the static conductivity from the current autocorrelation function, if velocities are given. Additionally, an Einstein-Helfand fit can be used to obtain the static conductivity.

The flag `-caf` is for the output of the current autocorrelation function and `-mc` writes the correlation of the rotational and translational part of the dipole moment in the corresponding file. However, this option is only available for trajectories containing velocities. Options `-sh` and `-tr` are responsible for the averaging and integration of the autocorrelation functions. Since averaging proceeds by shifting the starting point through the trajectory, the shift can be modified with `-sh` to enable the choice of uncorrelated starting points. Towards the end, statistical inaccuracy grows and integrating the correlation function only yields reliable values until a certain point, depending on the number of frames. The option `-tr` controls the region of the integral taken into account for calculating the static dielectric constant.

Option `-temp` sets the temperature required for the computation of the static dielectric constant.

Option `-eps` controls the dielectric constant of the surrounding medium for simulations using a Reaction Field or dipole corrections of the Ewald summation (`-eps=0` corresponds to tin-foil boundary conditions).

`-[no]nojump` unfolds the coordinates to allow free diffusion. This is required to get a continuous translational dipole moment, required for the Einstein-Helfand fit. The results from the fit allow the determination of the dielectric constant for system of charged molecules. However, it is also possible to extract the dielectric constant from the fluctuations of the total dipole moment in folded coordinates. But this option has to be used with care, since only very short time spans fulfill the approximation that the density of the molecules is approximately constant and the averages are already converged. To be on the safe side, the dielectric constant should be calculated with the help of the Einstein-Helfand method for the translational part of the dielectric constant.

Files

<code>-s</code>	<code>topol.tpr</code>	Input	Structure+mass(db): tpr tpb tpa gro g96 pdb
<code>-n</code>	<code>index.ndx</code>	Input, Opt.	Index file
<code>-f</code>	<code>traj.xtc</code>	Input	Trajectory: xtc trr trj gro g96 pdb cpt
<code>-o</code>	<code>current.xvg</code>	Output	xvgr/xmgr file
<code>-caf</code>	<code>caf.xvg</code>	Output, Opt.	xvgr/xmgr file
<code>-dsp</code>	<code>dsp.xvg</code>	Output	xvgr/xmgr file
<code>-md</code>	<code>md.xvg</code>	Output	xvgr/xmgr file
<code>-mj</code>	<code>mj.xvg</code>	Output	xvgr/xmgr file
<code>-mc</code>	<code>mc.xvg</code>	Output, Opt.	xvgr/xmgr file

Other options

<code>-h</code>	bool	no	Print help info and quit
<code>-version</code>	bool	no	Print version info and quit
<code>-nice</code>	int	0	Set the nicelevel
<code>-b</code>	time	0	First frame (ps) to read from trajectory
<code>-e</code>	time	0	Last frame (ps) to read from trajectory
<code>-dt</code>	time	0	Only use frame when $t \text{ MOD } dt = \text{first time (ps)}$
<code>-w</code>	bool	no	View output <code>.xvg</code> , <code>.xpm</code> , <code>.eps</code> and <code>.pdb</code> files
<code>-xvg</code>	enum	xmgrace	xvg plot formatting: <code>xmgrace</code> , <code>xmgr</code> or <code>none</code>
<code>-sh</code>	int	1000	Shift of the frames for averaging the correlation functions and the mean-square displacement.
<code>-nojump</code>	bool	yes	Removes jumps of atoms across the box.
<code>-eps</code>	real	0	Dielectric constant of the surrounding medium. The value zero corresponds to infinity (tin-foil boundary conditions).
<code>-bfit</code>	real	100	Begin of the fit of the straight line to the MSD of the translational fraction of the dipole moment.
<code>-efit</code>	real	400	End of the fit of the straight line to the MSD of the translational fraction of the dipole moment.
<code>-bvit</code>	real	0.5	Begin of the fit of the current autocorrelation function to $a*t^b$.
<code>-evit</code>	real	5	End of the fit of the current autocorrelation function to $a*t^b$.
<code>-tr</code>	real	0.25	Fraction of the trajectory taken into account for the integral.
<code>-temp</code>	real	300	Temperature for calculating epsilon.

D.18 *g_density*

Compute partial densities across the box, using an index file.

For the total density of NPT simulations, use `g_energy` instead.

Densities are in kg/m^3 , and number densities or electron densities can also be calculated. For electron densities, a file describing the number of electrons for each type of atom should be provided using `-ei`. It should look like:

```
2
atomname = nrelectrons
atomname = nrelectrons
```

The first line contains the number of lines to read from the file. There should be one line for each unique atom name in your system. The number of electrons for each atom is modified by its atomic partial charge.

Files

<code>-f</code>	<code>traj.xtc</code>	Input	Trajectory: xtc trr trj gro g96 pdb cpt
<code>-n</code>	<code>index.ndx</code>	Input, Opt.	Index file
<code>-s</code>	<code>topol.tpr</code>	Input	Run input file: tpr tpb tpa
<code>-ei</code>	<code>electrons.dat</code>	Input, Opt.	Generic data file
<code>-o</code>	<code>density.xvg</code>	Output	xvgr/xmgr file

Other options

<code>-h</code>	bool	no	Print help info and quit
<code>-version</code>	bool	no	Print version info and quit
<code>-nice</code>	int	19	Set the nicelevel
<code>-b</code>	time	0	First frame (ps) to read from trajectory
<code>-e</code>	time	0	Last frame (ps) to read from trajectory
<code>-dt</code>	time	0	Only use frame when $t \text{ MOD } dt = \text{first time (ps)}$
<code>-w</code>	bool	no	View output <code>.xvg</code> , <code>.xpm</code> , <code>.eps</code> and <code>.pdb</code> files
<code>-xvg</code>	enum	xmgrace	xvg plot formatting: <code>xmgrace</code> , <code>xmgr</code> or <code>none</code>
<code>-d</code>	string	Z	Take the normal on the membrane in direction X, Y or Z.
<code>-sl</code>	int	50	Divide the box in this number of slices.
<code>-dens</code>	enum	mass	Density: <code>mass</code> , <code>number</code> , <code>charge</code> or <code>electron</code>
<code>-ng</code>	int	1	Number of groups of which to compute densities.
<code>-symm</code>	bool	no	Symmetrize the density along the axis, with respect to the center. Useful for bilayers.
<code>-center</code>	bool	no	Shift the center of mass along the axis to zero. This means if your axis is Z and your box is <code>bX</code> , <code>bY</code> , <code>bZ</code> , the center of mass will be at <code>bX/2</code> , <code>bY/2</code> , 0.

- When calculating electron densities, atomnames are used instead of types. This is bad.

D.19 g_densmap

`g_densmap` computes 2D number-density maps. It can make planar and axial-radial density maps. The output `.xpm` file can be visualized with for instance `xv` and can be converted to postscript with `xpm2ps`. Optionally, output can be in text form to a `.dat` file with `-od`, instead of the usual `.xpm` file with `-o`.

The default analysis is a 2-D number-density map for a selected group of atoms in the `x-y` plane. The averaging direction can be changed with the option `-aver`. When `-xmin` and/or `-xmax` are set only atoms that are within the limit(s) in the averaging direction are taken into account. The grid spacing is set with the option `-bin`. When `-n1` or `-n2` is non-zero, the grid size is set by this option. Box size fluctuations are properly taken into account.

When options `-amax` and `-rmax` are set, an axial-radial number-density map is made. Three groups should be supplied, the centers of mass of the first two groups define the axis, the third defines the analysis group. The axial direction goes from `-amax` to `+amax`, where the center is defined as the midpoint between

the centers of mass and the positive direction goes from the first to the second center of mass. The radial direction goes from 0 to *rmax* or from *-rmax* to *+rmax* when the *-mirror* option has been set.

The normalization of the output is set with the *-unit* option. The default produces a true number density. Unit *nm-2* leaves out the normalization for the averaging or the angular direction. Option *count* produces the count for each grid cell. When you do not want the scale in the output to go from zero to the maximum density, you can set the maximum with the option *-dmax*.

Files

<i>-f</i>	<i>traj.xtc</i>	Input	Trajectory: <i>xtc trr trj gro g96 pdb cpt</i>
<i>-s</i>	<i>topol.tpr</i>	Input, Opt.	Structure+mass(db): <i>tpr tpb tpa gro g96 pdb</i>
<i>-n</i>	<i>index.ndx</i>	Input, Opt.	Index file
<i>-od</i>	<i>densmap.dat</i>	Output, Opt.	Generic data file
<i>-o</i>	<i>densmap.xpm</i>	Output	X PixMap compatible matrix file

Other options

<i>-h</i>	bool	no	Print help info and quit
<i>-version</i>	bool	no	Print version info and quit
<i>-nice</i>	int	19	Set the nicelevel
<i>-b</i>	time	0	First frame (ps) to read from trajectory
<i>-e</i>	time	0	Last frame (ps) to read from trajectory
<i>-dt</i>	time	0	Only use frame when <i>t MOD dt = first time (ps)</i>
<i>-w</i>	bool	no	View output <i>.xvg, .xpm, .eps</i> and <i>.pdb</i> files
<i>-bin</i>	real	0.02	Grid size (nm)
<i>-aver</i>	enum	<i>z</i>	The direction to average over: <i>z, y</i> or <i>x</i>
<i>-xmin</i>	real	<i>-1</i>	Minimum coordinate for averaging
<i>-xmax</i>	real	<i>-1</i>	Maximum coordinate for averaging
<i>-n1</i>	int	0	Number of grid cells in the first direction
<i>-n2</i>	int	0	Number of grid cells in the second direction
<i>-amax</i>	real	0	Maximum axial distance from the center
<i>-rmax</i>	real	0	Maximum radial distance
<i>-mirror</i>	bool	no	Add the mirror image below the axial axis
<i>-sums</i>	bool	no	Print density sums (1D map) to stdout
<i>-unit</i>	enum	<i>nm-3</i>	Unit for the output: <i>nm-3, nm-2</i> or <i>count</i>
<i>-dmin</i>	real	0	Minimum density in output
<i>-dmax</i>	real	0	Maximum density in output (0 means calculate it)

D.20 *g_densorder*

A small program to reduce a two-phase density distribution along an axis, computed over a MD trajectory to 2D surfaces fluctuating in time, by a fit to a functional profile for interfacial densities A time-averaged spatial representation of the interfaces can be output with the option *-tavg*

Files

<i>-s</i>	<i>topol.tpr</i>	Input	Run input file: <i>tpr tpb tpa</i>
<i>-f</i>	<i>traj.xtc</i>	Input	Trajectory: <i>xtc trr trj gro g96 pdb cpt</i>
<i>-n</i>	<i>index.ndx</i>	Input	Index file
<i>-o</i>	<i>Density4D.dat</i>	Output, Opt.	Generic data file
<i>-or</i>	<i>hello.out</i>	Output, Opt., Multi	Generic output file
<i>-og</i>	<i>interface.xpm</i>	Output, Opt., Multi	PixMap compatible matrix file
<i>-Spect</i>	<i>intfspect.out</i>	Output, Opt., Multi	Generic output file

Other options

-h	bool	no	Print help info and quit
-version	bool	no	Print version info and quit
-nice	int	0	Set the nicelevel
-b	time	0	First frame (ps) to read from trajectory
-e	time	0	Last frame (ps) to read from trajectory
-dt	time	0	Only use frame when t MOD dt = first time (ps)
-w	bool	no	View output .xvg, .xpm, .eps and .pdb files
-1d	bool	no	Pseudo-1d interface geometry
-bw	real	0.2	Binwidth of density distribution tangential to interface
-bwn	real	0.05	Binwidth of density distribution normal to interface
-order	int	0	Order of Gaussian filter, order 0 equates to NO filtering
-axis	string	Z	Axis Direction - X, Y or Z
-method	enum	bisect	Interface location method: bisect or functional
-d1	real	0	Bulk density phase 1 (at small z)
-d2	real	1000	Bulk density phase 2 (at large z)
-tblock	int	100	Number of frames in one time-block average
-nlevel	int	100	Number of Height levels in 2D - XPixMaps

D.21 g_dielectric

`g_dielectric` calculates frequency dependent dielectric constants from the autocorrelation function of the total dipole moment in your simulation. This ACF can be generated by `g_dipoles`. The functional forms of the available functions are:

One parameter: $y = \exp(-a_1x)$,

Two parameters: $y = a_2 \exp(-a_1x)$,

Three parameters: $y = a_2 \exp(-a_1x) + (1 - a_2) \exp(-a_3x)$.

Start values for the fit procedure can be given on the command line. It is also possible to fix parameters at their start value, use `-fix` with the number of the parameter you want to fix.

Three output files are generated, the first contains the ACF, an exponential fit to it with 1, 2 or 3 parameters, and the numerical derivative of the combination data/fit. The second file contains the real and imaginary parts of the frequency-dependent dielectric constant, the last gives a plot known as the Cole-Cole plot, in which the imaginary component is plotted as a function of the real component. For a pure exponential relaxation (Debye relaxation) the latter plot should be one half of a circle.

Files

-f	dipcorr.xvg	Input	xvgr/xmgr file
-d	deriv.xvg	Output	xvgr/xmgr file
-o	epsw.xvg	Output	xvgr/xmgr file
-c	cole.xvg	Output	xvgr/xmgr file

Other options

-h	bool	no	Print help info and quit
-version	bool	no	Print version info and quit
-nice	int	19	Set the nicelevel
-b	time	0	First frame (ps) to read from trajectory
-e	time	0	Last frame (ps) to read from trajectory
-dt	time	0	Only use frame when t MOD dt = first time (ps)
-w	bool	no	View output .xvg, .xpm, .eps and .pdb files
-xvg	enum	xmgrace	xvg plot formatting: xmgrace, xmgr or none

-fft	bool	no	use fast fourier transform for correlation function
-x1	bool	yes	use first column as <i>x</i> -axis rather than first data set
-eint	real	5	Time to end the integration of the data and start to use the fit
-bfit	real	5	Begin time of fit
-efit	real	500	End time of fit
-tail	real	500	Length of function including data and tail from fit
-A	real	0.5	Start value for fit parameter A
-tau1	real	10	Start value for fit parameter τ_1
-tau2	real	1	Start value for fit parameter τ_2
-eps0	real	80	ϵ_0 of your liquid
-epsRF	real	78.5	ϵ of the reaction field used in your simulation. A value of 0 means infinity.
-fix	int	0	Fix parameters at their start values, A (2), tau1 (1), or tau2 (4)
-ffn	enum	none	Fit function: none, exp, aexp, exp_exp, vac, exp5, exp7, exp9 or erffit
-nsmooth	int	3	Number of points for smoothing

D.22 *g_dipoles*

g_dipoles computes the total dipole plus fluctuations of a simulation system. From this you can compute e.g. the dielectric constant for low-dielectric media. For molecules with a net charge, the net charge is subtracted at center of mass of the molecule.

The file *Mtot.xvg* contains the total dipole moment of a frame, the components as well as the norm of the vector. The file *aver.xvg* contains $\langle |\mu|^2 \rangle$ and $|\langle \mu \rangle|^2$ during the simulation. The file *dipdist.xvg* contains the distribution of dipole moments during the simulation. The value of *-mumax* is used as the highest value in the distribution graph.

Furthermore, the dipole autocorrelation function will be computed when option *-corr* is used. The output file name is given with the *-c* option. The correlation functions can be averaged over all molecules (*mol*), plotted per molecule separately (*molsep*) or it can be computed over the total dipole moment of the simulation box (*total*).

Option *-g* produces a plot of the distance dependent Kirkwood G-factor, as well as the average cosine of the angle between the dipoles as a function of the distance. The plot also includes *gOO* and *hOO* according to Nyman & Linse, J. Chem. Phys. 112 (2000) pp 6386-6395. In the same plot, we also include the energy per scale computed by taking the inner product of the dipoles divided by the distance to the third power.

EXAMPLES

```
g_dipoles -corr mol -P 1 -o dip_sqr -mu 2.273 -mumax 5.0
```

This will calculate the autocorrelation function of the molecular dipoles using a first order Legendre polynomial of the angle of the dipole vector and itself a time *t* later. For this calculation 1001 frames will be used. Further, the dielectric constant will be calculated using an *-epsilonRF* of infinity (default), temperature of 300 K (default) and an average dipole moment of the molecule of 2.273 (SPC). For the distribution function a maximum of 5.0 will be used.

Files

-en	<i>ener.edr</i>	Input, Opt.	Energy file
-f	<i>traj.xtc</i>	Input	Trajectory: <i>xtc trr trj gro g96 pdb cpt</i>
-s	<i>topol.tpr</i>	Input	Run input file: <i>tpr tpb tpa</i>
-n	<i>index.ndx</i>	Input, Opt.	Index file
-o	<i>Mtot.xvg</i>	Output	<i>xvgr/xmgr</i> file
-eps	<i>epsilon.xvg</i>	Output	<i>xvgr/xmgr</i> file
-a	<i>aver.xvg</i>	Output	<i>xvgr/xmgr</i> file

-d	dipdist.xvg	Output	xvgr/xmgr file
-c	dipcorr.xvg	Output, Opt.	xvgr/xmgr file
-g	gkr.xvg	Output, Opt.	xvgr/xmgr file
-adip	adip.xvg	Output, Opt.	xvgr/xmgr file
-dip3d	dip3d.xvg	Output, Opt.	xvgr/xmgr file
-cos	cosaver.xvg	Output, Opt.	xvgr/xmgr file
-cmap	cmap.xpm	Output, Opt.	X PixMap compatible matrix file
-q	quadrupole.xvg	Output, Opt.	xvgr/xmgr file
-slab	slab.xvg	Output, Opt.	xvgr/xmgr file

Other options

-h	bool	no	Print help info and quit
-version	bool	no	Print version info and quit
-nice	int	19	Set the nicelevel
-b	time	0	First frame (ps) to read from trajectory
-e	time	0	Last frame (ps) to read from trajectory
-dt	time	0	Only use frame when $t \text{ MOD } dt = \text{first time (ps)}$
-w	bool	no	View output .xvg, .xpm, .eps and .pdb files
-xvg	enum	xmgrace	xvg plot formatting: xmgrace, xmgr or none
-mu	real	-1	dipole of a single molecule (in Debye)
-mumax	real	5	max dipole in Debye (for histogram)
-epsilonRF	real	0	ϵ of the reaction field used during the simulation, needed for dielectric constant calculation. WARNING: 0.0 means infinity (default)
-skip	int	0	Skip steps in the output (but not in the computations)
-temp	real	300	Average temperature of the simulation (needed for dielectric constant calculation)
-corr	enum	none	Correlation function to calculate: none, mol, molsep or total
-pairs	bool	yes	Calculate $ \cos(\theta) $ between all pairs of molecules. May be slow
-ncos	int	1	Must be 1 or 2. Determines whether the $\langle \cos(\theta) \rangle$ is computed between all molecules in one group, or between molecules in two different groups. This turns on the -g flag.
-axis	string	Z	Take the normal on the computational box in direction X, Y or Z.
-sl	int	10	Divide the box into this number of slices.
-gkratom	int	0	Use the n-th atom of a molecule (starting from 1) to calculate the distance between molecules rather than the center of charge (when 0) in the calculation of distance dependent Kirkwood factors
-gkratom2	int	0	Same as previous option in case ncos = 2, i.e. dipole interaction between two groups of molecules
-rcmax	real	0	Maximum distance to use in the dipole orientation distribution (with ncos == 2). If zero, a criterion based on the box length will be used.
-phi	bool	no	Plot the 'torsion angle' defined as the rotation of the two dipole vectors around the distance vector between the two molecules in the .xpm file from the -cmap option. By default the cosine of the angle between the dipoles is plotted.
-nlevels	int	20	Number of colors in the cmap output
-ndegrees	int	90	Number of divisions on the y-axis in the cmap output (for 180 degrees)
-acflen	int	-1	Length of the ACF, default is half the number of frames
-normalize	bool	yes	Normalize ACF
-P	enum	0	Order of Legendre polynomial for ACF (0 indicates none): 0, 1, 2 or 3
-fitfn	enum	none	Fit function: none, exp, aexp, exp_exp, vac, exp5, exp7, exp9 or erffit
-ncskip	int	0	Skip this many points in the output file of correlation functions
-beginfit	real	0	Time where to begin the exponential fit of the correlation function

`-endfit` real -1 Time where to end the exponential fit of the correlation function, -1 is until the end

D.23 *g_disre*

g_disre computes violations of distance restraints. If necessary, all protons can be added to a protein molecule using the *g_protonate* program.

The program always computes the instantaneous violations rather than time-averaged, because this analysis is done from a trajectory file afterwards it does not make sense to use time averaging. However, the time averaged values per restraint are given in the log file.

An index file may be used to select specific restraints for printing.

When the optional `-q` flag is given a `.pdb` file coloured by the amount of average violations.

When the `-c` option is given, an index file will be read containing the frames in your trajectory corresponding to the clusters (defined in another manner) that you want to analyze. For these clusters the program will compute average violations using the third power averaging algorithm and print them in the log file.

Files

<code>-s</code>	<code>topol.tpr</code>	Input	Run input file: tpr tpb tpa
<code>-f</code>	<code>traj.xtc</code>	Input	Trajectory: xtc trr trj gro g96 pdb cpt
<code>-ds</code>	<code>drsum.xvg</code>	Output	xvgr/xmgr file
<code>-da</code>	<code>draver.xvg</code>	Output	xvgr/xmgr file
<code>-dn</code>	<code>drnum.xvg</code>	Output	xvgr/xmgr file
<code>-dm</code>	<code>drmax.xvg</code>	Output	xvgr/xmgr file
<code>-dr</code>	<code>restr.xvg</code>	Output	xvgr/xmgr file
<code>-l</code>	<code>disres.log</code>	Output	Log file
<code>-n</code>	<code>viol.ndx</code>	Input, Opt.	Index file
<code>-q</code>	<code>viol.pdb</code>	Output, Opt.	Protein data bank file
<code>-c</code>	<code>clust.ndx</code>	Input, Opt.	Index file
<code>-x</code>	<code>matrix.xpm</code>	Output, Opt.	X PixMap compatible matrix file

Other options

<code>-h</code>	bool	no	Print help info and quit
<code>-version</code>	bool	no	Print version info and quit
<code>-nice</code>	int	19	Set the nicelevel
<code>-b</code>	time	0	First frame (ps) to read from trajectory
<code>-e</code>	time	0	Last frame (ps) to read from trajectory
<code>-dt</code>	time	0	Only use frame when $t \text{ MOD } dt = \text{first time (ps)}$
<code>-w</code>	bool	no	View output <code>.xvg</code> , <code>.xpm</code> , <code>.eps</code> and <code>.pdb</code> files
<code>-xvg</code>	enum	<code>xmgrace</code>	xvg plot formatting: <code>xmgrace</code> , <code>xmgr</code> or <code>none</code>
<code>-ntop</code>	int	0	Number of large violations that are stored in the log file every step
<code>-maxdr</code>	real	0	Maximum distance violation in matrix output. If less than or equal to 0 the maximum will be determined by the data.
<code>-nlevels</code>	int	20	Number of levels in the matrix output
<code>-third</code>	bool	yes	Use inverse third power averaging or linear for matrix output

D.24 *g_dist*

g_dist can calculate the distance between the centers of mass of two groups of atoms as a function of time. The total distance and its *x*-, *y*-, and *z*-components are plotted.

Or when `-dist` is set, print all the atoms in group 2 that are closer than a certain distance to the center of mass of group 1.

With options `-lt` and `-dist` the number of contacts of all atoms in group 2 that are closer than a certain distance to the center of mass of group 1 are plotted as a function of the time that the contact was continuously present. The `-intra` switch enables calculations of intramolecular distances avoiding distance calculation to its periodic images. For a proper function, the molecule in the input trajectory should be whole (e.g. by preprocessing with `trjconv -pbc`) or a matching topology should be provided. The `-intra` switch will only give meaningful results for intramolecular and not intermolecular distances.

Other programs that calculate distances are `g_mindist` and `g_bond`.

Files

<code>-f</code>	<code>traj.xtc</code>	Input	Trajectory: xtc trr trj gro g96 pdb cpt
<code>-s</code>	<code>topol.tpr</code>	Input	Run input file: tpr tpb tpa
<code>-n</code>	<code>index.ndx</code>	Input, Opt.	Index file
<code>-o</code>	<code>dist.xvg</code>	Output, Opt.	xvgr/xmgr file
<code>-lt</code>	<code>lifetime.xvg</code>	Output, Opt.	xvgr/xmgr file

Other options

<code>-h</code>	bool	no	Print help info and quit
<code>-version</code>	bool	no	Print version info and quit
<code>-nice</code>	int	19	Set the nicelevel
<code>-b</code>	time	0	First frame (ps) to read from trajectory
<code>-e</code>	time	0	Last frame (ps) to read from trajectory
<code>-dt</code>	time	0	Only use frame when $t \text{ MOD } dt = \text{first time (ps)}$
<code>-xvg</code>	enum	xmgrace	xvg plot formatting: <code>xmgrace</code> , <code>xmgr</code> or <code>none</code>
<code>-intra</code>	bool	no	Calculate distances without considering periodic boundaries, e.g. intramolecular.
<code>-dist</code>	real	0	Print all atoms in group 2 closer than <code>dist</code> to the center of mass of group 1

D.25 g_dos

`g_dos` computes the Density of States from a simulations. In order for this to be meaningful the velocities must be saved in the trajectory with sufficiently high frequency such as to cover all vibrations. For flexible systems that would be around a few fs between saving. Properties based on the DoS are printed on the standard output.

Files

<code>-f</code>	<code>traj.trr</code>	Input	Full precision trajectory: trr trj cpt
<code>-s</code>	<code>topol.tpr</code>	Input	Run input file: tpr tpb tpa
<code>-n</code>	<code>index.ndx</code>	Input, Opt.	Index file
<code>-vacf</code>	<code>vacf.xvg</code>	Output	xvgr/xmgr file
<code>-mvacf</code>	<code>mvacf.xvg</code>	Output	xvgr/xmgr file
<code>-dos</code>	<code>dos.xvg</code>	Output	xvgr/xmgr file
<code>-g</code>	<code>dos.log</code>	Output	Log file

Other options

<code>-h</code>	bool	no	Print help info and quit
<code>-version</code>	bool	no	Print version info and quit
<code>-nice</code>	int	19	Set the nicelevel
<code>-b</code>	time	0	First frame (ps) to read from trajectory
<code>-e</code>	time	0	Last frame (ps) to read from trajectory

-dt	time	0	Only use frame when $t \text{ MOD } dt = \text{first time (ps)}$
-w	bool	no	View output <code>.xvg</code> , <code>.xpm</code> , <code>.eps</code> and <code>.pdb</code> files
-xvg	enum	xmgrace	xvg plot formatting: <code>xmgrace</code> , <code>xmgr</code> or <code>none</code>
-v	bool	yes	Be loud and noisy.
-recip	bool	no	Use cm^{-1} on X-axis instead of $1/\text{ps}$ for DoS plots.
-abs	bool	no	Use the absolute value of the Fourier transform of the VACF as the Density of States. Default is to use the real component only
-normdos	bool	no	Normalize the DoS such that it adds up to $3N$. This is a hack that should not be necessary.
-T	real	298.15	Temperature in the simulation
-acflen	int	-1	Length of the ACF, default is half the number of frames
-normalize	bool	yes	Normalize ACF
-P	enum	0	Order of Legendre polynomial for ACF (0 indicates none): 0, 1, 2 or 3
-fitfn	enum	none	Fit function: <code>none</code> , <code>exp</code> , <code>aexp</code> , <code>exp_exp</code> , <code>vac</code> , <code>exp5</code> , <code>exp7</code> , <code>exp9</code> or <code>erffit</code>
-ncskip	int	0	Skip this many points in the output file of correlation functions
-beginfit	real	0	Time where to begin the exponential fit of the correlation function
-endfit	real	-1	Time where to end the exponential fit of the correlation function, -1 is until the end

- This program needs a lot of memory: total usage equals the number of atoms times 3 times number of frames times 4 (or 8 when run in double precision).

D.26 *g_dyecoupl*

This tool extracts dye dynamics from trajectory files. Currently, R and κ^2 between dyes is extracted for (F)RET simulations with assumed dipolar coupling as in the Foerster equation. It further allows the calculation of $R(t)$ and $\kappa^2(t)$, R and κ^2 histograms and averages, as well as the instantaneous FRET efficiency $E(t)$ for a specified Foerster radius R_0 (switch `-R0`). The input dyes have to be whole (see `res` and `mol pbc` options in `trjconv`). The dye transition dipole moment has to be defined by at least a single atom pair, however multiple atom pairs can be provided in the index file. The distance R is calculated on the basis of the COMs of the given atom pairs. The `-pbcdist` option calculates distances to the nearest periodic image instead to the distance in the box. This works however only, for periodic boundaries in all 3 dimensions. The `-norm` option (area-) normalizes the histograms.

Files

-f	traj.xtc	Input	Trajectory: <code>xtc</code> <code>trr</code> <code>trj</code> <code>gro</code> <code>g96</code> <code>pdb</code> <code>cpt</code>
-n	index.ndx	Input	Index file
-ot	rkappa.xvg	Output, Opt.	<code>xvgr/xmgr</code> file
-oe	insteff.xvg	Output, Opt.	<code>xvgr/xmgr</code> file
-o	rkappa.dat	Output, Opt.	Generic data file
-rhist	rhist.xvg	Output, Opt.	<code>xvgr/xmgr</code> file
-khist	khist.xvg	Output, Opt.	<code>xvgr/xmgr</code> file

Other options

-h	bool	no	Print help info and quit
-version	bool	no	Print version info and quit
-nice	int	19	Set the nicelevel
-b	time	0	First frame (ps) to read from trajectory
-e	time	0	Last frame (ps) to read from trajectory
-tu	enum	ps	Time unit: <code>fs</code> , <code>ps</code> , <code>ns</code> , <code>us</code> , <code>ms</code> or <code>s</code>
-w	bool	no	View output <code>.xvg</code> , <code>.xpm</code> , <code>.eps</code> and <code>.pdb</code> files

```

    -xvgr enum xmgrace  xvg plot formatting: xmgrace, xmgr or none
  -pbcdist bool      no   Distance R based on PBC
    -norm  bool      no   Normalize histograms
    -bins  int       50   # of histogram bins
    -R0    real      -1   Foerster radius including  $\kappa^2=2/3$  in nm

```

D.27 g_dyndom

`g_dyndom` reads a `.pdb` file output from DynDom (<http://www.cmp.uea.ac.uk/dyndom/>). It reads the coordinates, the coordinates of the rotation axis, and an index file containing the domains. Furthermore, it takes the first and last atom of the arrow file as command line arguments (head and tail) and finally it takes the translation vector (given in DynDom info file) and the angle of rotation (also as command line arguments). If the angle determined by DynDom is given, one should be able to recover the second structure used for generating the DynDom output. Because of limited numerical accuracy this should be verified by computing an all-atom RMSD (using `g_confirms`) rather than by file comparison (using `diff`).

The purpose of this program is to interpolate and extrapolate the rotation as found by DynDom. As a result unphysical structures with long or short bonds, or overlapping atoms may be produced. Visual inspection, and energy minimization may be necessary to validate the structure.

Files

-f	dyndom.pdb	Input	Protein data bank file
-o	rotated.xtc	Output	Trajectory: xtc trr trj gro g96 pdb
-n	domains.ndx	Input	Index file

Other options

```

    -h bool      no   Print help info and quit
  -version bool  no   Print version info and quit
    -nice  int    0   Set the nicelevel
-firstangle real  0   Angle of rotation about rotation vector
-lastangle real  0   Angle of rotation about rotation vector
  -nframe  int   11  Number of steps on the pathway
-maxangle  real  0   DymDom dtermined angle of rotation about rotation vector
  -trans  real  0   Translation (Angstrom) along rotation vector (see DynDom info file)
  -head vector 0 0 0 First atom of the arrow vector
  -tail vector 0 0 0 Last atom of the arrow vector

```

D.28 genbox

`genbox` can do one of 3 things:

1) Generate a box of solvent. Specify `-cs` and `-box`. Or specify `-cs` and `-cp` with a structure file with a box, but without atoms.

2) Solvate a solute configuration, e.g. a protein, in a bath of solvent molecules. Specify `-cp` (solute) and `-cs` (solvent). The box specified in the solute coordinate file (`-cp`) is used, unless `-box` is set. If you want the solute to be centered in the box, the program `editconf` has sophisticated options to change the box dimensions and center the solute. Solvent molecules are removed from the box where the distance between any atom of the solute molecule(s) and any atom of the solvent molecule is less than the sum of the van der Waals radii of both atoms. A database (`vdwradii.dat`) of van der Waals radii is read by the

program, and atoms not in the database are assigned a default distance `-vdwd`. Note that this option will also influence the distances between solvent molecules if they contain atoms that are not in the database.

3) Insert a number (`-nmol`) of extra molecules (`-ci`) at random positions. The program iterates until `nmol` molecules have been inserted in the box. To test whether an insertion is successful the same van der Waals criterium is used as for removal of solvent molecules. When no appropriately-sized holes (holes that can hold an extra molecule) are available, the program tries for `-nmol * -try` times before giving up. Increase `-try` if you have several small holes to fill.

If you need to do more than one of the above operations, it can be best to call `genbox` separately for each operation, so that you are sure of the order in which the operations occur.

The default solvent is Simple Point Charge water (SPC), with coordinates from `$GMXLIB/spc216.gro`. These coordinates can also be used for other 3-site water models, since a short equilibration will remove the small differences between the models. Other solvents are also supported, as well as mixed solvents. The only restriction to solvent types is that a solvent molecule consists of exactly one residue. The residue information in the coordinate files is used, and should therefore be more or less consistent. In practice this means that two subsequent solvent molecules in the solvent coordinate file should have different residue number. The box of solute is built by stacking the coordinates read from the coordinate file. This means that these coordinates should be equilibrated in periodic boundary conditions to ensure a good alignment of molecules on the stacking interfaces. The `-maxsol` option simply adds only the first `-maxsol` solvent molecules and leaves out the rest that would have fitted into the box. This can create a void that can cause problems later. Choose your volume wisely.

The program can optionally rotate the solute molecule to align the longest molecule axis along a box edge. This way the amount of solvent molecules necessary is reduced. It should be kept in mind that this only works for short simulations, as e.g. an alpha-helical peptide in solution can rotate over 90 degrees, within 500 ps. In general it is therefore better to make a more or less cubic box.

Setting `-shell` larger than zero will place a layer of water of the specified thickness (nm) around the solute. Hint: it is a good idea to put the protein in the center of a box first (using `editconf`).

Finally, `genbox` will optionally remove lines from your topology file in which a number of solvent molecules is already added, and adds a line with the total number of solvent molecules in your coordinate file.

Files

<code>-cp</code>	<code>protein.gro</code>	Input, Opt.	Structure file: gro g96 pdb tpr etc.
<code>-cs</code>	<code>spc216.gro</code>	Input, Opt., List	Structure file: gro g96 pdb tpr etc.
<code>-ci</code>	<code>insert.gro</code>	Input, Opt.	Structure file: gro g96 pdb tpr etc.
<code>-o</code>	<code>out.gro</code>	Output	Structure file: gro g96 pdb etc.
<code>-p</code>	<code>topol.top</code>	In/Out, Opt.	Topology file

Other options

<code>-h</code>	bool	no	Print help info and quit
<code>-version</code>	bool	no	Print version info and quit
<code>-nice</code>	int	19	Set the nicelevel
<code>-box</code>	vector	0 0 0	Box size
<code>-nmol</code>	int	0	Number of extra molecules to insert
<code>-try</code>	int	10	Try inserting <code>-nmol</code> times <code>-try</code> times
<code>-seed</code>	int	1997	Random generator seed
<code>-vdwd</code>	real	0.105	Default van der Waals distance
<code>-shell</code>	real	0	Thickness of optional water layer around solute
<code>-maxsol</code>	int	0	Maximum number of solvent molecules to add if they fit in the box. If zero (default) this is ignored
<code>-vel</code>	bool	no	Keep velocities from input solute and solvent

- Molecules must be whole in the initial configurations.

D.29 genconf

`genconf` multiplies a given coordinate file by simply stacking them on top of each other, like a small child playing with wooden blocks. The program makes a grid of *user-defined* proportions (`-nbox`), and interspaces the grid point with an extra space `-dist`.

When option `-rot` is used the program does not check for overlap between molecules on grid points. It is recommended to make the box in the input file at least as big as the coordinates + van der Waals radius.

If the optional trajectory file is given, conformations are not generated, but read from this file and translated appropriately to build the grid.

Files

<code>-f</code>	<code>conf.gro</code>	Input	Structure file: gro g96 pdb tpr etc.
<code>-o</code>	<code>out.gro</code>	Output	Structure file: gro g96 pdb etc.
<code>-trj</code>	<code>traj.xtc</code>	Input, Opt.	Trajectory: xtc trr trj gro g96 pdb cpt

Other options

<code>-h</code>	bool	no	Print help info and quit
<code>-version</code>	bool	no	Print version info and quit
<code>-nice</code>	int	0	Set the nicelevel
<code>-nbox</code>	vector	1 1 1	Number of boxes
<code>-dist</code>	vector	0 0 0	Distance between boxes
<code>-seed</code>	int	0	Random generator seed, if 0 generated from the time
<code>-rot</code>	bool	no	Randomly rotate conformations
<code>-shuffle</code>	bool	no	Random shuffling of molecules
<code>-sort</code>	bool	no	Sort molecules on X coord
<code>-block</code>	int	1	Divide the box in blocks on this number of cpus
<code>-nmolat</code>	int	3	Number of atoms per molecule, assumed to start from 0. If you set this wrong, it will screw up your system!
<code>-maxrot</code>	vector		
		180 180 180	Maximum random rotation
<code>-renumber</code>	bool	yes	Renumber residues

- The program should allow for random displacement of lattice points.

D.30 g_enemat

`g_enemat` extracts an energy matrix from the energy file (`-f`). With `-groups` a file must be supplied with on each line a group of atoms to be used. For these groups matrix of interaction energies will be extracted from the energy file by looking for energy groups with names corresponding to pairs of groups of atoms, e.g. if your `-groups` file contains:

```
2
Protein
SOL
```

then energy groups with names like 'Coul-SR:Protein-SOL' and 'LJ:Protein-SOL' are expected in the energy file (although `g_enemat` is most useful if many groups are analyzed simultaneously). Matrices for different energy types are written out separately, as controlled by the `-[no]coul`, `-[no]coulr`,

`-[no]coul14`, `-[no]lj`, `-[no]lj14`, `-[no]bham` and `-[no]free` options. Finally, the total interaction energy per group can be calculated (`-etot`).

An approximation of the free energy can be calculated using: $E_{free} = E_0 + kT \log(\langle \exp((E - E_0)/kT) \rangle)$, where ' $\langle \rangle$ ' stands for time-average. A file with reference free energies can be supplied to calculate the free energy difference with some reference state. Group names (e.g. residue names) in the reference file should correspond to the group names as used in the `-groups` file, but a appended number (e.g. residue number) in the `-groups` will be ignored in the comparison.

Files

<code>-f</code>	<code>ener.edr</code>	Input, Opt.	Energy file
<code>-groups</code>	<code>groups.dat</code>	Input	Generic data file
<code>-eref</code>	<code>eref.dat</code>	Input, Opt.	Generic data file
<code>-emat</code>	<code>emat.xpm</code>	Output	X PixMap compatible matrix file
<code>-etot</code>	<code>energy.xvg</code>	Output	xvgr/xmgr file

Other options

<code>-h</code>	bool	no	Print help info and quit
<code>-version</code>	bool	no	Print version info and quit
<code>-nice</code>	int	19	Set the nicelevel
<code>-b</code>	time	0	First frame (ps) to read from trajectory
<code>-e</code>	time	0	Last frame (ps) to read from trajectory
<code>-dt</code>	time	0	Only use frame when $t \text{ MOD } dt = \text{first time (ps)}$
<code>-w</code>	bool	no	View output <code>.xvg</code> , <code>.xpm</code> , <code>.eps</code> and <code>.pdb</code> files
<code>-xvg</code>	enum	<code>xmgrace</code>	xvg plot formatting: <code>xmgrace</code> , <code>xmgr</code> or <code>none</code>
<code>-sum</code>	bool	no	Sum the energy terms selected rather than display them all
<code>-skip</code>	int	0	Skip number of frames between data points
<code>-mean</code>	bool	yes	with <code>-groups</code> extracts matrix of mean energies instead of matrix for each timestep
<code>-nlevels</code>	int	20	number of levels for matrix colors
<code>-max</code>	real	<code>1e+20</code>	max value for energies
<code>-min</code>	real	<code>-1e+20</code>	min value for energies
<code>-coulsr</code>	bool	yes	extract Coulomb SR energies
<code>-coullr</code>	bool	no	extract Coulomb LR energies
<code>-coul14</code>	bool	no	extract Coulomb 1-4 energies
<code>-lj sr</code>	bool	yes	extract Lennard-Jones SR energies
<code>-lj lr</code>	bool	no	extract Lennard-Jones LR energies
<code>-lj 14</code>	bool	no	extract Lennard-Jones 1-4 energies
<code>-bhamsr</code>	bool	no	extract Buckingham SR energies
<code>-bhamlr</code>	bool	no	extract Buckingham LR energies
<code>-free</code>	bool	yes	calculate free energy
<code>-temp</code>	real	300	reference temperature for free energy calculation

D.31 *g_energy*

`g_energy` extracts energy components or distance restraint data from an energy file. The user is prompted to interactively select the desired energy terms.

Average, RMSD, and drift are calculated with full precision from the simulation (see printed manual). Drift is calculated by performing a least-squares fit of the data to a straight line. The reported total drift is the difference of the fit at the first and last point. An error estimate of the average is given based on a block averages over 5 blocks using the full-precision averages. The error estimate can be performed over multiple

block lengths with the options `-nbmin` and `-nbmax`. **Note** that in most cases the energy files contains averages over all MD steps, or over many more points than the number of frames in energy file. This makes the `g_energy` statistics output more accurate than the `.xvgr` output. When exact averages are not present in the energy file, the statistics mentioned above are simply over the single, per-frame energy values.

The term fluctuation gives the RMSD around the least-squares fit.

Some fluctuation-dependent properties can be calculated provided the correct energy terms are selected, and that the command line option `-fluct_props` is given. The following properties will be computed:

Property Energy terms needed

Heat capacity C_p (NPT sims): Enthalpy, Temp
 Heat capacity C_v (NVT sims): Etot, Temp
 Thermal expansion coeff. (NPT): Enthalpy, Vol, Temp
 Isothermal compressibility: Vol, Temp
 Adiabatic bulk modulus: Vol, Temp

You always need to set the number of molecules `-nmol`. The C_p/C_v computations do **not** include any corrections for quantum effects. Use the `g_dos` program if you need that (and you do).

When the `-viol` option is set, the time averaged violations are plotted and the running time-averaged and instantaneous sum of violations are recalculated. Additionally running time-averaged and instantaneous distances between selected pairs can be plotted with the `-pairs` option.

Options `-ora`, `-ort`, `-oda`, `-odr` and `-odt` are used for analyzing orientation restraint data. The first two options plot the orientation, the last three the deviations of the orientations from the experimental values. The options that end on an 'a' plot the average over time as a function of restraint. The options that end on a 't' prompt the user for restraint label numbers and plot the data as a function of time. Option `-odr` plots the RMS deviation as a function of restraint. When the run used time or ensemble averaged orientation restraints, option `-orinst` can be used to analyse the instantaneous, not ensemble-averaged orientations and deviations instead of the time and ensemble averages.

Option `-oten` plots the eigenvalues of the molecular order tensor for each orientation restraint experiment. With option `-ovec` also the eigenvectors are plotted.

Option `-odh` extracts and plots the free energy data (Hamiltonian differences and/or the Hamiltonian derivative `dhdl`) from the `ener.edr` file.

With `-fee` an estimate is calculated for the free-energy difference with an ideal gas state:

$$\Delta A = A(N,V,T) - A_{idealgas}(N,V,T) = kT \ln \langle \exp(U_{pot}/kT) \rangle$$

$$\Delta G = G(N,p,T) - G_{idealgas}(N,p,T) = kT \ln \langle \exp(U_{pot}/kT) \rangle$$

where k is Boltzmann's constant, T is set by `-fetemp` and the average is over the ensemble (or time in a trajectory). Note that this is in principle only correct when averaging over the whole (Boltzmann) ensemble and using the potential energy. This also allows for an entropy estimate using:

$$\Delta S(N,V,T) = S(N,V,T) - S_{idealgas}(N,V,T) = (\langle U_{pot} \rangle - \Delta A)/T$$

$$\Delta S(N,p,T) = S(N,p,T) - S_{idealgas}(N,p,T) = (\langle U_{pot} \rangle + pV - \Delta G)/T$$

When a second energy file is specified (`-f2`), a free energy difference is calculated

$dF = -kT \ln \langle \exp(-(E_B - E_A)/kT) \rangle_A$, where E_A and E_B are the energies from the first and second energy files, and the average is over the ensemble A . The running average of the free energy difference is printed to a file specified by `-ravg`. **Note** that the energies must both be calculated from the same trajectory.

Files

<code>-f</code>	<code>ener.edr</code>	Input	Energy file
<code>-f2</code>	<code>ener.edr</code>	Input, Opt.	Energy file
<code>-s</code>	<code>topol.tpr</code>	Input, Opt.	Run input file: tpr tpb tpa
<code>-o</code>	<code>energy.xvgr</code>	Output	xvgr/xmgr file

-viol	violaver.xvg	Output, Opt.	xvgr/xmgr file
-pairs	pairs.xvg	Output, Opt.	xvgr/xmgr file
-ora	orienta.xvg	Output, Opt.	xvgr/xmgr file
-ort	orientt.xvg	Output, Opt.	xvgr/xmgr file
-oda	orideva.xvg	Output, Opt.	xvgr/xmgr file
-odr	oridevr.xvg	Output, Opt.	xvgr/xmgr file
-odt	oridevt.xvg	Output, Opt.	xvgr/xmgr file
-oten	oriten.xvg	Output, Opt.	xvgr/xmgr file
-corr	enecorr.xvg	Output, Opt.	xvgr/xmgr file
-vis	visco.xvg	Output, Opt.	xvgr/xmgr file
-ravg	runavgdf.xvg	Output, Opt.	xvgr/xmgr file
-odh	dhdl.xvg	Output, Opt.	xvgr/xmgr file

Other options

-h	bool	no	Print help info and quit
-version	bool	no	Print version info and quit
-nice	int	19	Set the nicelevel
-b	time	0	First frame (ps) to read from trajectory
-e	time	0	Last frame (ps) to read from trajectory
-w	bool	no	View output .xvg, .xpm, .eps and .pdb files
-xvg	enum	xmgrace	xvg plot formatting: xmgrace, xmgr or none
-fee	bool	no	Do a free energy estimate
-fetemp	real	300	Reference temperature for free energy calculation
-zero	real	0	Subtract a zero-point energy
-sum	bool	no	Sum the energy terms selected rather than display them all
-dp	bool	no	Print energies in high precision
-nbmin	int	5	Minimum number of blocks for error estimate
-nbmax	int	5	Maximum number of blocks for error estimate
-mutot	bool	no	Compute the total dipole moment from the components
-skip	int	0	Skip number of frames between data points
-aver	bool	no	Also print the exact average and rmsd stored in the energy frames (only when 1 term is requested)
-nmol	int	1	Number of molecules in your sample: the energies are divided by this number
-fluct_props	bool	no	Compute properties based on energy fluctuations, like heat capacity
-driftcorr	bool	no	Useful only for calculations of fluctuation properties. The drift in the observables will be subtracted before computing the fluctuation properties.
-fluc	bool	no	Calculate autocorrelation of energy fluctuations rather than energy itself
-orinst	bool	no	Analyse instantaneous orientation data
-ovec	bool	no	Also plot the eigenvectors with -oten
-acflen	int	-1	Length of the ACF, default is half the number of frames
-normalize	bool	yes	Normalize ACF
-P	enum	0	Order of Legendre polynomial for ACF (0 indicates none): 0, 1, 2 or 3
-fitfn	enum	none	Fit function: none, exp, aexp, exp_exp, vac, exp5, exp7, exp9 or erffit
-ncskip	int	0	Skip this many points in the output file of correlation functions
-beginfit	real	0	Time where to begin the exponential fit of the correlation function
-endfit	real	-1	Time where to end the exponential fit of the correlation function, -1 is until the end

D.32 genion

`genion` replaces solvent molecules by monoatomic ions at the position of the first atoms with the most favorable electrostatic potential or at random. The potential is calculated on all atoms, using normal GRO-MACS particle-based methods (in contrast to other methods based on solving the Poisson-Boltzmann equation). The potential is recalculated after every ion insertion. If specified in the run input file, a reaction field, shift function or user function can be used. For the user function a table file can be specified with the option `-table`. The group of solvent molecules should be continuous and all molecules should have the same number of atoms. The user should add the ion molecules to the topology file or use the `-p` option to automatically modify the topology.

The ion molecule type, residue and atom names in all force fields are the capitalized element names without sign. This molecule name should be given with `-pname` or `-nname`, and the `[molecules]` section of your topology updated accordingly, either by hand or with `-p`. Do not use an atom name instead!

Ions which can have multiple charge states get the multiplicity added, without sign, for the uncommon states only.

With the option `-pot` the potential can be written as B-factors in a `.pdb` file (for visualisation using e.g. Rasmol). The unit of the potential is 1000 kJ/(mol e), the scaling be changed with the `-scale` option.

For larger ions, e.g. sulfate we recommended using `genbox`.

Files

<code>-s</code>	<code>topol.tpr</code>	Input	Run input file: tpr tpb tpa
<code>-table</code>	<code>table.xvg</code>	Input, Opt.	xvgr/xmgr file
<code>-n</code>	<code>index.ndx</code>	Input, Opt.	Index file
<code>-o</code>	<code>out.gro</code>	Output	Structure file: gro g96 pdb etc.
<code>-g</code>	<code>genion.log</code>	Output	Log file
<code>-pot</code>	<code>pot.pdb</code>	Output, Opt.	Protein data bank file
<code>-p</code>	<code>topol.top</code>	In/Out, Opt.	Topology file

Other options

<code>-h</code>	bool	no	Print help info and quit
<code>-version</code>	bool	no	Print version info and quit
<code>-nice</code>	int	19	Set the nicelevel
<code>-xvg</code>	enum	xmgrace	xvg plot formatting: xmgrace, xmgr or none
<code>-np</code>	int	0	Number of positive ions
<code>-pname</code>	string	NA	Name of the positive ion
<code>-pq</code>	int	1	Charge of the positive ion
<code>-nn</code>	int	0	Number of negative ions
<code>-nname</code>	string	CL	Name of the negative ion
<code>-nq</code>	int	-1	Charge of the negative ion
<code>-rmin</code>	real	0.6	Minimum distance between ions
<code>-random</code>	bool	yes	Use random placement of ions instead of based on potential. The <code>rmin</code> option should still work
<code>-seed</code>	int	1993	Seed for random number generator
<code>-scale</code>	real	0.001	Scaling factor for the potential for <code>-pot</code>
<code>-conc</code>	real	0	Specify salt concentration (mol/liter). This will add sufficient ions to reach up to the specified concentration as computed from the volume of the cell in the input <code>.tpr</code> file. Overrides the <code>-np</code> and <code>-nn</code> options.
<code>-neutral</code>	bool	no	This option will add enough ions to neutralize the system. These ions are added on top of those specified with <code>-np/-nn</code> or <code>-conc</code> .

- Calculation of the potential is not reliable, therefore the `-random` option is now turned on by default.

- If you specify a salt concentration existing ions are not taken into account. In effect you therefore specify the amount of salt to be added.

D.33 *genrestr*

genrestr produces an include file for a topology containing a list of atom numbers and three force constants for the *x*-, *y*-, and *z*-direction. A single isotropic force constant may be given on the command line instead of three components.

WARNING: position restraints only work for the one molecule at a time. Position restraints are interactions within molecules, therefore they should be included within the correct [*moleculetype*] block in the topology. Since the atom numbers in every *moleculetype* in the topology start at 1 and the numbers in the input file for *genrestr* number consecutively from 1, *genrestr* will only produce a useful file for the first molecule.

The *-of* option produces an index file that can be used for freezing atoms. In this case, the input file must be a *.pdb* file.

With the *-disre* option, half a matrix of distance restraints is generated instead of position restraints. With this matrix, that one typically would apply to *C α* atoms in a protein, one can maintain the overall conformation of a protein without tying it to a specific position (as with position restraints).

Files

<i>-f</i>	<i>conf.gro</i>	Input	Structure file: <i>gro g96 pdb tpr</i> etc.
<i>-n</i>	<i>index.ndx</i>	Input, Opt.	Index file
<i>-o</i>	<i>posre.itp</i>	Output	Include file for topology
<i>-of</i>	<i>freeze.ndx</i>	Output, Opt.	Index file

Other options

<i>-h</i>	bool	no	Print help info and quit
<i>-version</i>	bool	no	Print version info and quit
<i>-nice</i>	int	0	Set the nicelevel
<i>-fc</i>	vector		
	1000 1000 1000		Force constants (kJ/mol nm ²)
<i>-freeze</i>	real	0	If the <i>-of</i> option or this one is given an index file will be written containing atom numbers of all atoms that have a B-factor less than the level given here
<i>-disre</i>	bool	no	Generate a distance restraint matrix for all the atoms in index
<i>-disre_dist</i>	real	0.1	Distance range around the actual distance for generating distance restraints
<i>-disre_frac</i>	real	0	Fraction of distance to be used as interval rather than a fixed distance. If the fraction of the distance that you specify here is less than the distance given in the previous option, that one is used instead.
<i>-disre_up2</i>	real	1	Distance between upper bound for distance restraints, and the distance at which the force becomes constant (see manual)
<i>-cutoff</i>	real	-1	Only generate distance restraints for atoms pairs within cutoff (nm)
<i>-constr</i>	bool	no	Generate a constraint matrix rather than distance restraints. Constraints of type 2 will be generated that do generate exclusions.

D.34 *g_filter*

g_filter performs frequency filtering on a trajectory. The filter shape is $\cos(\pi t/A) + 1$ from $-A$ to $+A$, where A is given by the option *-nf* times the time step in the input trajectory. This filter reduces

fluctuations with period A by 85%, with period $2*A$ by 50% and with period $3*A$ by 17% for low-pass filtering. Both a low-pass and high-pass filtered trajectory can be written.

Option `-ol` writes a low-pass filtered trajectory. A frame is written every `-nf` input frames. This ratio of filter length and output interval ensures a good suppression of aliasing of high-frequency motion, which is useful for making smooth movies. Also averages of properties which are linear in the coordinates are preserved, since all input frames are weighted equally in the output. When all frames are needed, use the `-all` option.

Option `-oh` writes a high-pass filtered trajectory. The high-pass filtered coordinates are added to the coordinates from the structure file. When using high-pass filtering use `-fit` or make sure you use a trajectory that has been fitted on the coordinates in the structure file.

Files

<code>-f</code>	<code>traj.xtc</code>	Input	Trajectory: xtc trr trj gro g96 pdb cpt
<code>-s</code>	<code>topol.tpr</code>	Input, Opt.	Structure+mass(db): tpr tpb tpa gro g96 pdb
<code>-n</code>	<code>index.ndx</code>	Input, Opt.	Index file
<code>-ol</code>	<code>lowpass.xtc</code>	Output, Opt.	Trajectory: xtc trr trj gro g96 pdb
<code>-oh</code>	<code>highpass.xtc</code>	Output, Opt.	Trajectory: xtc trr trj gro g96 pdb

Other options

<code>-h</code>	bool	no	Print help info and quit
<code>-version</code>	bool	no	Print version info and quit
<code>-nice</code>	int	19	Set the nicelevel
<code>-b</code>	time	0	First frame (ps) to read from trajectory
<code>-e</code>	time	0	Last frame (ps) to read from trajectory
<code>-dt</code>	time	0	Only use frame when $t \text{ MOD } dt = \text{first time (ps)}$
<code>-w</code>	bool	no	View output <code>.xvg</code> , <code>.xpm</code> , <code>.eps</code> and <code>.pdb</code> files
<code>-nf</code>	int	10	Sets the filter length as well as the output interval for low-pass filtering
<code>-all</code>	bool	no	Write all low-pass filtered frames
<code>-nojump</code>	bool	yes	Remove jumps of atoms across the box
<code>-fit</code>	bool	no	Fit all frames to a reference structure

D.35 g_gyrate

`g_gyrate` computes the radius of gyration of a molecule and the radii of gyration about the x -, y - and z -axes, as a function of time. The atoms are explicitly mass weighted.

With the `-nmol` option the radius of gyration will be calculated for multiple molecules by splitting the analysis group in equally sized parts.

With the option `-nz` 2D radii of gyration in the x - y plane of slices along the z -axis are calculated.

Files

<code>-f</code>	<code>traj.xtc</code>	Input	Trajectory: xtc trr trj gro g96 pdb cpt
<code>-s</code>	<code>topol.tpr</code>	Input	Structure+mass(db): tpr tpb tpa gro g96 pdb
<code>-n</code>	<code>index.ndx</code>	Input, Opt.	Index file
<code>-o</code>	<code>gyrate.xvg</code>	Output	xvgr/xmgr file
<code>-acf</code>	<code>moi-acf.xvg</code>	Output, Opt.	xvgr/xmgr file

Other options

<code>-h</code>	bool	no	Print help info and quit
<code>-version</code>	bool	no	Print version info and quit
<code>-nice</code>	int	19	Set the nicelevel

-b	time	0	First frame (ps) to read from trajectory
-e	time	0	Last frame (ps) to read from trajectory
-dt	time	0	Only use frame when $t \text{ MOD } dt = \text{first time (ps)}$
-w	bool	no	View output .xvg, .xpm, .eps and .pdb files
-xvg	enum	xmgrace	xvg plot formatting: xmgrace, xmgr or none
-nmol	int	1	The number of molecules to analyze
-q	bool	no	Use absolute value of the charge of an atom as weighting factor instead of mass
-p	bool	no	Calculate the radii of gyration about the principal axes.
-moi	bool	no	Calculate the moments of inertia (defined by the principal axes).
-nz	int	0	Calculate the 2D radii of gyration of this number of slices along the z-axis
-acflen	int	-1	Length of the ACF, default is half the number of frames
-normalize	bool	yes	Normalize ACF
-P	enum	0	Order of Legendre polynomial for ACF (0 indicates none): 0, 1, 2 or 3
-fitfn	enum	none	Fit function: none, exp, aexp, exp_exp, vac, exp5, exp7, exp9 or erffit
-ncskip	int	0	Skip this many points in the output file of correlation functions
-beginfit	real	0	Time where to begin the exponential fit of the correlation function
-endfit	real	-1	Time where to end the exponential fit of the correlation function, -1 is until the end

D.36 *g_h2order*

g_h2order computes the orientation of water molecules with respect to the normal of the box. The program determines the average cosine of the angle between the dipole moment of water and an axis of the box. The box is divided in slices and the average orientation per slice is printed. Each water molecule is assigned to a slice, per time frame, based on the position of the oxygen. When *-nm* is used, the angle between the water dipole and the axis from the center of mass to the oxygen is calculated instead of the angle between the dipole and a box axis.

Files

-f	traj.xtc	Input	Trajectory: xtc trr trj gro g96 pdb cpt
-n	index.ndx	Input	Index file
-nm	index.ndx	Input, Opt.	Index file
-s	topol.tpr	Input	Run input file: tpr tpb tpa
-o	order.xvg	Output	xvgr/xmgr file

Other options

-h	bool	no	Print help info and quit
-version	bool	no	Print version info and quit
-nice	int	19	Set the nicelevel
-b	time	0	First frame (ps) to read from trajectory
-e	time	0	Last frame (ps) to read from trajectory
-dt	time	0	Only use frame when $t \text{ MOD } dt = \text{first time (ps)}$
-w	bool	no	View output .xvg, .xpm, .eps and .pdb files
-xvg	enum	xmgrace	xvg plot formatting: xmgrace, xmgr or none
-d	string	Z	Take the normal on the membrane in direction X, Y or Z.
-sl	int	0	Calculate order parameter as function of boxlength, dividing the box in this number of slices.

- The program assigns whole water molecules to a slice, based on the first atom of three in the index file group. It assumes an order O,H,H. Name is not important, but the order is. If this demand is not met, assigning molecules to slices is different.

D.37 g_hbond

g_hbond computes and analyzes hydrogen bonds. Hydrogen bonds are determined based on cutoffs for the angle Hydrogen - Donor - Acceptor (zero is extended) and the distance Donor - Acceptor (or Hydrogen - Acceptor using `-noda`). OH and NH groups are regarded as donors, O is an acceptor always, N is an acceptor by default, but this can be switched using `-nitacc`. Dummy hydrogen atoms are assumed to be connected to the first preceding non-hydrogen atom.

You need to specify two groups for analysis, which must be either identical or non-overlapping. All hydrogen bonds between the two groups are analyzed.

If you set `-shell`, you will be asked for an additional index group which should contain exactly one atom. In this case, only hydrogen bonds between atoms within the shell distance from the one atom are considered.

With option `-ac`, rate constants for hydrogen bonding can be derived with the model of Luzar and Chandler (Nature 394, 1996; J. Chem. Phys. 113:23, 2000) or that of Markovitz and Agmon (J. Chem. Phys 129, 2008). If contact kinetics are analyzed by using the `-contact` option, then $n(t)$ can be defined as either all pairs that are not within contact distance r at time t (corresponding to leaving the `-r2` option at the default value 0) or all pairs that are within distance $r2$ (corresponding to setting a second cut-off value with option `-r2`). See mentioned literature for more details and definitions.

```
[ selected ]
20 21 24
25 26 29
1 3 6
```

Note that the triplets need not be on separate lines. Each atom triplet specifies a hydrogen bond to be analyzed, note also that no check is made for the types of atoms.

Output:

- `-num`: number of hydrogen bonds as a function of time.
- `-ac`: average over all autocorrelations of the existence functions (either 0 or 1) of all hydrogen bonds.
- `-dist`: distance distribution of all hydrogen bonds.
- `-ang`: angle distribution of all hydrogen bonds.
- `-hx`: the number of n - $n+i$ hydrogen bonds as a function of time where n and $n+i$ stand for residue numbers and i ranges from 0 to 6. This includes the n - $n+3$, n - $n+4$ and n - $n+5$ hydrogen bonds associated with helices in proteins.
- `-hbn`: all selected groups, donors, hydrogens and acceptors for selected groups, all hydrogen bonded atoms from all groups and all solvent atoms involved in insertion.
- `-hbm`: existence matrix for all hydrogen bonds over all frames, this also contains information on solvent insertion into hydrogen bonds. Ordering is identical to that in `-hbn` index file.
- `-dan`: write out the number of donors and acceptors analyzed for each timeframe. This is especially useful when using `-shell`.
- `-nhbdist`: compute the number of HBonds per hydrogen in order to compare results to Raman Spectroscopy.

Note: options `-ac`, `-life`, `-hbn` and `-hbm` require an amount of memory proportional to the total numbers of donors times the total number of acceptors in the selected group(s).

Files

<code>-f</code>	<code>traj.xtc</code>	Input	Trajectory: xtc trr trj gro g96 pdb cpt
<code>-s</code>	<code>topol.tpr</code>	Input	Run input file: tpr tpb tpa
<code>-n</code>	<code>index.ndx</code>	Input, Opt.	Index file
<code>-num</code>	<code>hbnum.xvg</code>	Output	xvgr/xmgr file
<code>-g</code>	<code>hbond.log</code>	Output, Opt.	Log file

-ac	hbac.xvg	Output, Opt.	xvgr/xmgr file
-dist	hbdist.xvg	Output, Opt.	xvgr/xmgr file
-ang	hbang.xvg	Output, Opt.	xvgr/xmgr file
-hx	hbhelix.xvg	Output, Opt.	xvgr/xmgr file
-hbn	hbond.ndx	Output, Opt.	Index file
-hbm	hbmap.xpm	Output, Opt.	X PixMap compatible matrix file
-don	donor.xvg	Output, Opt.	xvgr/xmgr file
-dan	danum.xvg	Output, Opt.	xvgr/xmgr file
-life	hblife.xvg	Output, Opt.	xvgr/xmgr file
-nhbdist	nhbdist.xvg	Output, Opt.	xvgr/xmgr file

Other options

-h	bool	no	Print help info and quit
-version	bool	no	Print version info and quit
-nice	int	19	Set the nicelevel
-b	time	0	First frame (ps) to read from trajectory
-e	time	0	Last frame (ps) to read from trajectory
-dt	time	0	Only use frame when $t \text{ MOD } dt = \text{first time (ps)}$
-tu	enum	ps	Time unit: fs, ps, ns, us, ms or s
-xvg	enum	xmgrace	xvg plot formatting: xmgrace, xmgr or none
-a	real	30	Cutoff angle (degrees, Hydrogen - Donor - Acceptor)
-r	real	0.35	Cutoff radius (nm, X - Acceptor, see next option)
-da	bool	yes	Use distance Donor-Acceptor (if TRUE) or Hydrogen-Acceptor (FALSE)
-r2	real	0	Second cutoff radius. Mainly useful with <code>-contact</code> and <code>-ac</code>
-abin	real	1	Binwidth angle distribution (degrees)
-rbin	real	0.005	Binwidth distance distribution (nm)
-nitacc	bool	yes	Regard nitrogen atoms as acceptors
-contact	bool	no	Do not look for hydrogen bonds, but merely for contacts within the cut-off distance
-shell	real	-1	when > 0 , only calculate hydrogen bonds within # nm shell around one particle
-fitstart	real	1	Time (ps) from which to start fitting the correlation functions in order to obtain the forward and backward rate constants for HB breaking and formation. With <code>-gemfit</code> we suggest <code>-fitstart 0</code>
-fitstart	real	1	Time (ps) to which to stop fitting the correlation functions in order to obtain the forward and backward rate constants for HB breaking and formation (only with <code>-gemfit</code>)
-temp	real	298.15	Temperature (K) for computing the Gibbs energy corresponding to HB breaking and reforming
-smooth	real	-1	If ≥ 0 , the tail of the ACF will be smoothed by fitting it to an exponential function: $y = A \exp(-x/\tau)$
-dump	int	0	Dump the first N hydrogen bond ACFs in a single .xvg file for debugging
-max_hb	real	0	Theoretical maximum number of hydrogen bonds used for normalizing HB autocorrelation function. Can be useful in case the program estimates it wrongly
-merge	bool	yes	H-bonds between the same donor and acceptor, but with different hydrogen are treated as a single H-bond. Mainly important for the ACF.
-geminate	enum	none	Use reversible geminate recombination for the kinetics/thermodynamics calculations. See Markovitch et al., J. Chem. Phys 129, 084505 (2008) for details.: none, dd, ad, aa or a4
-diff	real	-1	Dffusion coefficient to use in the reversible geminate recombination kinetic model. If negative, then it will be fitted to the ACF along with ka and kd.

-acflen	int	-1	Length of the ACF, default is half the number of frames
-normalize	bool	yes	Normalize ACF
-P	enum	0	Order of Legendre polynomial for ACF (0 indicates none): 0, 1, 2 or 3
-fitfn	enum	none	Fit function: none, exp, aexp, exp_exp, vac, exp5, exp7, exp9 or erffit
-ncskip	int	0	Skip this many points in the output file of correlation functions
-beginfit	real	0	Time where to begin the exponential fit of the correlation function
-endfit	real	-1	Time where to end the exponential fit of the correlation function, -1 is until the end

- The option `-sel` that used to work on selected hbonds is out of order, and therefore not available for the time being.

D.38 g_helix

`g_helix` computes all kinds of helix properties. First, the peptide is checked to find the longest helical part, as determined by hydrogen bonds and ϕ/ψ angles. That bit is fitted to an ideal helix around the z -axis and centered around the origin. Then the following properties are computed:

1. Helix radius (file `radius.xvg`). This is merely the RMS deviation in two dimensions for all $C\alpha$ atoms. it is calculated as $\sqrt{(\sum_i(x^2(i) + y^2(i)))/N}$ where N is the number of backbone atoms. For an ideal helix the radius is 0.23 nm
2. Twist (file `twist.xvg`). The average helical angle per residue is calculated. For an α -helix it is 100 degrees, for 3-10 helices it will be smaller, and for 5-helices it will be larger.
3. Rise per residue (file `rise.xvg`). The helical rise per residue is plotted as the difference in z -coordinate between $C\alpha$ atoms. For an ideal helix, this is 0.15 nm
4. Total helix length (file `len-ahx.xvg`). The total length of the helix in nm. This is simply the average rise (see above) times the number of helical residues (see below).
5. Helix dipole, backbone only (file `dip-ahx.xvg`).
6. RMS deviation from ideal helix, calculated for the $C\alpha$ atoms only (file `rms-ahx.xvg`).
7. Average $C\alpha - C\alpha$ dihedral angle (file `phi-ahx.xvg`).
8. Average ϕ and ψ angles (file `phipsi.xvg`).
9. Ellipticity at 222 nm according to Hirst and Brooks.

Files

-s	<code>topol.tpr</code>	Input	Run input file: tpr tpb tpa
-n	<code>index.ndx</code>	Input	Index file
-f	<code>traj.xtc</code>	Input	Trajectory: xtc trr trj gro g96 pdb cpt
-to	<code>gtraj.g87</code>	Output, Opt.	Gromos-87 ASCII trajectory format
-cz	<code>zconf.gro</code>	Output	Structure file: gro g96 pdb etc.
-co	<code>waver.gro</code>	Output	Structure file: gro g96 pdb etc.

Other options

-h	bool	no	Print help info and quit
-version	bool	no	Print version info and quit
-nice	int	19	Set the nicelevel
-b	time	0	First frame (ps) to read from trajectory
-e	time	0	Last frame (ps) to read from trajectory
-dt	time	0	Only use frame when $t \text{ MOD } dt = \text{first time (ps)}$
-w	bool	no	View output <code>.xvg</code> , <code>.xpm</code> , <code>.eps</code> and <code>.pdb</code> files
-r0	int	1	The first residue number in the sequence
-q	bool	no	Check at every step which part of the sequence is helical

-F	bool	yes	Toggle fit to a perfect helix
-db	bool	no	Print debug info
-prop	enum	RAD	Select property to weight eigenvectors with. WARNING experimental stuff: RAD, TWIST, RISE, LEN, NHX, DIP, RMS, CPHI, RMSA, PHI, PSI, HB3, HB4, HB5 or CD222
-ev	bool	no	Write a new 'trajectory' file for ED
-ahxstart	int	0	First residue in helix
-ahxend	int	0	Last residue in helix

D.39 *g_helixorient*

g_helixorient calculates the coordinates and direction of the average axis inside an alpha helix, and the direction/vectors of both the $C\alpha$ and (optionally) a sidechain atom relative to the axis.

As input, you need to specify an index group with $C\alpha$ atoms corresponding to an α -helix of continuous residues. Sidechain directions require a second index group of the same size, containing the heavy atom in each residue that should represent the sidechain.

Note that this program does not do any fitting of structures.

We need four $C\alpha$ coordinates to define the local direction of the helix axis.

The tilt/rotation is calculated from Euler rotations, where we define the helix axis as the local x -axis, the residues/ $C\alpha$ vector as y , and the z -axis from their cross product. We use the Euler Y-Z-X rotation, meaning we first tilt the helix axis (1) around and (2) orthogonal to the residues vector, and finally apply the (3) rotation around it. For debugging or other purposes, we also write out the actual Euler rotation angles as `theta[1-3].xvg`

Files

-s	topol.tpr	Input	Run input file: tpr tpb tpa
-f	traj.xtc	Input	Trajectory: xtc trr trj gro g96 pdb cpt
-n	index.ndx	Input, Opt.	Index file
-oaxis	helixaxis.dat	Output	Generic data file
-ocenter	center.dat	Output	Generic data file
-orise	rise.xvg	Output	xvgr/xmgr file
-oradius	radius.xvg	Output	xvgr/xmgr file
-otwist	twist.xvg	Output	xvgr/xmgr file
-obending	bending.xvg	Output	xvgr/xmgr file
-otilt	tilt.xvg	Output	xvgr/xmgr file
-orot	rotation.xvg	Output	xvgr/xmgr file

Other options

-h	bool	no	Print help info and quit
-version	bool	no	Print version info and quit
-nice	int	19	Set the nicelevel
-b	time	0	First frame (ps) to read from trajectory
-e	time	0	Last frame (ps) to read from trajectory
-dt	time	0	Only use frame when $t \text{ MOD } dt = \text{first time (ps)}$
-xvg	enum	xmgrace	xvg plot formatting: xmgrace, xmgr or none
-sidechain	bool	no	Calculate sidechain directions relative to helix axis too.
-incremental	bool	no	Calculate incremental rather than total rotation/tilt.

D.40 g_hydorder

`g_hydorder` computes the tetrahedrality order parameters around a given atom. Both angle and distance order parameters are calculated. See P.-L. Chau and A.J. Hardwick, *Mol. Phys.*, 93, (1998), 511-518. for more details.

This application calculates the order parameter in a 3d-mesh in the box, and with 2 phases in the box gives the user the option to define a 2D interface in time separating the faces by specifying parameters `-sgang1` and `-sgang2` (It is important to select these judiciously)

Files

<code>-f</code>	<code>traj.xtc</code>	Input	Trajectory: xtc trr trj gro g96 pdb cpt
<code>-n</code>	<code>index.ndx</code>	Input	Index file
<code>-s</code>	<code>topol.tpr</code>	Input	Run input file: tpr tpb tpa
<code>-o</code>	<code>intf.xpm</code>	Output, Mult.	X PixMap compatible matrix file
<code>-or</code>	<code>raw.out</code>	Output, Opt., Mult.	Raw output file
<code>-spect</code>	<code>intfspect.out</code>	Output, Opt., Mult.	Spectral output file

Other options

<code>-h</code>	bool	no	Print help info and quit
<code>-version</code>	bool	no	Print version info and quit
<code>-nice</code>	int	19	Set the nicelevel
<code>-b</code>	time	0	First frame (ps) to read from trajectory
<code>-e</code>	time	0	Last frame (ps) to read from trajectory
<code>-dt</code>	time	0	Only use frame when $t \text{ MOD } dt = \text{first time (ps)}$
<code>-w</code>	bool	no	View output <code>.xvg</code> , <code>.xpm</code> , <code>.eps</code> and <code>.pdb</code> files
<code>-d</code>	enum	z	Direction of the normal on the membrane: z, x or y
<code>-bw</code>	real	1	Binwidth of box mesh
<code>-sgang1</code>	real	1	tetrahedral angle parameter in Phase 1 (bulk)
<code>-sgang2</code>	real	1	tetrahedral angle parameter in Phase 2 (bulk)
<code>-tblock</code>	int	1	Number of frames in one time-block average
<code>-nlevel</code>	int	100	Number of Height levels in 2D - XPixMaps

D.41 g_kinetics

`g_kinetics` reads two `.xvg` files, each one containing data for N replicas. The first file contains the temperature of each replica at each timestep, and the second contains real values that can be interpreted as an indicator for folding. If the value in the file is larger than the cutoff it is taken to be unfolded and the other way around.

From these data an estimate of the forward and backward rate constants for folding is made at a reference temperature. In addition, a theoretical melting curve and free energy as a function of temperature are printed in an `.xvg` file.

The user can give a max value to be regarded as intermediate (`-ucut`), which, when given will trigger the use of an intermediate state in the algorithm to be defined as those structures that have $\text{cutoff} < \text{DATA} < \text{ucut}$. Structures with DATA values larger than `ucut` will not be regarded as potential folders. In this case 8 parameters are optimized.

The average fraction folded is printed in an `.xvg` file together with the fit to it. If an intermediate is used a further file will show the build of the intermediate and the fit to that process.

The program can also be used with continuous variables (by setting `-nodiscrete`). In this case kinetics of other processes can be studied. This is very much a work in progress and hence the manual (this information) is lagging behind somewhat.

In order to compile this program you need access to the GNU scientific library.

Files

-f	temp.xvg	Input	xvgr/xmgr file
-d	data.xvg	Input	xvgr/xmgr file
-d2	data2.xvg	Input, Opt.	xvgr/xmgr file
-o	ft_all.xvg	Output	xvgr/xmgr file
-o2	it_all.xvg	Output, Opt.	xvgr/xmgr file
-o3	ft_repl.xvg	Output, Opt.	xvgr/xmgr file
-ee	err_est.xvg	Output, Opt.	xvgr/xmgr file
-g	remd.log	Output	Log file
-m	melt.xvg	Output	xvgr/xmgr file

Other options

-h	bool	no	Print help info and quit
-version	bool	no	Print version info and quit
-nice	int	19	Set the nicelevel
-tu	enum	ps	Time unit: fs, ps, ns, us, ms or s
-w	bool	no	View output .xvg, .xpm, .eps and .pdb files
-xvg	enum	xmgrace	xvg plot formatting: xmgrace, xmgr or none
-time	bool	yes	Expect a time in the input
-b	real	0	First time to read from set
-e	real	0	Last time to read from set
-bfit	real	-1	Time to start the fit from
-efit	real	-1	Time to end the fit
-T	real	298.15	Reference temperature for computing rate constants
-n	int	1	Read data for this number of replicas. Only necessary when files are written in xmgrace format using @type and & as delimiters.
-cut	real	0.2	Cut-off (max) value for regarding a structure as folded
-ucut	real	0	Cut-off (max) value for regarding a structure as intermediate (if not folded)
-euf	real	10	Initial guess for energy of activation for folding (kJ/mol)
-efu	real	30	Initial guess for energy of activation for unfolding (kJ/mol)
-ei	real	10	Initial guess for energy of activation for intermediates (kJ/mol)
-maxiter	int	100	Max number of iterations
-back	bool	yes	Take the back reaction into account
-tol	real	0.001	Absolute tolerance for convergence of the Nelder and Mead simplex algorithm
-skip	int	0	Skip points in the output .xvg file
-split	bool	yes	Estimate error by splitting the number of replicas in two and refitting
-sum	bool	yes	Average folding before computing χ^2
-discrete	bool	yes	Use a discrete folding criterion (F <-> U) or a continuous one
-mult	int	1	Factor to multiply the data with before discretization

D.42 *g_lie*

g_lie computes a free energy estimate based on an energy analysis from. One needs an energy file with the following components: Coul (A-B) LJ-SR (A-B) etc.

Files

-f	ener.edr	Input	Energy file
-o	lie.xvg	Output	xvgr/xmgr file

Other options

-h	bool	no	Print help info and quit
-version	bool	no	Print version info and quit
-nice	int	19	Set the nicelevel
-b	time	0	First frame (ps) to read from trajectory
-e	time	0	Last frame (ps) to read from trajectory
-dt	time	0	Only use frame when $t \text{ MOD } dt = \text{first time (ps)}$
-w	bool	no	View output .xvg, .xpm, .eps and .pdb files
-xvg	enum	xmgrace	xvg plot formatting: xmgrace, xmgr or none
-E1j	real	0	Lennard-Jones interaction between ligand and solvent
-Eqq	real	0	Coulomb interaction between ligand and solvent
-C1j	real	0.181	Factor in the LIE equation for Lennard-Jones component of energy
-Cqq	real	0.5	Factor in the LIE equation for Coulomb component of energy
-ligand	string	none	Name of the ligand in the energy file

D.43 g_mdmat

`g_mdmat` makes distance matrices consisting of the smallest distance between residue pairs. With `-frames`, these distance matrices can be stored in order to see differences in tertiary structure as a function of time. If you choose your options unwisely, this may generate a large output file. By default, only an averaged matrix over the whole trajectory is output. Also a count of the number of different atomic contacts between residues over the whole trajectory can be made. The output can be processed with `xpm2ps` to make a PostScript (tm) plot.

Files

-f	traj.xtc	Input	Trajectory: xtc trr trj gro g96 pdb cpt
-s	topol.tpr	Input	Structure+mass(db): tpr tpb tpa gro g96 pdb
-n	index.ndx	Input, Opt.	Index file
-mean	dm.xpm	Output	X PixMap compatible matrix file
-frames	dmf.xpm	Output, Opt.	X PixMap compatible matrix file
-no	num.xvg	Output, Opt.	xvgr/xmgr file

Other options

-h	bool	no	Print help info and quit
-version	bool	no	Print version info and quit
-nice	int	19	Set the nicelevel
-b	time	0	First frame (ps) to read from trajectory
-e	time	0	Last frame (ps) to read from trajectory
-dt	time	0	Only use frame when $t \text{ MOD } dt = \text{first time (ps)}$
-xvg	enum	xmgrace	xvg plot formatting: xmgrace, xmgr or none
-t	real	1.5	trunc distance
-nlevels	int	40	Discretize distance in this number of levels

D.44 g_membed

`g_membed` embeds a membrane protein into an equilibrated lipid bilayer at the position and orientation specified by the user.

SHORT MANUAL

The user should merge the structure files of the protein and membrane (+solvent), creating a single structure file with the protein overlapping the membrane at the desired position and orientation. The box size is taken from the membrane structure file. The corresponding topology files should also be merged. Consecutively, create a `.tpr` file (input for `g_membed`) from these files, with the following options included in the `.mdp` file.

```
-integrator = md
-energygrp = Protein (or other group that you want to insert)
-freeze-grps = Protein
-freezedim = Y Y Y
-energygrp_excl = Protein Protein
```

The output is a structure file containing the protein embedded in the membrane. If a topology file is provided, the number of lipid and solvent molecules will be updated to match the new structure file.

For a more extensive manual see Wolf et al, *J Comp Chem* 31 (2010) 2169-2174, Appendix.

SHORT METHOD DESCRIPTION

1. The protein is resized around its center of mass by a factor $-xy$ in the xy -plane (the membrane plane) and a factor $-z$ in the z -direction (if the size of the protein in the z -direction is the same or smaller than the width of the membrane, a $-z$ value larger than 1 can prevent that the protein will be enveloped by the lipids).
2. All lipid and solvent molecules overlapping with the resized protein are removed. All intraprotein interactions are turned off to prevent numerical issues for small values of $-xy$ or $-z$.
3. One md step is performed.
4. The resize factor ($-xy$ or $-z$) is incremented by a small amount ($(1-xy)/nxy$ or $(1-z)/nz$) and the protein is resized again around its center of mass. The resize factor for the xy -plane is incremented first. The resize factor for the z -direction is not changed until the $-xy$ factor is 1 (thus after $-nxy$ iterations).
5. Repeat step 3 and 4 until the protein reaches its original size ($-nxy + -nz$ iterations).

For a more extensive method description see Wolf et al, *J Comp Chem*, 31 (2010) 2169-2174.

NOTE

- Protein can be any molecule you want to insert in the membrane.
- It is recommended to perform a short equilibration run after the embedding (see Wolf et al, *J Comp Chem* 31 (2010) 2169-2174), to re-equilibrate the membrane. Clearly protein equilibration might require longer.

Files

<code>-f</code>	<code>into_mem.tpr</code>	Input	Run input file: tpr tpb tpa
<code>-n</code>	<code>index.ndx</code>	Input, Opt.	Index file
<code>-p</code>	<code>topol.top</code>	In/Out, Opt.	Topology file
<code>-o</code>	<code>traj.trr</code>	Output	Full precision trajectory: tr trj cpt
<code>-x</code>	<code>traj.xtc</code>	Output, Opt.	Compressed trajectory (portable xdr format)
<code>-c</code>	<code>membedded.gro</code>	Output	Structure file: gro g96 pdb etc.
<code>-e</code>	<code>ener.edr</code>	Output	Energy file
<code>-dat</code>	<code>membed.dat</code>	Output	Generic data file

Other options

<code>-h</code>	bool	no	Print help info and quit
<code>-version</code>	bool	no	Print version info and quit
<code>-nice</code>	int	0	Set the nicelevel
<code>-xyinit</code>	real	0.5	Resize factor for the protein in the xy dimension before starting embedding
<code>-xyend</code>	real	1	Final resize factor in the xy dimension
<code>-zinit</code>	real	1	Resize factor for the protein in the z dimension before starting embedding
<code>-zend</code>	real	1	Final resize fraction in the z dimension

-nxy	int	1000	Number of iteration for the xy dimension
-nz	int	0	Number of iterations for the z dimension
-rad	real	0.22	Probe radius to check for overlap between the group to embed and the membrane
-pieces	int	1	Perform piecewise resize. Select parts of the group to insert and resize these with respect to their own geometrical center.
-asymmetry	bool	no	Allow asymmetric insertion, i.e. the number of lipids removed from the upper and lower leaflet will not be checked.
-ndiff	int	0	Number of lipids that will additionally be removed from the lower (negative number) or upper (positive number) membrane leaflet.
-maxwarn	int	0	Maximum number of warning allowed
-start	bool	no	Call mdrun with membed options
-v	bool	no	Be loud and noisy
-mdrun_path	string		Path to the mdrun executable compiled with this g_membed version

D.45 g_mindist

`g_mindist` computes the distance between one group and a number of other groups. Both the minimum distance (between any pair of atoms from the respective groups) and the number of contacts within a given distance are written to two separate output files. With the `-group` option a contact of an atom in another group with multiple atoms in the first group is counted as one contact instead of as multiple contacts. With `-or`, minimum distances to each residue in the first group are determined and plotted as a function of residue number.

With option `-pi` the minimum distance of a group to its periodic image is plotted. This is useful for checking if a protein has seen its periodic image during a simulation. Only one shift in each direction is considered, giving a total of 26 shifts. It also plots the maximum distance within the group and the lengths of the three box vectors.

Other programs that calculate distances are `g_dist` and `g_bond`.

Files

-f	traj.xtc	Input	Trajectory: xtc trr trj gro g96 pdb cpt
-s	topol.tpr	Input, Opt.	Structure+mass(db): tpr tpb tpa gro g96 pdb
-n	index.ndx	Input, Opt.	Index file
-od	mindist.xvg	Output	xvgr/xmgr file
-on	numcont.xvg	Output, Opt.	xvgr/xmgr file
-o	atm-pair.out	Output, Opt.	Generic output file
-ox	mindist.xtc	Output, Opt.	Trajectory: xtc trr trj gro g96 pdb
-or	mindistres.xvg	Output, Opt.	xvgr/xmgr file

Other options

-h	bool	no	Print help info and quit
-version	bool	no	Print version info and quit
-nice	int	19	Set the nicelevel
-b	time	0	First frame (ps) to read from trajectory
-e	time	0	Last frame (ps) to read from trajectory
-dt	time	0	Only use frame when t MOD dt = first time (ps)
-tu	enum	ps	Time unit: fs, ps, ns, us, ms or s
-w	bool	no	View output .xvg, .xpm, .eps and .pdb files
-xvg	enum	xmgrace	xvg plot formatting: xmgrace, xmgr or none
-matrix	bool	no	Calculate half a matrix of group-group distances
-max	bool	no	Calculate *maximum* distance instead of minimum

<code>-d</code>	real	0.6	Distance for contacts
<code>-group</code>	bool	no	Count contacts with multiple atoms in the first group as one
<code>-pi</code>	bool	no	Calculate minimum distance with periodic images
<code>-split</code>	bool	no	Split graph where time is zero
<code>-ng</code>	int	1	Number of secondary groups to compute distance to a central group
<code>-pbc</code>	bool	yes	Take periodic boundary conditions into account
<code>-respertime</code>	bool	no	When writing per-residue distances, write distance for each time point
<code>-printresname</code>	bool	no	Write residue names

D.46 *g_morph*

g_morph does a linear interpolation of conformations in order to create intermediates. Of course these are completely unphysical, but that you may try to justify yourself. Output is in the form of a generic trajectory. The number of intermediates can be controlled with the `-ninterm` flag. The first and last flag correspond to the way of interpolating: 0 corresponds to input structure 1 while 1 corresponds to input structure 2. If you specify `-first < 0` or `-last > 1` extrapolation will be on the path from input structure x_1 to x_2 . In general, the coordinates of the intermediate $x(i)$ out of N total intermediates correspond to:

$$x(i) = x_1 + (i/(N-1))*(last-first)*(x_2-x_1)$$

Finally the RMSD with respect to both input structures can be computed if explicitly selected (`-or` option). In that case, an index file may be read to select the group from which the RMS is computed.

Files

<code>-f1</code>	<code>conf1.gro</code>	Input	Structure file: gro g96 pdb tpr etc.
<code>-f2</code>	<code>conf2.gro</code>	Input	Structure file: gro g96 pdb tpr etc.
<code>-o</code>	<code>interm.xtc</code>	Output	Trajectory: xtc trr trj gro g96 pdb cpt
<code>-or rms</code>	<code>interm.xvg</code>	Output, Opt.	xvgr/xmgr file
<code>-n</code>	<code>index.ndx</code>	Input, Opt.	Index file

Other options

<code>-h</code>	bool	no	Print help info and quit
<code>-version</code>	bool	no	Print version info and quit
<code>-nice</code>	int	0	Set the nicelevel
<code>-w</code>	bool	no	View output .xvg, .xpm, .eps and .pdb files
<code>-xvg</code>	enum	xmgrace	xvg plot formatting: xmgrace, xmgr or none
<code>-ninterm</code>	int	11	Number of intermediates
<code>-first</code>	real	0	Corresponds to first generated structure (0 is input x_1 , see above)
<code>-last</code>	real	1	Corresponds to last generated structure (1 is input x_2 , see above)
<code>-fit</code>	bool	yes	Do a least squares fit of the second to the first structure before interpolating

D.47 *g_msd*

g_msd computes the mean square displacement (MSD) of atoms from a set of initial positions. This provides an easy way to compute the diffusion constant using the Einstein relation. The time between the reference points for the MSD calculation is set with `-trestart`. The diffusion constant is calculated by least squares fitting a straight line ($D*t + c$) through the $MSD(t)$ from `-beginfit` to `-endfit` (note that t is time from the reference positions, not simulation time). An error estimate given, which is the difference of the diffusion coefficients obtained from fits over the two halves of the fit interval.

There are three, mutually exclusive, options to determine different types of mean square displacement: `-type`, `-lateral` and `-ten`. Option `-ten` writes the full MSD tensor for each group, the order in the output is: trace xx yy zz yx zx zy.

If `-mol` is set, `g_msd` plots the MSD for individual molecules (including making molecules whole across periodic boundaries): for each individual molecule a diffusion constant is computed for its center of mass. The chosen index group will be split into molecules.

The default way to calculate a MSD is by using mass-weighted averages. This can be turned off with `-nomw`.

With the option `-rmcomm`, the center of mass motion of a specific group can be removed. For trajectories produced with GROMACS this is usually not necessary, as `mdrun` usually already removes the center of mass motion. When you use this option be sure that the whole system is stored in the trajectory file.

The diffusion coefficient is determined by linear regression of the MSD, where, unlike for the normal output of `D`, the times are weighted according to the number of reference points, i.e. short times have a higher weight. Also when `-beginfit=-1`, fitting starts at 10% and when `-endfit=-1`, fitting goes to 90%. Using this option one also gets an accurate error estimate based on the statistics between individual molecules. Note that this diffusion coefficient and error estimate are only accurate when the MSD is completely linear between `-beginfit` and `-endfit`.

Option `-pdb` writes a `.pdb` file with the coordinates of the frame at time `-tpdb` with in the B-factor field the square root of the diffusion coefficient of the molecule. This option implies option `-mol`.

Files

<code>-f</code>	<code>traj.xtc</code>	Input	Trajectory: xtc trr trj gro g96 pdb cpt
<code>-s</code>	<code>topol.tpr</code>	Input	Structure+mass(db): tpr tpb tpa gro g96 pdb
<code>-n</code>	<code>index.ndx</code>	Input, Opt.	Index file
<code>-o</code>	<code>msd.xvg</code>	Output	xvgr/xmgr file
<code>-mol</code>	<code>diff_mol.xvg</code>	Output, Opt.	xvgr/xmgr file
<code>-pdb</code>	<code>diff_mol.pdb</code>	Output, Opt.	Protein data bank file

Other options

<code>-h</code>	bool	no	Print help info and quit
<code>-version</code>	bool	no	Print version info and quit
<code>-nice</code>	int	19	Set the nicelevel
<code>-b</code>	time	0	First frame (ps) to read from trajectory
<code>-e</code>	time	0	Last frame (ps) to read from trajectory
<code>-tu</code>	enum	ps	Time unit: fs, ps, ns, us, ms or s
<code>-w</code>	bool	no	View output <code>.xvg</code> , <code>.xpm</code> , <code>.eps</code> and <code>.pdb</code> files
<code>-xvg</code>	enum	xmgrace	xvg plot formatting: xmgrace, xmgr or none
<code>-type</code>	enum	no	Compute diffusion coefficient in one direction: no, x, y or z
<code>-lateral</code>	enum	no	Calculate the lateral diffusion in a plane perpendicular to: no, x, y or z
<code>-ten</code>	bool	no	Calculate the full tensor
<code>-ngroup</code>	int	1	Number of groups to calculate MSD for
<code>-mw</code>	bool	yes	Mass weighted MSD
<code>-rmcomm</code>	bool	no	Remove center of mass motion
<code>-tpdb</code>	time	0	The frame to use for option <code>-pdb</code> (ps)
<code>-trestart</code>	time	10	Time between restarting points in trajectory (ps)
<code>-beginfit</code>	time	-1	Start time for fitting the MSD (ps), -1 is 10%
<code>-endfit</code>	time	-1	End time for fitting the MSD (ps), -1 is 90%

D.48 gmxcheck

gmxcheck reads a trajectory (.trj, .trr or .xtc), an energy file (.ene or .edr) or an index file (.ndx) and prints out useful information about them.

Option `-c` checks for presence of coordinates, velocities and box in the file, for close contacts (smaller than `-vdwfac` and not bonded, i.e. not between `-bonlo` and `-bonhi`, all relative to the sum of both Van der Waals radii) and atoms outside the box (these may occur often and are no problem). If velocities are present, an estimated temperature will be calculated from them.

If an index file, is given its contents will be summarized.

If both a trajectory and a .tpr file are given (with `-s1`) the program will check whether the bond lengths defined in the tpr file are indeed correct in the trajectory. If not you may have non-matching files due to e.g. deshuffling or due to problems with virtual sites. With these flags, *gmxcheck* provides a quick check for such problems.

The program can compare two run input (.tpr, .tpb or .tpa) files when both `-s1` and `-s2` are supplied. Similarly a pair of trajectory files can be compared (using the `-f2` option), or a pair of energy files (using the `-e2` option).

For free energy simulations the A and B state topology from one run input file can be compared with options `-s1` and `-ab`.

In case the `-m` flag is given a LaTeX file will be written consisting of a rough outline for a methods section for a paper.

Files

<code>-f</code>	<code>traj.xtc</code>	Input, Opt.	Trajectory: xtc trr trj gro g96 pdb cpt
<code>-f2</code>	<code>traj.xtc</code>	Input, Opt.	Trajectory: xtc trr trj gro g96 pdb cpt
<code>-s1</code>	<code>top1.tpr</code>	Input, Opt.	Run input file: tpr tpb tpa
<code>-s2</code>	<code>top2.tpr</code>	Input, Opt.	Run input file: tpr tpb tpa
<code>-c</code>	<code>topol.tpr</code>	Input, Opt.	Structure+mass(db): tpr tpb tpa gro g96 pdb
<code>-e</code>	<code>ener.edr</code>	Input, Opt.	Energy file
<code>-e2</code>	<code>ener2.edr</code>	Input, Opt.	Energy file
<code>-n</code>	<code>index.ndx</code>	Input, Opt.	Index file
<code>-m</code>	<code>doc.tex</code>	Output, Opt.	LaTeX file

Other options

<code>-h</code>	bool	no	Print help info and quit
<code>-version</code>	bool	no	Print version info and quit
<code>-nice</code>	int	0	Set the nicelevel
<code>-vdwfac</code>	real	0.8	Fraction of sum of VdW radii used as warning cutoff
<code>-bonlo</code>	real	0.4	Min. fract. of sum of VdW radii for bonded atoms
<code>-bonhi</code>	real	0.7	Max. fract. of sum of VdW radii for bonded atoms
<code>-rmsd</code>	bool	no	Print RMSD for x, v and f
<code>-tol</code>	real	0.001	Relative tolerance for comparing real values defined as $2 * (a - b) / (a + b)$
<code>-abstol</code>	real	0.001	Absolute tolerance, useful when sums are close to zero.
<code>-ab</code>	bool	no	Compare the A and B topology from one file
<code>-lastener</code>	string		Last energy term to compare (if not given all are tested). It makes sense to go up until the Pressure.

D.49 gmxdump

gmxdump reads a run input file (.tpa/.tpr/.tpb), a trajectory (.trj/.trr/.xtc), an energy file

(.ene/.edr), or a checkpoint file (.cpt) and prints that to standard output in a readable format. This program is essential for checking your run input file in case of problems.

The program can also preprocess a topology to help finding problems. Note that currently setting `GMXLIB` is the only way to customize directories used for searching include files.

Files

-s	topol.tpr	Input, Opt.	Run input file: tpr tpb tpa
-f	traj.xtc	Input, Opt.	Trajectory: xtc trr trj gro g96 pdb cpt
-e	ener.edr	Input, Opt.	Energy file
-cp	state.cpt	Input, Opt.	Checkpoint file
-p	topol.top	Input, Opt.	Topology file
-mtx	hessian.mtx	Input, Opt.	Hessian matrix
-om	grompp.mdp	Output, Opt.	grompp input file with MD parameters

Other options

-h	bool	no	Print help info and quit
-version	bool	no	Print version info and quit
-nice	int	0	Set the nicelevel
-nr	bool	yes	Show index numbers in output (leaving them out makes comparison easier, but creates a useless topology)
-sys	bool	no	List the atoms and bonded interactions for the whole system instead of for each molecule type

- Position restraint output from `-sys -s` is broken

D.50 g_nmeig

`g_nmeig` calculates the eigenvectors/values of a (Hessian) matrix, which can be calculated with `mdrun`. The eigenvectors are written to a trajectory file (`-v`). The structure is written first with `t=0`. The eigenvectors are written as frames with the eigenvector number as timestamp. The eigenvectors can be analyzed with `g_anaeig`. An ensemble of structures can be generated from the eigenvectors with `g_nmens`. When mass weighting is used, the generated eigenvectors will be scaled back to plain Cartesian coordinates before generating the output. In this case, they will no longer be exactly orthogonal in the standard Cartesian norm, but in the mass-weighted norm they would be.

This program can be optionally used to compute quantum corrections to heat capacity and enthalpy by providing an extra file argument `-qcorr`. See the GROMACS manual, Chapter 1, for details. The result includes subtracting a harmonic degree of freedom at the given temperature. The total correction is printed on the terminal screen. The recommended way of getting the corrections out is:

```
g_nmeig -s topol.tpr -f nm.mtx -first 7 -last 10000 -T 300 -qc [-constr]
```

The `-constr` option should be used when bond constraints were used during the simulation **for all the covalent bonds**. If this is not the case, you need to analyze the `quant_corr.xvg` file yourself.

To make things more flexible, the program can also take virtual sites into account when computing quantum corrections. When selecting `-constr` and `-qc`, the `-begin` and `-end` options will be set automatically as well. Again, if you think you know it better, please check the `eigenfreq.xvg` output.

Files

-f	hessian.mtx	Input	Hessian matrix
-s	topol.tpr	Input	Run input file: tpr tpb tpa
-of	eigenfreq.xvg	Output	xvgr/xmgr file
-ol	eigenval.xvg	Output	xvgr/xmgr file

```

-os  spectrum.xvg  Output, Opt.  xvgr/xmgr file
-qc  quant_corr.xvg  Output, Opt.  xvgr/xmgr file
-v   eigenvec.trr  Output        Full precision trajectory: trr trj cpt

```

Other options

```

-h   bool         no  Print help info and quit
-version bool       no  Print version info and quit
-nice int         19  Set the nicelevel
-xvg enum xmgrace  xvg plot formatting: xmgrace, xmgr or none
-m   bool         yes Divide elements of Hessian by product of sqrt(mass) of involved atoms
                                prior to diagonalization. This should be used for 'Normal Modes' analysis
-first int         1  First eigenvector to write away
-last int         50  Last eigenvector to write away
-maxspec int       4000 Highest frequency (1/cm) to consider in the spectrum
-T   real        298.15 Temperature for computing quantum heat capacity and enthalpy when
                                using normal mode calculations to correct classical simulations
-constr bool       no  If constraints were used in the simulation but not in the normal mode
                                analysis (this is the recommended way of doing it) you will need to set
                                this for computing the quantum corrections.
-width real        1  Width (sigma) of the gaussian peaks (1/cm) when generating a spectrum

```

D.51 g_nmens

g_nmens generates an ensemble around an average structure in a subspace that is defined by a set of normal modes (eigenvectors). The eigenvectors are assumed to be mass-weighted. The position along each eigenvector is randomly taken from a Gaussian distribution with variance $kT/\text{eigenvalue}$.

By default the starting eigenvector is set to 7, since the first six normal modes are the translational and rotational degrees of freedom.

Files

```

-v   eigenvec.trr  Input        Full precision trajectory: trr trj cpt
-e   eigenval.xvg  Input        xvgr/xmgr file
-s   topol.tpr    Input        Structure+mass(db): tpr tpb tpa gro g96 pdb
-n   index.ndx    Input, Opt.  Index file
-o   ensemble.xtc Output       Trajectory: xtc trr trj gro g96 pdb

```

Other options

```

-h   bool         no  Print help info and quit
-version bool       no  Print version info and quit
-nice int         19  Set the nicelevel
-xvg enum xmgrace  xvg plot formatting: xmgrace, xmgr or none
-temp real        300 Temperature in Kelvin
-seed int         -1  Random seed, -1 generates a seed from time and pid
-num  int         100 Number of structures to generate
-first int         7  First eigenvector to use (-1 is select)
-last int         -1  Last eigenvector to use (-1 is till the last)

```

D.52 g_nmtraj

`g_nmtraj` generates an virtual trajectory from an eigenvector, corresponding to a harmonic Cartesian oscillation around the average structure. The eigenvectors should normally be mass-weighted, but you can use non-weighted eigenvectors to generate orthogonal motions. The output frames are written as a trajectory file covering an entire period, and the first frame is the average structure. If you write the trajectory in (or convert to) PDB format you can view it directly in PyMol and also render a photorealistic movie. Motion amplitudes are calculated from the eigenvalues and a preset temperature, assuming equipartition of the energy over all modes. To make the motion clearly visible in PyMol you might want to amplify it by setting an unrealistically high temperature. However, be aware that both the linear Cartesian displacements and mass weighting will lead to serious structure deformation for high amplitudes - this is simply a limitation of the Cartesian normal mode model. By default the selected eigenvector is set to 7, since the first six normal modes are the translational and rotational degrees of freedom.

Files

<code>-s</code>	<code>topol.tpr</code>	Input	Structure+mass(db): tpr tpb tpa gro g96 pdb
<code>-v</code>	<code>eigenvec.trr</code>	Input	Full precision trajectory: trr trj cpt
<code>-o</code>	<code>nmtraj.xtc</code>	Output	Trajectory: xtc trr trj gro g96 pdb

Other options

<code>-h</code>	bool	no	Print help info and quit
<code>-version</code>	bool	no	Print version info and quit
<code>-nice</code>	int	19	Set the nicelevel
<code>-eignr</code>	string	7	String of eigenvectors to use (first is 1)
<code>-phases</code>	string	0.0	String of phases (default is 0.0)
<code>-temp</code>	real	300	Temperature (K)
<code>-amplitude</code>	real	0.25	Amplitude for modes with eigenvalue ≤ 0
<code>-nframes</code>	int	30	Number of frames to generate

D.53 g_order

Compute the order parameter per atom for carbon tails. For atom i the vector $i-1$, $i+1$ is used together with an axis. The index file should contain only the groups to be used for calculations, with each group of equivalent carbons along the relevant acyl chain in its own group. There should not be any generic groups (like System, Protein) in the index file to avoid confusing the program (this is not relevant to tetrahedral order parameters however, which only work for water anyway).

The program can also give all diagonal elements of the order tensor and even calculate the deuterium order parameter S_{cd} (default). If the option `-szoonly` is given, only one order tensor component (specified by the `-d` option) is given and the order parameter per slice is calculated as well. If `-szoonly` is not selected, all diagonal elements and the deuterium order parameter is given.

The tetrahedrality order parameters can be determined around an atom. Both angle and distance order parameters are calculated. See P.-L. Chau and A.J. Hardwick, Mol. Phys., 93, (1998), 511-518. for more details.

Files

<code>-f</code>	<code>traj.xtc</code>	Input	Trajectory: xtc trr trj gro g96 pdb cpt
<code>-n</code>	<code>index.ndx</code>	Input	Index file
<code>-nr</code>	<code>index.ndx</code>	Input	Index file
<code>-s</code>	<code>topol.tpr</code>	Input	Run input file: tpr tpb tpa

-o	order.xvg	Output	xvgr/xmgr file
-od	deuter.xvg	Output	xvgr/xmgr file
-ob	eiwit.pdb	Output	Protein data bank file
-os	sliced.xvg	Output	xvgr/xmgr file
-Sg	sg-ang.xvg	Output, Opt.	xvgr/xmgr file
-Sk	sk-dist.xvg	Output, Opt.	xvgr/xmgr file
-Sgsl	sg-ang-slice.xvg	Output, Opt.	xvgr/xmgr file
-Sksl	sk-dist-slice.xvg	Output, Opt.	xvgr/xmgr file

Other options

-h	bool	no	Print help info and quit
-version	bool	no	Print version info and quit
-nice	int	19	Set the nicelevel
-b	time	0	First frame (ps) to read from trajectory
-e	time	0	Last frame (ps) to read from trajectory
-dt	time	0	Only use frame when t MOD dt = first time (ps)
-w	bool	no	View output .xvg, .xpm, .eps and .pdb files
-xvg	enum	xmgrace	xvg plot formatting: xmgrace, xmgr or none
-d	enum	z	Direction of the normal on the membrane: z, x or y
-sl	int	1	Calculate order parameter as function of box length, dividing the box into this number of slices.
-szonly	bool	no	Only give Sz element of order tensor. (axis can be specified with -d)
-unsat	bool	no	Calculate order parameters for unsaturated carbons. Note that this cannot be mixed with normal order parameters.
-permolecule	bool	no	Compute per-molecule S _{cd} order parameters
-radial	bool	no	Compute a radial membrane normal
-calcdist	bool	no	Compute distance from a reference

D.54 g_pme_error

g_pme_error estimates the error of the electrostatic forces if using the sPME algorithm. The flag `-tune` will determine the splitting parameter such that the error is equally distributed over the real and reciprocal space part. The part of the error that stems from self interaction of the particles is computationally demanding. However, a good approximation is to just use a fraction of the particles for this term which can be indicated by the flag `-self`.

Files

-s	topol.tpr	Input	Run input file: tpr tpb tpa
-o	error.out	Output	Generic output file
-so	tuned.tpr	Output, Opt.	Run input file: tpr tpb tpa

Other options

-h	bool	no	Print help info and quit
-version	bool	no	Print version info and quit
-nice	int	0	Set the nicelevel
-beta	real	-1	If positive, overwrite ewald_beta from .tpr file with this value
-tune	bool	no	Tune the splitting parameter such that the error is equally distributed between real and reciprocal space
-self	real	1	If between 0.0 and 1.0, determine self interaction error from just this fraction of the charged particles
-seed	int	0	Random number seed used for Monte Carlo algorithm when <code>-self</code> is set to a value between 0.0 and 1.0
-v	bool	no	Be loud and noisy

D.55 g_polystat

`g_polystat` plots static properties of polymers as a function of time and prints the average.

By default it determines the average end-to-end distance and radii of gyration of polymers. It asks for an index group and split this into molecules. The end-to-end distance is then determined using the first and the last atom in the index group for each molecules. For the radius of gyration the total and the three principal components for the average gyration tensor are written. With option `-v` the eigenvectors are written. With option `-pc` also the average eigenvalues of the individual gyration tensors are written. With option `-i` the mean square internal distances are written.

With option `-p` the persistence length is determined. The chosen index group should consist of atoms that are consecutively bonded in the polymer mainchains. The persistence length is then determined from the cosine of the angles between bonds with an index difference that is even, the odd pairs are not used, because straight polymer backbones are usually all trans and therefore only every second bond aligns. The persistence length is defined as number of bonds where the average cos reaches a value of $1/e$. This point is determined by a linear interpolation of $\log(\langle \cos \rangle)$.

Files

<code>-s</code>	<code>topol.tpr</code>	Input	Run input file: tpr tpb tpa
<code>-f</code>	<code>traj.xtc</code>	Input	Trajectory: xtc trr trj gro g96 pdb cpt
<code>-n</code>	<code>index.ndx</code>	Input, Opt.	Index file
<code>-o</code>	<code>polystat.xvg</code>	Output	xvgr/xmgr file
<code>-v</code>	<code>polyvec.xvg</code>	Output, Opt.	xvgr/xmgr file
<code>-p</code>	<code>persist.xvg</code>	Output, Opt.	xvgr/xmgr file
<code>-i</code>	<code>intdist.xvg</code>	Output, Opt.	xvgr/xmgr file

Other options

<code>-h</code>	bool	no	Print help info and quit
<code>-version</code>	bool	no	Print version info and quit
<code>-nice</code>	int	19	Set the nicelevel
<code>-b</code>	time	0	First frame (ps) to read from trajectory
<code>-e</code>	time	0	Last frame (ps) to read from trajectory
<code>-dt</code>	time	0	Only use frame when $t \text{ MOD } dt = \text{first time (ps)}$
<code>-tu</code>	enum	ps	Time unit: fs, ps, ns, us, ms or s
<code>-w</code>	bool	no	View output .xvg, .xpm, .eps and .pdb files
<code>-xvg</code>	enum	xmgrace	xvg plot formatting: xmgrace, xmgr or none
<code>-mw</code>	bool	yes	Use the mass weighting for radii of gyration
<code>-pc</code>	bool	no	Plot average eigenvalues

D.56 g_potential

`g_potential` computes the electrostatical potential across the box. The potential is calculated by first summing the charges per slice and then integrating twice of this charge distribution. Periodic boundaries are not taken into account. Reference of potential is taken to be the left side of the box. It is also possible to calculate the potential in spherical coordinates as function of r by calculating a charge distribution in spherical slices and twice integrating them. `epsilon_r` is taken as 1, but 2 is more appropriate in many cases.

Files

<code>-f</code>	<code>traj.xtc</code>	Input	Trajectory: xtc trr trj gro g96 pdb cpt
<code>-n</code>	<code>index.ndx</code>	Input	Index file
<code>-s</code>	<code>topol.tpr</code>	Input	Run input file: tpr tpb tpa

-o	potential.xvg	Output	xvgr/xmgr file
-oc	charge.xvg	Output	xvgr/xmgr file
-of	field.xvg	Output	xvgr/xmgr file

Other options

-h	bool	no	Print help info and quit
-version	bool	no	Print version info and quit
-nice	int	19	Set the nicelevel
-b	time	0	First frame (ps) to read from trajectory
-e	time	0	Last frame (ps) to read from trajectory
-dt	time	0	Only use frame when t MOD dt = first time (ps)
-w	bool	no	View output .xvg, .xpm, .eps and .pdb files
-xvg	enum	xmgrace	xvg plot formatting: xmgrace, xmgr or none
-d	string	Z	Take the normal on the membrane in direction X, Y or Z.
-sl	int	10	Calculate potential as function of boxlength, dividing the box in this number of slices.
-cb	int	0	Discard this number of first slices of box for integration
-ce	int	0	Discard this number of last slices of box for integration
-tz	real	0	Translate all coordinates by this distance in the direction of the box
-spherical	bool	no	Calculate spherical thingie
-ng	int	1	Number of groups to consider
-correct	bool	no	Assume net zero charge of groups to improve accuracy

- Discarding slices for integration should not be necessary.

D.57 g_principal

g_principal calculates the three principal axes of inertia for a group of atoms.

Files

-f	traj.xtc	Input	Trajectory: xtc trr trj gro g96 pdb cpt
-s	topol.tpr	Input	Structure+mass(db): tpr tpb tpa gro g96 pdb
-n	index.ndx	Input, Opt.	Index file
-a1	axis1.dat	Output	Generic data file
-a2	axis2.dat	Output	Generic data file
-a3	axis3.dat	Output	Generic data file
-om	moi.dat	Output	Generic data file

Other options

-h	bool	no	Print help info and quit
-version	bool	no	Print version info and quit
-nice	int	19	Set the nicelevel
-b	time	0	First frame (ps) to read from trajectory
-e	time	0	Last frame (ps) to read from trajectory
-dt	time	0	Only use frame when t MOD dt = first time (ps)
-tu	enum	ps	Time unit: fs, ps, ns, us, ms or s
-w	bool	no	View output .xvg, .xpm, .eps and .pdb files
-foo	bool	no	Dummy option to avoid empty array

D.58 g_protonate

`g_protonate` reads (a) conformation(s) and adds all missing hydrogens as defined in `gmx2.ff/aminoacids.hdb`. If only `-s` is specified, this conformation will be protonated, if also `-f` is specified, the conformation(s) will be read from this file, which can be either a single conformation or a trajectory.

If a `.pdb` file is supplied, residue names might not correspond to the GROMACS naming conventions, in which case these residues will probably not be properly protonated.

If an index file is specified, please note that the atom numbers should correspond to the **protonated** state.

Files

<code>-s</code>	<code>topol.tpr</code>	Input	Structure+mass(db): tpr tpb tpa gro g96 pdb
<code>-f</code>	<code>traj.xtc</code>	Input, Opt.	Trajectory: xtc trr trj gro g96 pdb cpt
<code>-n</code>	<code>index.ndx</code>	Input, Opt.	Index file
<code>-o</code>	<code>protonated.xtc</code>	Output	Trajectory: xtc trr trj gro g96 pdb

Other options

<code>-h</code>	bool	no	Print help info and quit
<code>-version</code>	bool	no	Print version info and quit
<code>-nice</code>	int	0	Set the nicelevel
<code>-b</code>	time	0	First frame (ps) to read from trajectory
<code>-e</code>	time	0	Last frame (ps) to read from trajectory
<code>-dt</code>	time	0	Only use frame when $t \text{ MOD } dt = \text{first time (ps)}$

- For the moment, only `.pdb` files are accepted to the `-s` flag

D.59 g_rama

`g_rama` selects the ϕ/ψ dihedral combinations from your topology file and computes these as a function of time. Using simple Unix tools such as `grep` you can select out specific residues.

Files

<code>-f</code>	<code>traj.xtc</code>	Input	Trajectory: xtc trr trj gro g96 pdb cpt
<code>-s</code>	<code>topol.tpr</code>	Input	Run input file: tpr tpb tpa
<code>-o</code>	<code>rama.xvg</code>	Output	xvgr/xmgr file

Other options

<code>-h</code>	bool	no	Print help info and quit
<code>-version</code>	bool	no	Print version info and quit
<code>-nice</code>	int	19	Set the nicelevel
<code>-b</code>	time	0	First frame (ps) to read from trajectory
<code>-e</code>	time	0	Last frame (ps) to read from trajectory
<code>-dt</code>	time	0	Only use frame when $t \text{ MOD } dt = \text{first time (ps)}$
<code>-w</code>	bool	no	View output <code>.xvg</code> , <code>.xpm</code> , <code>.eps</code> and <code>.pdb</code> files
<code>-xvg</code>	enum	xmgrace	xvg plot formatting: <code>xmgrace</code> , <code>xmgr</code> or <code>none</code>

D.60 g_rdf

The structure of liquids can be studied by either neutron or X-ray scattering. The most common way to describe liquid structure is by a radial distribution function. However, this is not easy to obtain from a scattering experiment.

g_rdf calculates radial distribution functions in different ways. The normal method is around a (set of) particle(s), the other methods are around the center of mass of a set of particles (*-com*) or to the closest particle in a set (*-surf*). With all methods, the RDF can also be calculated around axes parallel to the z-axis with option *-xy*. With option *-surf* normalization can not be used.

The option *-rdf* sets the type of RDF to be computed. Default is for atoms or particles, but one can also select center of mass or geometry of molecules or residues. In all cases, only the atoms in the index groups are taken into account. For molecules and/or the center of mass option, a run input file is required. Weighting other than COM or COG can currently only be achieved by providing a run input file with different masses. Options *-com* and *-surf* also work in conjunction with *-rdf*.

If a run input file is supplied (*-s*) and *-rdf* is set to *atom*, exclusions defined in that file are taken into account when calculating the RDF. The option *-cut* is meant as an alternative way to avoid intramolecular peaks in the RDF plot. It is however better to supply a run input file with a higher number of exclusions. For e.g. benzene a topology, setting *nrexcl* to 5 would eliminate all intramolecular contributions to the RDF. Note that all atoms in the selected groups are used, also the ones that don't have Lennard-Jones interactions.

Option *-cn* produces the cumulative number RDF, i.e. the average number of particles within a distance *r*.

To bridge the gap between theory and experiment structure factors can be computed (option *-sq*). The algorithm uses FFT, the grid spacing of which is determined by option *-grid*.

Files

<i>-f</i>	<i>traj.xtc</i>	Input	Trajectory: <i>xtc trr trj gro g96 pdb cpt</i>
<i>-s</i>	<i>topol.tpr</i>	Input, Opt.	Structure+mass(db): <i>tpr tpb tpa gro g96 pdb</i>
<i>-n</i>	<i>index.ndx</i>	Input, Opt.	Index file
<i>-d</i>	<i>sfactor.dat</i>	Input, Opt.	Generic data file
<i>-o</i>	<i>rdf.xvg</i>	Output, Opt.	<i>xvgr/xmgr</i> file
<i>-sq</i>	<i>sq.xvg</i>	Output, Opt.	<i>xvgr/xmgr</i> file
<i>-cn</i>	<i>rdf_cn.xvg</i>	Output, Opt.	<i>xvgr/xmgr</i> file
<i>-hq</i>	<i>hq.xvg</i>	Output, Opt.	<i>xvgr/xmgr</i> file

Other options

<i>-h</i>	bool	no	Print help info and quit
<i>-version</i>	bool	no	Print version info and quit
<i>-nice</i>	int	19	Set the nicelevel
<i>-b</i>	time	0	First frame (ps) to read from trajectory
<i>-e</i>	time	0	Last frame (ps) to read from trajectory
<i>-dt</i>	time	0	Only use frame when $t \text{ MOD } dt = \text{first time (ps)}$
<i>-w</i>	bool	no	View output <i>.xvg</i> , <i>.xpm</i> , <i>.eps</i> and <i>.pdb</i> files
<i>-xvg</i>	enum	<i>xmgrace</i>	xvg plot formatting: <i>xmgrace</i> , <i>xmgr</i> or <i>none</i>
<i>-bin</i>	real	0.002	Binwidth (nm)
<i>-com</i>	bool	no	RDF with respect to the center of mass of first group
<i>-surf</i>	enum	no	RDF with respect to the surface of the first group: <i>no</i> , <i>mol</i> or <i>res</i>
<i>-rdf</i>	enum	<i>atom</i>	RDF type: <i>atom</i> , <i>mol_com</i> , <i>mol_cog</i> , <i>res_com</i> or <i>res_cog</i>
<i>-pbc</i>	bool	yes	Use periodic boundary conditions for computing distances. Without PBC the maximum range will be three times the largest box edge.
<i>-norm</i>	bool	yes	Normalize for volume and density
<i>-xy</i>	bool	no	Use only the x and y components of the distance
<i>-cut</i>	real	0	Shortest distance (nm) to be considered
<i>-ng</i>	int	1	Number of secondary groups to compute RDFs around a central group
<i>-fade</i>	real	0	From this distance onwards the RDF is transformed by $g'(r) = 1 + [g(r)-1] \exp(-r/\text{fade}-1)^2$ to make it go to 1 smoothly. If <i>fade</i> is 0.0 nothing is done.
<i>-nlevel</i>	int	20	Number of different colors in the diffraction image
<i>-startq</i>	real	0	Starting <i>q</i> (1/nm)

-endq	real	60	Ending q (1/nm)
-energy	real	12	Energy of the incoming X-ray (keV)

D.61 g_rms

`g_rms` compares two structures by computing the root mean square deviation (RMSD), the size-independent ρ similarity parameter (`rho`) or the scaled ρ (`rhosc`), see Maiorov & Crippen, *Proteins* **22**, 273 (1995). This is selected by `-what`.

Each structure from a trajectory (`-f`) is compared to a reference structure. The reference structure is taken from the structure file (`-s`).

With option `-mir` also a comparison with the mirror image of the reference structure is calculated. This is useful as a reference for 'significant' values, see Maiorov & Crippen, *Proteins* **22**, 273 (1995).

Option `-prev` produces the comparison with a previous frame the specified number of frames ago.

Option `-m` produces a matrix in `.xpm` format of comparison values of each structure in the trajectory with respect to each other structure. This file can be visualized with for instance `xv` and can be converted to postscript with `xpm2ps`.

Option `-fit` controls the least-squares fitting of the structures on top of each other: complete fit (rotation and translation), translation only, or no fitting at all.

Option `-mw` controls whether mass weighting is done or not. If you select the option (default) and supply a valid `.tpr` file masses will be taken from there, otherwise the masses will be deduced from the `atommass.dat` file in `GMXLIB`. This is fine for proteins, but not necessarily for other molecules. A default mass of 12.011 amu (carbon) is assigned to unknown atoms. You can check whether this happens by turning on the `-debug` flag and inspecting the log file.

With `-f2`, the 'other structures' are taken from a second trajectory, this generates a comparison matrix of one trajectory versus the other.

Option `-bin` does a binary dump of the comparison matrix.

Option `-bm` produces a matrix of average bond angle deviations analogously to the `-m` option. Only bonds between atoms in the comparison group are considered.

Files

-s	<code>topol.tpr</code>	Input	Structure+mass(db): <code>tpr tpb tpa gro g96 pdb</code>
-f	<code>traj.xtc</code>	Input	Trajectory: <code>xtc trr trj gro g96 pdb cpt</code>
-f2	<code>traj.xtc</code>	Input, Opt.	Trajectory: <code>xtc trr trj gro g96 pdb cpt</code>
-n	<code>index.ndx</code>	Input, Opt.	Index file
-o	<code>rmsd.xvg</code>	Output	<code>xvgr/xmgr</code> file
-mir	<code>rmsdmir.xvg</code>	Output, Opt.	<code>xvgr/xmgr</code> file
-a	<code>avgrp.xvg</code>	Output, Opt.	<code>xvgr/xmgr</code> file
-dist	<code>rmsd-dist.xvg</code>	Output, Opt.	<code>xvgr/xmgr</code> file
-m	<code>rmsd.xpm</code>	Output, Opt.	X Pixmap compatible matrix file
-bin	<code>rmsd.dat</code>	Output, Opt.	Generic data file
-bm	<code>bond.xpm</code>	Output, Opt.	X Pixmap compatible matrix file

Other options

-h	bool	no	Print help info and quit
-version	bool	no	Print version info and quit
-nice	int	19	Set the nicelevel
-b	time	0	First frame (ps) to read from trajectory
-e	time	0	Last frame (ps) to read from trajectory

-dt	time	0	Only use frame when t MOD dt = first time (ps)
-tu	enum	ps	Time unit: fs, ps, ns, us, ms or s
-w	bool	no	View output .xvg, .xpm, .eps and .pdb files
-xvg	enum	xmgrace	xvg plot formatting: xmgrace, xmgr or none
-what	enum	rmsd	Structural difference measure: rmsd, rho or rhosc
-pbc	bool	yes	PBC check
-fit	enum	rot+trans	Fit to reference structure: rot+trans, translation or none
-prev	int	0	Compare with previous frame
-split	bool	no	Split graph where time is zero
-skip	int	1	Only write every nr-th frame to matrix
-skip2	int	1	Only write every nr-th frame to matrix
-max	real	-1	Maximum level in comparison matrix
-min	real	-1	Minimum level in comparison matrix
-bmax	real	-1	Maximum level in bond angle matrix
-bmin	real	-1	Minimum level in bond angle matrix
-mw	bool	yes	Use mass weighting for superposition
-nlevels	int	80	Number of levels in the matrices
-ng	int	1	Number of groups to compute RMS between

D.62 *g_rmsdist*

g_rmsdist computes the root mean square deviation of atom distances, which has the advantage that no fit is needed like in standard RMS deviation as computed by *g_rms*. The reference structure is taken from the structure file. The RMSD at time t is calculated as the RMS of the differences in distance between atom-pairs in the reference structure and the structure at time t.

g_rmsdist can also produce matrices of the rms distances, rms distances scaled with the mean distance and the mean distances and matrices with NMR averaged distances ($1/r^3$ and $1/r^6$ averaging). Finally, lists of atom pairs with $1/r^3$ and $1/r^6$ averaged distance below the maximum distance (*-max*, which will default to 0.6 in this case) can be generated, by default averaging over equivalent hydrogens (all triplets of hydrogens named *[123]). Additionally a list of equivalent atoms can be supplied (*-equiv*), each line containing a set of equivalent atoms specified as residue number and name and atom name; e.g.:

```
3 SER HB1 3 SER HB2
```

Residue and atom names must exactly match those in the structure file, including case. Specifying non-sequential atoms is undefined.

Files

-f	traj.xtc	Input	Trajectory: xtc trr trj gro g96 pdb cpt
-s	topol.tpr	Input	Structure+mass(db): tpr tpb tpa gro g96 pdb
-n	index.ndx	Input, Opt.	Index file
-equiv	equiv.dat	Input, Opt.	Generic data file
-o	distrmsd.xvg	Output	xvgr/xmgr file
-rms	rmsdist.xpm	Output, Opt.	X PixMap compatible matrix file
-scl	rms scale.xpm	Output, Opt.	X PixMap compatible matrix file
-mean	rmsmean.xpm	Output, Opt.	X PixMap compatible matrix file
-nmr3	nmr3.xpm	Output, Opt.	X PixMap compatible matrix file
-nmr6	nmr6.xpm	Output, Opt.	X PixMap compatible matrix file
-noe	noe.dat	Output, Opt.	Generic data file

Other options

-h	bool	no	Print help info and quit
-version	bool	no	Print version info and quit
-nice	int	19	Set the nicelevel
-b	time	0	First frame (ps) to read from trajectory
-e	time	0	Last frame (ps) to read from trajectory
-dt	time	0	Only use frame when t MOD dt = first time (ps)
-w	bool	no	View output .xvg, .xpm, .eps and .pdb files
-xvg	enum	xmgrace	xvg plot formatting: xmgrace, xmgr or none
-nlevels	int	40	Discretize RMS in this number of levels
-max	real	-1	Maximum level in matrices
-sumh	bool	yes	Average distance over equivalent hydrogens
-pbc	bool	yes	Use periodic boundary conditions when computing distances

D.63 g_rmsf

`g_rmsf` computes the root mean square fluctuation (RMSF, i.e. standard deviation) of atomic positions in the trajectory (supplied with `-f`) after (optionally) fitting to a reference frame (supplied with `-s`).

With option `-oq` the RMSF values are converted to B-factor values, which are written to a `.pdb` file with the coordinates, of the structure file, or of a `.pdb` file when `-q` is specified. Option `-ox` writes the B-factors to a file with the average coordinates.

With the option `-od` the root mean square deviation with respect to the reference structure is calculated.

With the option `-aniso`, `g_rmsf` will compute anisotropic temperature factors and then it will also output average coordinates and a `.pdb` file with ANISOU records (corresponding to the `-oq` or `-ox` option). Please note that the U values are orientation-dependent, so before comparison with experimental data you should verify that you fit to the experimental coordinates.

When a `.pdb` input file is passed to the program and the `-aniso` flag is set a correlation plot of the U_{ij} will be created, if any anisotropic temperature factors are present in the `.pdb` file.

With option `-dir` the average MSF (3x3) matrix is diagonalized. This shows the directions in which the atoms fluctuate the most and the least.

Files

-f	traj.xtc	Input	Trajectory: xtc trr trj gro g96 pdb cpt
-s	topol.tpr	Input	Structure+mass(db): tpr tpb tpa gro g96 pdb
-n	index.ndx	Input, Opt.	Index file
-q	eiwit.pdb	Input, Opt.	Protein data bank file
-oq	bfac.pdb	Output, Opt.	Protein data bank file
-ox	xaver.pdb	Output, Opt.	Protein data bank file
-o	rmsf.xvg	Output	xvgr/xmgr file
-od	rmsdev.xvg	Output, Opt.	xvgr/xmgr file
-oc	correl.xvg	Output, Opt.	xvgr/xmgr file
-dir	rmsf.log	Output, Opt.	Log file

Other options

-h	bool	no	Print help info and quit
-version	bool	no	Print version info and quit
-nice	int	19	Set the nicelevel
-b	time	0	First frame (ps) to read from trajectory
-e	time	0	Last frame (ps) to read from trajectory

-dt	time	0	Only use frame when t MOD dt = first time (ps)
-w	bool	no	View output .xvg, .xpm, .eps and .pdb files
-xvg	enum	xmgrace	xvg plot formatting: xmgrace, xmgr or none
-res	bool	no	Calculate averages for each residue
-aniso	bool	no	Compute anisotropic temperature factors
-fit	bool	yes	Do a least squares superposition before computing RMSF. Without this you must make sure that the reference structure and the trajectory match.

D.64 grompp

The gromacs preprocessor reads a molecular topology file, checks the validity of the file, expands the topology from a molecular description to an atomic description. The topology file contains information about molecule types and the number of molecules, the preprocessor copies each molecule as needed. There is no limitation on the number of molecule types. Bonds and bond-angles can be converted into constraints, separately for hydrogens and heavy atoms. Then a coordinate file is read and velocities can be generated from a Maxwellian distribution if requested. `grompp` also reads parameters for the `mdrun` (eg. number of MD steps, time step, cut-off), and others such as NEMD parameters, which are corrected so that the net acceleration is zero. Eventually a binary file is produced that can serve as the sole input file for the MD program.

`grompp` uses the atom names from the topology file. The atom names in the coordinate file (option `-c`) are only read to generate warnings when they do not match the atom names in the topology. Note that the atom names are irrelevant for the simulation as only the atom types are used for generating interaction parameters.

`grompp` uses a built-in preprocessor to resolve includes, macros, etc. The preprocessor supports the following keywords:

```
#ifdef VARIABLE
#endif
#define VARIABLE
#undef VARIABLE
#include "filename"
#include <filename>
```

The functioning of these statements in your topology may be modulated by using the following two flags in your `.mdp` file:

```
define = -DVARIABLE1 -DVARIABLE2
include = -I/home/john/doe
```

For further information a C-programming textbook may help you out. Specifying the `-pp` flag will get the pre-processed topology file written out so that you can verify its contents.

When using position restraints a file with restraint coordinates can be supplied with `-r`, otherwise restraining will be done with respect to the conformation from the `-c` option. For free energy calculation the the coordinates for the B topology can be supplied with `-rb`, otherwise they will be equal to those of the A topology.

Starting coordinates can be read from trajectory with `-t`. The last frame with coordinates and velocities will be read, unless the `-time` option is used. Only if this information is absent will the coordinates in the `-c` file be used. Note that these velocities will not be used when `gen_vel = yes` in your `.mdp` file. An energy file can be supplied with `-e` to read Nose-Hoover and/or Parrinello-Rahman coupling variables.

`grompp` can be used to restart simulations (preserving continuity) by supplying just a checkpoint file with `-t`. However, for simply changing the number of run steps to extend a run, using `tpbconv` is more convenient than `grompp`. You then supply the old checkpoint file directly to `mdrun` with `-cpi`. If you wish to change the ensemble or things like output frequency, then supplying the checkpoint file to `grompp` with `-t` along with a new `.mdp` file with `-f` is the recommended procedure.

By default, all bonded interactions which have constant energy due to virtual site constructions will be removed. If this constant energy is not zero, this will result in a shift in the total energy. All bonded interactions can be kept by turning off `-rmvsbds`. Additionally, all constraints for distances which will be constant anyway because of virtual site constructions will be removed. If any constraints remain which involve virtual sites, a fatal error will result.

To verify your run input file, please take note of all warnings on the screen, and correct where necessary. Do also look at the contents of the `mdout.mdp` file; this contains comment lines, as well as the input that `grompp` has read. If in doubt, you can start `grompp` with the `-debug` option which will give you more information in a file called `grompp.log` (along with real debug info). You can see the contents of the run input file with the `gmxdump` program. `gmxccheck` can be used to compare the contents of two run input files.

The `-maxwarn` option can be used to override warnings printed by `grompp` that otherwise halt output. In some cases, warnings are harmless, but usually they are not. The user is advised to carefully interpret the output messages before attempting to bypass them with this option.

Files

<code>-f</code>	<code>grompp.mdp</code>	Input	<code>grompp</code> input file with MD parameters
<code>-po</code>	<code>mdout.mdp</code>	Output	<code>grompp</code> input file with MD parameters
<code>-c</code>	<code>conf.gro</code>	Input	Structure file: <code>gro g96 pdb tpr</code> etc.
<code>-r</code>	<code>conf.gro</code>	Input, Opt.	Structure file: <code>gro g96 pdb tpr</code> etc.
<code>-rb</code>	<code>conf.gro</code>	Input, Opt.	Structure file: <code>gro g96 pdb tpr</code> etc.
<code>-n</code>	<code>index.ndx</code>	Input, Opt.	Index file
<code>-p</code>	<code>topol.top</code>	Input	Topology file
<code>-pp</code>	<code>processed.top</code>	Output, Opt.	Topology file
<code>-o</code>	<code>topol.tpr</code>	Output	Run input file: <code>tpr tpb tpa</code>
<code>-t</code>	<code>traj.trr</code>	Input, Opt.	Full precision trajectory: <code>trr trj cpt</code>
<code>-e</code>	<code>ener.edr</code>	Input, Opt.	Energy file
<code>-ref</code>	<code>rotref.trr</code>	In/Out, Opt.	Full precision trajectory: <code>trr trj cpt</code>

Other options

<code>-h</code>	bool	no	Print help info and quit
<code>-version</code>	bool	no	Print version info and quit
<code>-nice</code>	int	0	Set the nicelevel
<code>-v</code>	bool	no	Be loud and noisy
<code>-time</code>	real	-1	Take frame at or first after this time.
<code>-rmvsbds</code>	bool	yes	Remove constant bonded interactions with virtual sites
<code>-maxwarn</code>	int	0	Number of allowed warnings during input processing. Not for normal use and may generate unstable systems
<code>-zero</code>	bool	no	Set parameters for bonded interactions without defaults to zero instead of generating an error
<code>-renum</code>	bool	yes	Renumber atomtypes and minimize number of atomtypes

D.65 `g_rotacf`

`g_rotacf` calculates the rotational correlation function for molecules. Atom triplets (i,j,k) must be given in the index file, defining two vectors ij and jk. The rotational ACF is calculated as the autocorrelation

function of the vector $n = ij \times jk$, i.e. the cross product of the two vectors. Since three atoms span a plane, the order of the three atoms does not matter. Optionally, by invoking the `-d` switch, you can calculate the rotational correlation function for linear molecules by specifying atom pairs (i,j) in the index file.

EXAMPLES

```
g_rotacf -P 1 -nparm 2 -fft -n index -o rotacf-x-P1 -fa expfit-x-P1 -beginfit
2.5 -endfit 20.0
```

This will calculate the rotational correlation function using a first order Legendre polynomial of the angle of a vector defined by the index file. The correlation function will be fitted from 2.5 ps until 20.0 ps to a two-parameter exponential.

Files

<code>-f</code>	<code>traj.xtc</code>	Input	Trajectory: xtc trr trj gro g96 pdb cpt
<code>-s</code>	<code>topol.tpr</code>	Input	Run input file: tpr tpb tpa
<code>-n</code>	<code>index.ndx</code>	Input	Index file
<code>-o</code>	<code>rotacf.xvg</code>	Output	xvgr/xmgr file

Other options

<code>-h</code>	bool	no	Print help info and quit
<code>-version</code>	bool	no	Print version info and quit
<code>-nice</code>	int	19	Set the nicelevel
<code>-b</code>	time	0	First frame (ps) to read from trajectory
<code>-e</code>	time	0	Last frame (ps) to read from trajectory
<code>-dt</code>	time	0	Only use frame when $t \text{ MOD } dt = \text{first time (ps)}$
<code>-w</code>	bool	no	View output <code>.xvg</code> , <code>.xpm</code> , <code>.eps</code> and <code>.pdb</code> files
<code>-xvg</code>	enum	xmgrace	xvg plot formatting: xmgrace, xmgr or none
<code>-d</code>	bool	no	Use index doublets (vectors) for correlation function instead of triplets (planes)
<code>-aver</code>	bool	yes	Average over molecules
<code>-acflen</code>	int	-1	Length of the ACF, default is half the number of frames
<code>-normalize</code>	bool	yes	Normalize ACF
<code>-P</code>	enum	0	Order of Legendre polynomial for ACF (0 indicates none): 0, 1, 2 or 3
<code>-fitfn</code>	enum	none	Fit function: none, exp, aexp, exp_exp, vac, exp5, exp7, exp9 or erffit
<code>-ncskip</code>	int	0	Skip this many points in the output file of correlation functions
<code>-beginfit</code>	real	0	Time where to begin the exponential fit of the correlation function
<code>-endfit</code>	real	-1	Time where to end the exponential fit of the correlation function, -1 is until the end

D.66 *g_rotmat*

`g_rotmat` plots the rotation matrix required for least squares fitting a conformation onto the reference conformation provided with `-s`. Translation is removed before fitting. The output are the three vectors that give the new directions of the x, y and z directions of the reference conformation, for example: (zx,zy,zz) is the orientation of the reference z-axis in the trajectory frame.

This tool is useful for, for instance, determining the orientation of a molecule at an interface, possibly on a trajectory produced with `trjconv -fit rotxy+transxy` to remove the rotation in the x-y plane.

Option `-ref` determines a reference structure for fitting, instead of using the structure from `-s`. The structure with the lowest sum of RMSD's to all other structures is used. Since the computational cost of this procedure grows with the square of the number of frames, the `-skip` option can be useful. A full fit or only a fit in the x-y plane can be performed.

Option `-fitxy` fits in the x-y plane before determining the rotation matrix.

Files

-f	traj.xtc	Input	Trajectory: xtc trr trj gro g96 pdb cpt
-s	topol.tpr	Input	Structure+mass(db): tpr tpb tpa gro g96 pdb
-n	index.ndx	Input, Opt.	Index file
-o	rotmat.xvg	Output	xvgr/xmgr file

Other options

-h	bool	no	Print help info and quit
-version	bool	no	Print version info and quit
-nice	int	19	Set the nicelevel
-b	time	0	First frame (ps) to read from trajectory
-e	time	0	Last frame (ps) to read from trajectory
-dt	time	0	Only use frame when t MOD dt = first time (ps)
-w	bool	no	View output .xvg, .xpm, .eps and .pdb files
-xvg	enum	xmgrace	xvg plot formatting: xmgrace, xmgr or none
-ref	enum	none	Determine the optimal reference structure: none, xyz or xy
-skip	int	1	Use every nr-th frame for -ref
-fitxy	bool	no	Fit the x/y rotation before determining the rotation
-mw	bool	yes	Use mass weighted fitting

D.67 g_saltbr

`g_saltbr` plots the distance between all combination of charged groups as a function of time. The groups are combined in different ways. A minimum distance can be given (i.e. a cut-off), such that groups that are never closer than that distance will not be plotted.

Output will be in a number of fixed filenames, `min-min.xvg`, `plus-min.xvg` and `plus-plus.xvg`, or files for every individual ion pair if the `-sep` option is selected. In this case, files are named as `sb-(Resname) (Resnr) - (Atomnr)`. There may be **many** such files.

Files

-f	traj.xtc	Input	Trajectory: xtc trr trj gro g96 pdb cpt
-s	topol.tpr	Input	Run input file: tpr tpb tpa

Other options

-h	bool	no	Print help info and quit
-version	bool	no	Print version info and quit
-nice	int	19	Set the nicelevel
-b	time	0	First frame (ps) to read from trajectory
-e	time	0	Last frame (ps) to read from trajectory
-dt	time	0	Only use frame when t MOD dt = first time (ps)
-t	real	1000	Groups that are never closer than this distance are not plotted
-sep	bool	no	Use separate files for each interaction (may be MANY)

D.68 g_sans

This is simple tool to compute SANS spectra using Debye formula It currently uses topology file (since it need to assigne element for each atom)

Parameters:

- pr Computes normalized $g(r)$ function averaged over trajectory
- prframe Computes normalized $g(r)$ function for each frame
- sq Computes SANS intensity curve averaged over trajectory
- sqframe Computes SANS intensity curve for each frame
- startq Starting q value in nm
- endq Ending q value in nm
- qstep Stepping in q space

Note: When using Debye direct method computational cost increases as $1/2 * N * (N - 1)$ where N is atom number in group of interest

WARNING: If sq or pr specified this tool can produce large number of files! Up to two times larger than number of frames!

Files

-s	topol.tpr	Input	Run input file: tpr tpb tpa
-f	traj.xtc	Input	Trajectory: xtc trr trj gro g96 pdb cpt
-n	index.ndx	Input, Opt.	Index file
-d	nsfactor.dat	Input, Opt.	Generic data file
-pr	pr.xvg	Output	xvgr/xmgr file
-sq	sq.xvg	Output	xvgr/xmgr file
-prframe	prframe.xvg	Output, Opt.	xvgr/xmgr file
-sqframe	sqframe.xvg	Output, Opt.	xvgr/xmgr file

Other options

-h	bool	no	Print help info and quit
-version	bool	no	Print version info and quit
-nice	int	19	Set the nicelevel
-b	time	0	First frame (ps) to read from trajectory
-e	time	0	Last frame (ps) to read from trajectory
-dt	time	0	Only use frame when $t \text{ MOD } dt = \text{first time (ps)}$
-tu	enum	ps	Time unit: fs, ps, ns, us, ms or s
-xvg	enum	xmgrace	xvg plot formatting: xmgrace, xmgr or none
-mode	enum	direct	Mode for sans spectra calculation: direct or mc
-mcover	real	-1	Monte-Carlo coverage should be -1(default) or (0,1]
-pbc	bool	yes	Use periodic boundary conditions for computing distances
-startq	real	0	Starting q (1/nm)
-endq	real	2	Ending q (1/nm)
-qstep	real	0.01	Stepping in q (1/nm)
-seed	int	0	Random seed for Monte-Carlo

D.69 *g_sas*

g_sas computes hydrophobic, hydrophilic and total solvent accessible surface area. See Eisenhaber F, Lijnzaad P, Argos P, Sander C, & Scharf M (1995) J. Comput. Chem. 16, 273-284. As a side effect, the Connolly surface can be generated as well in a .pdb file where the nodes are represented as atoms and the vertice connecting the nearest nodes as CONECT records. The program will ask for a group for the surface calculation and a group for the output. The calculation group should always consists of all the non-solvent atoms in the system. The output group can be the whole or part of the calculation group. The average and standard deviation of the area over the trajectory can be plotted per residue and atom as well (options -or

and `-oa`). In combination with the latter option an `.itp` file can be generated (option `-i`) which can be used to restrain surface atoms.

By default, periodic boundary conditions are taken into account, this can be turned off using the `-nopbc` option.

With the `-tv` option the total volume and density of the molecule can be computed. Please consider whether the normal probe radius is appropriate in this case or whether you would rather use e.g. 0. It is good to keep in mind that the results for volume and density are very approximate. For example, in ice Ih, one can easily fit water molecules in the pores which would yield a volume that is too low, and surface area and density that are both too high.

Files

<code>-f</code>	<code>traj.xtc</code>	Input	Trajectory: xtc trr trj gro g96 pdb cpt
<code>-s</code>	<code>topol.tpr</code>	Input	Structure+mass(db): tpr tpb tpa gro g96 pdb
<code>-o</code>	<code>area.xvg</code>	Output	xvgr/xmgr file
<code>-or</code>	<code>resarea.xvg</code>	Output, Opt.	xvgr/xmgr file
<code>-oa</code>	<code>atomarea.xvg</code>	Output, Opt.	xvgr/xmgr file
<code>-tv</code>	<code>volume.xvg</code>	Output, Opt.	xvgr/xmgr file
<code>-q</code>	<code>connelly.pdb</code>	Output, Opt.	Protein data bank file
<code>-n</code>	<code>index.ndx</code>	Input, Opt.	Index file
<code>-i</code>	<code>surfat.itp</code>	Output, Opt.	Include file for topology

Other options

<code>-h</code>	bool	no	Print help info and quit
<code>-version</code>	bool	no	Print version info and quit
<code>-nice</code>	int	19	Set the nicelevel
<code>-b</code>	time	0	First frame (ps) to read from trajectory
<code>-e</code>	time	0	Last frame (ps) to read from trajectory
<code>-dt</code>	time	0	Only use frame when $t \text{ MOD } dt = \text{first time (ps)}$
<code>-w</code>	bool	no	View output <code>.xvg</code> , <code>.xpm</code> , <code>.eps</code> and <code>.pdb</code> files
<code>-xvg</code>	enum	xmgrace	xvg plot formatting: <code>xmgrace</code> , <code>xmgr</code> or <code>none</code>
<code>-probe</code>	real	0.14	Radius of the solvent probe (nm)
<code>-ndots</code>	int	24	Number of dots per sphere, more dots means more accuracy
<code>-qmax</code>	real	0.2	The maximum charge (e, absolute value) of a hydrophobic atom
<code>-f_index</code>	bool	no	Determine from a group in the index file what are the hydrophobic atoms rather than from the charge
<code>-minarea</code>	real	0.5	The minimum area (nm ²) to count an atom as a surface atom when writing a position restraint file (see help)
<code>-pbc</code>	bool	yes	Take periodicity into account
<code>-prot</code>	bool	yes	Output the protein to the Connelly <code>.pdb</code> file too
<code>-dgs</code>	real	0	Default value for solvation free energy per area (kJ/mol/nm ²)

D.70 g_select

`g_select` writes out basic data about dynamic selections. It can be used for some simple analyses, or the output can be combined with output from other programs and/or external analysis programs to calculate more complex things. Any combination of the output options is possible, but note that `-om` only operates on the first selection. `-os` is the default output option if none is selected.

With `-os`, calculates the number of positions in each selection for each frame. With `-norm`, the output is between 0 and 1 and describes the fraction from the maximum number of positions (e.g., for selection 'resname RA and x < 5' the maximum number of positions is the number of atoms in RA residues). With

`-cfnorm`, the output is divided by the fraction covered by the selection. `-norm` and `-cfnorm` can be specified independently of one another.

With `-oc`, the fraction covered by each selection is written out as a function of time.

With `-oi`, the selected atoms/residues/molecules are written out as a function of time. In the output, the first column contains the frame time, the second contains the number of positions, followed by the atom/residue/molecule numbers. If more than one selection is specified, the size of the second group immediately follows the last number of the first group and so on. With `-dump`, the frame time and the number of positions is omitted from the output. In this case, only one selection can be given.

With `-on`, the selected atoms are written as an index file compatible with `make_ndx` and the analyzing tools. Each selection is written as a selection group and for dynamic selections a group is written for each frame.

For residue numbers, the output of `-oi` can be controlled with `-resnr: number` (default) prints the residue numbers as they appear in the input file, while `index` prints unique numbers assigned to the residues in the order they appear in the input file, starting with 1. The former is more intuitive, but if the input contains multiple residues with the same number, the output can be less useful.

With `-om`, a mask is printed for the first selection as a function of time. Each line in the output corresponds to one frame, and contains either 0/1 for each atom/residue/molecule possibly selected. 1 stands for the atom/residue/molecule being selected for the current frame, 0 for not selected. With `-dump`, the frame time is omitted from the output.

Files

<code>-f</code>	<code>traj.xtc</code>	Input, Opt.	Trajectory: xtc trr trj gro g96 pdb cpt
<code>-s</code>	<code>topol.tpr</code>	Input, Opt.	Structure+mass(db): tpr tpb tpa gro g96 pdb
<code>-sf</code>	<code>selection.dat</code>	Input, Opt.	Generic data file
<code>-n</code>	<code>index.ndx</code>	Input, Opt.	Index file
<code>-os</code>	<code>size.xvg</code>	Output, Opt.	xvgr/xmgr file
<code>-oc</code>	<code>cfrac.xvg</code>	Output, Opt.	xvgr/xmgr file
<code>-oi</code>	<code>index.dat</code>	Output, Opt.	Generic data file
<code>-om</code>	<code>mask.dat</code>	Output, Opt.	Generic data file
<code>-on</code>	<code>index.ndx</code>	Output, Opt.	Index file

Other options

<code>-h</code>	bool	no	Print help info and quit
<code>-version</code>	bool	no	Print version info and quit
<code>-nice</code>	int	19	Set the nicelevel
<code>-b</code>	time	0	First frame (ps) to read from trajectory
<code>-e</code>	time	0	Last frame (ps) to read from trajectory
<code>-dt</code>	time	0	Only use frame when $t \text{ MOD } dt = \text{first time (ps)}$
<code>-xvg</code>	enum	xmgrace	xvg plot formatting: xmgrace, xmgr or none
<code>-rmpbc</code>	bool	yes	Make molecules whole for each frame
<code>-pbc</code>	bool	yes	Use periodic boundary conditions for distance calculation
<code>-select</code>	string		Selection string (use 'help' for help). Note that the whole selection string will need to be quoted so that your shell will pass it in as a string. Example: <code>g_select -select ' "Nearby water" resname SOL and within 0.25 of group Protein'</code>
<code>-selrpos</code>	enum	atom	Selection reference position: atom, res_com, res_cog, mol_com, mol_cog, whole_res_com, whole_res_cog, whole_mol_com, whole_mol_cog, part_res_com, part_res_cog, part_mol_com, part_mol_cog, dyn_res_com, dyn_res_cog, dyn_mol_com or dyn_mol_cog

```

-seltype enum    atom  Default analysis positions: atom, res_com, res_cog, mol_
                    com, mol_cog, whole_res_com, whole_res_cog, whole_
                    mol_com, whole_mol_cog, part_res_com, part_res_cog,
                    part_mol_com, part_mol_cog, dyn_res_com, dyn_res_
                    cog, dyn_mol_com or dyn_mol_cog
  -dump  bool     no    Do not print the frame time (-om, -oi) or the index size (-oi)
  -norm  bool     no    Normalize by total number of positions with -os
  -cfnorm bool     no    Normalize by covered fraction with -os
  -resnr enum    number Residue number output type: number or index

```

D.71 g_sgangle

Compute the angle and distance between two groups. The groups are defined by a number of atoms given in an index file and may be two or three atoms in size. If `-one` is set, only one group should be specified in the index file and the angle between this group at time 0 and t will be computed. The angles calculated depend on the order in which the atoms are given. Giving, for instance, 5 6 will rotate the vector 5-6 with 180 degrees compared to giving 6 5.

If three atoms are given, the normal on the plane spanned by those three atoms will be calculated, using the formula $P1P2 \times P1P3$. The cos of the angle is calculated, using the inproduct of the two normalized vectors.

Here is what some of the file options do:

`-oa`: Angle between the two groups specified in the index file. If a group contains three atoms the normal to the plane defined by those three atoms will be used. If a group contains two atoms, the vector defined by those two atoms will be used.

`-od`: Distance between two groups. Distance is taken from the center of one group to the center of the other group.

`-od1`: If one plane and one vector is given, the distances for each of the atoms from the center of the plane is given separately.

`-od2`: For two planes this option has no meaning.

Files

```

-f      traj.xtc  Input      Trajectory: xtc trr trj gro g96 pdb cpt
-n      index.ndx Input      Index file
-s      topol.tpr Input      Run input file: tpr tpb tpa
-oa     sg_angle.xvg Output     xvgr/xmgr file
-od     sg_dist.xvg Output, Opt. xvgr/xmgr file
-od1    sg_dist1.xvg Output, Opt. xvgr/xmgr file
-od2    sg_dist2.xvg Output, Opt. xvgr/xmgr file

```

Other options

```

-h  bool    no    Print help info and quit
-version bool  no    Print version info and quit
-nice int    19   Set the nicelevel
-b  time    0    First frame (ps) to read from trajectory
-e  time    0    Last frame (ps) to read from trajectory
-dt time    0    Only use frame when t MOD dt = first time (ps)
-w  bool    no    View output .xvg, .xpm, .eps and .pdb files
-xvg enum xmgrace xvgr plot formatting: xmgrace, xmgr or none
-one bool    no    Only one group compute angle between vector at time zero and time t
-z  bool    no    Use the z-axis as reference

```

D.72 *g_sham*

g_sham makes multi-dimensional free-energy, enthalpy and entropy plots. *g_sham* reads one or more *.xvg* files and analyzes data sets. The basic purpose of *g_sham* is to plot Gibbs free energy landscapes (option *-ls*) by Boltzmann inverting multi-dimensional histograms (option *-lp*), but it can also make enthalpy (option *-lsh*) and entropy (option *-lss*) plots. The histograms can be made for any quantities the user supplies. A line in the input file may start with a time (see option *-time*) and any number of *y*-values may follow. Multiple sets can also be read when they are separated by *&* (option *-n*), in this case only one *y*-value is read from each line. All lines starting with *#* and *@* are skipped.

Option *-ge* can be used to supply a file with free energies when the ensemble is not a Boltzmann ensemble, but needs to be biased by this free energy. One free energy value is required for each (multi-dimensional) data point in the *-f* input.

Option *-ene* can be used to supply a file with energies. These energies are used as a weighting function in the single histogram analysis method by Kumar et al. When temperatures are supplied (as a second column in the file), an experimental weighting scheme is applied. In addition the values are used for making enthalpy and entropy plots.

With option *-dim*, dimensions can be given for distances. When a distance is 2- or 3-dimensional, the circumference or surface sampled by two particles increases with increasing distance. Depending on what one would like to show, one can choose to correct the histogram and free-energy for this volume effect. The probability is normalized by *r* and *r*² for dimensions of 2 and 3, respectively. A value of -1 is used to indicate an angle in degrees between two vectors: a *sin*(angle) normalization will be applied. **Note** that for angles between vectors the inner-product or cosine is the natural quantity to use, as it will produce bins of the same volume.

Files

<i>-f</i>	<i>graph.xvg</i>	Input	<i>xvgr/xmgr</i> file
<i>-ge</i>	<i>gibbs.xvg</i>	Input, Opt.	<i>xvgr/xmgr</i> file
<i>-ene</i>	<i>esham.xvg</i>	Input, Opt.	<i>xvgr/xmgr</i> file
<i>-dist</i>	<i>ener.xvg</i>	Output, Opt.	<i>xvgr/xmgr</i> file
<i>-histo</i>	<i>edist.xvg</i>	Output, Opt.	<i>xvgr/xmgr</i> file
<i>-bin</i>	<i>bindex.ndx</i>	Output, Opt.	Index file
<i>-lp</i>	<i>prob.xpm</i>	Output, Opt.	X PixMap compatible matrix file
<i>-ls</i>	<i>gibbs.xpm</i>	Output, Opt.	X PixMap compatible matrix file
<i>-lsh</i>	<i>enthalpy.xpm</i>	Output, Opt.	X PixMap compatible matrix file
<i>-lss</i>	<i>entropy.xpm</i>	Output, Opt.	X PixMap compatible matrix file
<i>-map</i>	<i>map.xpm</i>	Output, Opt.	X PixMap compatible matrix file
<i>-ls3</i>	<i>gibbs3.pdb</i>	Output, Opt.	Protein data bank file
<i>-mdata</i>	<i>mapdata.xvg</i>	Input, Opt.	<i>xvgr/xmgr</i> file
<i>-g</i>	<i>shamlog.log</i>	Output, Opt.	Log file

Other options

<i>-h</i>	bool	no	Print help info and quit
<i>-version</i>	bool	no	Print version info and quit
<i>-nice</i>	int	19	Set the nicelevel
<i>-w</i>	bool	no	View output <i>.xvg</i> , <i>.xpm</i> , <i>.eps</i> and <i>.pdb</i> files
<i>-xvg</i>	enum	<i>xmgrace</i>	xvg plot formatting: <i>xmgrace</i> , <i>xmgr</i> or <i>none</i>
<i>-time</i>	bool	yes	Expect a time in the input
<i>-b</i>	real	-1	First time to read from set
<i>-e</i>	real	-1	Last time to read from set
<i>-ttol</i>	real	0	Tolerance on time in appropriate units (usually ps)
<i>-n</i>	int	1	Read this number of sets separated by lines containing only an ampersand
<i>-d</i>	bool	no	Use the derivative

-bw	real	0.1	Binwidth for the distribution
-sham	bool	yes	Turn off energy weighting even if energies are given
-tsham	real	298.15	Temperature for single histogram analysis
-pmin	real	0	Minimum probability. Anything lower than this will be set to zero
-dim	vector	1 1 1	Dimensions for distances, used for volume correction (max 3 values, dimensions > 3 will get the same value as the last)
-ngrid	vector	32 32	Number of bins for energy landscapes (max 3 values, dimensions > 3 will get the same value as the last)
-xmin	vector	0 0 0	Minimum for the axes in energy landscape (see above for > 3 dimensions)
-xmax	vector	1 1 1	Maximum for the axes in energy landscape (see above for > 3 dimensions)
-pmax	real	0	Maximum probability in output, default is calculate
-gmax	real	0	Maximum free energy in output, default is calculate
-emin	real	0	Minimum enthalpy in output, default is calculate
-emax	real	0	Maximum enthalpy in output, default is calculate
-nlevels	int	25	Number of levels for energy landscape
-mname	string		Legend label for the custom landscape

D.73 g_sigeps

`g_sigeps` is a simple utility that converts C6/C12 or C6/Cn combinations to σ and ϵ , or vice versa. It can also plot the potential in file. In addition, it makes an approximation of a Buckingham potential to a Lennard-Jones potential.

Files

-o potje.xvg Output xvgr/xmgr file

Other options

-h	bool	no	Print help info and quit
-version	bool	no	Print version info and quit
-nice	int	0	Set the nicelevel
-w	bool	no	View output .xvg, .xpm, .eps and .pdb files
-xvg	enum	xmgrace	xvg plot formatting: xmgrace, xmgr or none
-c6	real	0.001	C6
-cn	real	1e-06	Constant for repulsion
-pow	int	12	Power of the repulsion term
-sig	real	0.3	σ
-eps	real	1	ϵ
-A	real	100000	Buckingham A
-B	real	32	Buckingham B
-C	real	0.001	Buckingham C
-qi	real	0	qi
-qj	real	0	qj
-sigfac	real	0.7	Factor in front of σ for starting the plot

D.74 g_sorient

`g_sorient` analyzes solvent orientation around solutes. It calculates two angles between the vector from one or more reference positions to the first atom of each solvent molecule:

θ_1 : the angle with the vector from the first atom of the solvent molecule to the midpoint between atoms 2 and 3.

θ_2 : the angle with the normal of the solvent plane, defined by the same three atoms, or, when the option `-v23` is set, the angle with the vector between atoms 2 and 3.

The reference can be a set of atoms or the center of mass of a set of atoms. The group of solvent atoms should consist of 3 atoms per solvent molecule. Only solvent molecules between `-rmin` and `-rmax` are considered for `-o` and `-no` each frame.

`-o`: distribution of $\cos(\theta_1)$ for $r_{\min} \leq r \leq r_{\max}$.

`-no`: distribution of $\cos(\theta_2)$ for $r_{\min} \leq r \leq r_{\max}$.

`-ro`: $\langle \cos(\theta_1) \rangle$ and $\langle 3 \cos^2(\theta_2) - 1 \rangle$ as a function of the distance.

`-co`: the sum over all solvent molecules within distance r of $\cos(\theta_1)$ and $3 \cos^2(\theta_2) - 1$ as a function of r .

`-rc`: the distribution of the solvent molecules as a function of r

Files

<code>-f</code>	<code>traj.xtc</code>	Input	Trajectory: xtc trr trj gro g96 pdb cpt
<code>-s</code>	<code>topol.tpr</code>	Input	Structure+mass(db): tpr tpb tpa gro g96 pdb
<code>-n</code>	<code>index.ndx</code>	Input, Opt.	Index file
<code>-o</code>	<code>sori.xvg</code>	Output	xvgr/xmgr file
<code>-no</code>	<code>snor.xvg</code>	Output	xvgr/xmgr file
<code>-ro</code>	<code>sord.xvg</code>	Output	xvgr/xmgr file
<code>-co</code>	<code>scum.xvg</code>	Output	xvgr/xmgr file
<code>-rc</code>	<code>scount.xvg</code>	Output	xvgr/xmgr file

Other options

<code>-h</code>	bool	no	Print help info and quit
<code>-version</code>	bool	no	Print version info and quit
<code>-nice</code>	int	19	Set the nicelevel
<code>-b</code>	time	0	First frame (ps) to read from trajectory
<code>-e</code>	time	0	Last frame (ps) to read from trajectory
<code>-dt</code>	time	0	Only use frame when $t \text{ MOD } dt = \text{first time (ps)}$
<code>-w</code>	bool	no	View output <code>.xvg</code> , <code>.xpm</code> , <code>.eps</code> and <code>.pdb</code> files
<code>-xvg</code>	enum	xmgrace	xvg plot formatting: xmgrace, xmgr or none
<code>-com</code>	bool	no	Use the center of mass as the reference position
<code>-v23</code>	bool	no	Use the vector between atoms 2 and 3
<code>-rmin</code>	real	0	Minimum distance (nm)
<code>-rmax</code>	real	0.5	Maximum distance (nm)
<code>-cbin</code>	real	0.02	Binwidth for the cosine
<code>-rbin</code>	real	0.02	Binwidth for r (nm)
<code>-pbc</code>	bool	no	Check PBC for the center of mass calculation. Only necessary when your reference group consists of several molecules.

D.75 *g_spatial*

`g_spatial` calculates the spatial distribution function and outputs it in a form that can be read by VMD as Gaussian98 cube format. This was developed from `template.c` (GROMACS-3.3). For a system of 32,000 atoms and a 50 ns trajectory, the SDF can be generated in about 30 minutes, with most of the time dedicated to the two runs through `trjconv` that are required to center everything properly. This also takes a whole bunch of space (3 copies of the `.xtc` file). Still, the pictures are pretty and very informative when the fitted

selection is properly made. 3-4 atoms in a widely mobile group (like a free amino acid in solution) works well, or select the protein backbone in a stable folded structure to get the SDF of solvent and look at the time-averaged solvation shell. It is also possible using this program to generate the SDF based on some arbitrary Cartesian coordinate. To do that, simply omit the preliminary `trjconv` steps.

USAGE:

1. Use `make_ndx` to create a group containing the atoms around which you want the SDF
2. `trjconv -s a.tpr -f a.xtc -o b.xtc -center tric -ur compact -pbc none`
3. `trjconv -s a.tpr -f b.xtc -o c.xtc -fit rot+trans`
4. run `g_spatial` on the `.xtc` output of step #3.
5. Load `grid.cube` into VMD and view as an isosurface.

Note that systems such as micelles will require `trjconv -pbc cluster` between steps 1 and 2

WARNINGS:

The SDF will be generated for a cube that contains all bins that have some non-zero occupancy. However, the preparatory `-fit rot+trans` option to `trjconv` implies that your system will be rotating and translating in space (in order that the selected group does not). Therefore the values that are returned will only be valid for some region around your central group/coordinate that has full overlap with system volume throughout the entire translated/rotated system over the course of the trajectory. It is up to the user to ensure that this is the case.

BUGS:

When the allocated memory is not large enough, a segmentation fault may occur. This is usually detected and the program is halted prior to the fault while displaying a warning message suggesting the use of the `-nab` (Number of Additional Bins) option. However, the program does not detect all such events. If you encounter a segmentation fault, run it again with an increased `-nab` value.

RISKY OPTIONS:

To reduce the amount of space and time required, you can output only the coords that are going to be used in the first and subsequent run through `trjconv`. However, be sure to set the `-nab` option to a sufficiently high value since memory is allocated for cube bins based on the initial coordinates and the `-nab` option value.

Files

<code>-s</code>	<code>topol.tpr</code>	Input	Structure+mass(db): <code>tpr tpb tpa gro g96 pdb</code>
<code>-f</code>	<code>traj.xtc</code>	Input	Trajectory: <code>xtc trr trj gro g96 pdb cpt</code>
<code>-n</code>	<code>index.ndx</code>	Input, Opt.	Index file

Other options

<code>-h</code>	bool	no	Print help info and quit
<code>-version</code>	bool	no	Print version info and quit
<code>-nice</code>	int	0	Set the nicelevel
<code>-b</code>	time	0	First frame (ps) to read from trajectory
<code>-e</code>	time	0	Last frame (ps) to read from trajectory
<code>-dt</code>	time	0	Only use frame when $t \text{ MOD } dt = \text{first time (ps)}$
<code>-w</code>	bool	no	View output <code>.xvg</code> , <code>.xpm</code> , <code>.eps</code> and <code>.pdb</code> files
<code>-pbc</code>	bool	no	Use periodic boundary conditions for computing distances
<code>-div</code>	bool	yes	Calculate and apply the divisor for bin occupancies based on atoms/minimal cube size. Set as TRUE for visualization and as FALSE (<code>-nodiv</code>) to get accurate counts per frame
<code>-ign</code>	int	-1	Do not display this number of outer cubes (positive values may reduce boundary speckles; -1 ensures outer surface is visible)
<code>-bin</code>	real	0.05	Width of the bins (nm)

`-nab` int 4 Number of additional bins to ensure proper memory allocation

D.76 *g_spol*

g_spol analyzes dipoles around a solute; it is especially useful for polarizable water. A group of reference atoms, or a center of mass reference (option `-com`) and a group of solvent atoms is required. The program splits the group of solvent atoms into molecules. For each solvent molecule the distance to the closest atom in reference group or to the COM is determined. A cumulative distribution of these distances is plotted. For each distance between `-rmin` and `-rmax` the inner product of the distance vector and the dipole of the solvent molecule is determined. For solvent molecules with net charge (ions), the net charge of the ion is subtracted evenly from all atoms in the selection of each ion. The average of these dipole components is printed. The same is done for the polarization, where the average dipole is subtracted from the instantaneous dipole. The magnitude of the average dipole is set with the option `-dip`, the direction is defined by the vector from the first atom in the selected solvent group to the midpoint between the second and the third atom.

Files

<code>-f</code>	<code>traj.xtc</code>	Input	Trajectory: xtc trr trj gro g96 pdb cpt
<code>-s</code>	<code>topol.tpr</code>	Input	Run input file: tpr tpb tpa
<code>-n</code>	<code>index.ndx</code>	Input, Opt.	Index file
<code>-o</code>	<code>scdist.xvg</code>	Output	xvgr/xmgr file

Other options

<code>-h</code>	bool	no	Print help info and quit
<code>-version</code>	bool	no	Print version info and quit
<code>-nice</code>	int	19	Set the nicelevel
<code>-b</code>	time	0	First frame (ps) to read from trajectory
<code>-e</code>	time	0	Last frame (ps) to read from trajectory
<code>-dt</code>	time	0	Only use frame when $t \text{ MOD } dt = \text{first time (ps)}$
<code>-w</code>	bool	no	View output <code>.xvg</code> , <code>.xpm</code> , <code>.eps</code> and <code>.pdb</code> files
<code>-xvg</code>	enum	xmgrace	xvg plot formatting: <code>xmgrace</code> , <code>xmgr</code> or <code>none</code>
<code>-com</code>	bool	no	Use the center of mass as the reference position
<code>-refat</code>	int	1	The reference atom of the solvent molecule
<code>-rmin</code>	real	0	Maximum distance (nm)
<code>-rmax</code>	real	0.32	Maximum distance (nm)
<code>-dip</code>	real	0	The average dipole (D)
<code>-bw</code>	real	0.01	The bin width

D.77 *g_tcaf*

g_tcaf computes transverse current autocorrelations. These are used to estimate the shear viscosity, η . For details see: Palmer, Phys. Rev. E 49 (1994) pp 359-366.

Transverse currents are calculated using the k-vectors (1,0,0) and (2,0,0) each also in the y- and z-direction, (1,1,0) and (1,-1,0) each also in the 2 other planes (these vectors are not independent) and (1,1,1) and the 3 other box diagonals (also not independent). For each k-vector the sine and cosine are used, in combination with the velocity in 2 perpendicular directions. This gives a total of $16 \cdot 2 \cdot 2 = 64$ transverse currents. One autocorrelation is calculated fitted for each k-vector, which gives 16 TCAFs. Each of these TCAFs is fitted to $f(t) = \exp(-v)(\cosh(Wv) + 1/W \sinh(Wv))$, $v = -t/(2\tau)$, $W = \sqrt{1 - 4\tau\eta/\rho k^2}$, which gives 16 values of τ and η . The fit weights decay exponentially with time constant w (given with `-wt`)

as $\exp(-t/w)$, and the TCAF and fit are calculated up to time $5 * w$. The η values should be fitted to $1 - a\eta(k)k^2$, from which one can estimate the shear viscosity at $k=0$.

When the box is cubic, one can use the option `-oc`, which averages the TCAFs over all k -vectors with the same length. This results in more accurate TCAFs. Both the cubic TCAFs and fits are written to `-oc`. The cubic η estimates are also written to `-ov`.

With option `-mol`, the transverse current is determined of molecules instead of atoms. In this case, the index group should consist of molecule numbers instead of atom numbers.

The k -dependent viscosities in the `-ov` file should be fitted to $\eta(k) = \eta_0(1 - ak^2)$ to obtain the viscosity at infinite wavelength.

Note: make sure you write coordinates and velocities often enough. The initial, non-exponential, part of the autocorrelation function is very important for obtaining a good fit.

Files

<code>-f</code>	<code>traj.trr</code>	Input	Full precision trajectory: trr trj cpt
<code>-s</code>	<code>topol.tpr</code>	Input, Opt.	Structure+mass(db): tpr tpb tpa gro g96 pdb
<code>-n</code>	<code>index.ndx</code>	Input, Opt.	Index file
<code>-ot</code>	<code>transcur.xvg</code>	Output, Opt.	xvgr/xmgr file
<code>-oa</code>	<code>tcaf_all.xvg</code>	Output	xvgr/xmgr file
<code>-o</code>	<code>tcaf.xvg</code>	Output	xvgr/xmgr file
<code>-of</code>	<code>tcaf_fit.xvg</code>	Output	xvgr/xmgr file
<code>-oc</code>	<code>tcaf_cub.xvg</code>	Output, Opt.	xvgr/xmgr file
<code>-ov</code>	<code>visc_k.xvg</code>	Output	xvgr/xmgr file

Other options

<code>-h</code>	bool	no	Print help info and quit
<code>-version</code>	bool	no	Print version info and quit
<code>-nice</code>	int	19	Set the nicelevel
<code>-b</code>	time	0	First frame (ps) to read from trajectory
<code>-e</code>	time	0	Last frame (ps) to read from trajectory
<code>-dt</code>	time	0	Only use frame when $t \text{ MOD } dt = \text{first time (ps)}$
<code>-w</code>	bool	no	View output <code>.xvg</code> , <code>.xpm</code> , <code>.eps</code> and <code>.pdb</code> files
<code>-xvg</code>	enum	xmgrace	xvg plot formatting: <code>xmgrace</code> , <code>xmgr</code> or <code>none</code>
<code>-mol</code>	bool	no	Calculate TCAF of molecules
<code>-k34</code>	bool	no	Also use $k=(3,0,0)$ and $k=(4,0,0)$
<code>-wt</code>	real	5	Exponential decay time for the TCAF fit weights
<code>-acflen</code>	int	-1	Length of the ACF, default is half the number of frames
<code>-normalize</code>	bool	yes	Normalize ACF
<code>-P</code>	enum	0	Order of Legendre polynomial for ACF (0 indicates none): 0, 1, 2 or 3
<code>-fitfn</code>	enum	none	Fit function: <code>none</code> , <code>exp</code> , <code>aexp</code> , <code>exp_exp</code> , <code>vac</code> , <code>exp5</code> , <code>exp7</code> , <code>exp9</code> or <code>erffit</code>
<code>-ncskip</code>	int	0	Skip this many points in the output file of correlation functions
<code>-beginfit</code>	real	0	Time where to begin the exponential fit of the correlation function
<code>-endfit</code>	real	-1	Time where to end the exponential fit of the correlation function, -1 is until the end

D.78 g_traj

`g_traj` plots coordinates, velocities, forces and/or the box. With `-com` the coordinates, velocities and forces are calculated for the center of mass of each group. When `-mol` is set, the numbers in the index file are interpreted as molecule numbers and the same procedure as with `-com` is used for each molecule.

Option `-ot` plots the temperature of each group, provided velocities are present in the trajectory file. No corrections are made for constrained degrees of freedom! This implies `-com`.

Options `-ekt` and `-ekr` plot the translational and rotational kinetic energy of each group, provided velocities are present in the trajectory file. This implies `-com`.

Options `-cv` and `-cf` write the average velocities and average forces as temperature factors to a `.pdb` file with the average coordinates or the coordinates at `-ctime`. The temperature factors are scaled such that the maximum is 10. The scaling can be changed with the option `-scale`. To get the velocities or forces of one frame set both `-b` and `-e` to the time of desired frame. When averaging over frames you might need to use the `-nojump` option to obtain the correct average coordinates. If you select either of these options the average force and velocity for each atom are written to an `.xvg` file as well (specified with `-av` or `-af`).

Option `-vd` computes a velocity distribution, i.e. the norm of the vector is plotted. In addition in the same graph the kinetic energy distribution is given.

Files

<code>-f</code>	<code>traj.xtc</code>	Input	Trajectory: <code>xtc trr trj gro g96 pdb cpt</code>
<code>-s</code>	<code>topol.tpr</code>	Input	Structure+mass(db): <code>tpr tpb tpa gro g96 pdb</code>
<code>-n</code>	<code>index.ndx</code>	Input, Opt.	Index file
<code>-ox</code>	<code>coord.xvg</code>	Output, Opt.	<code>xvgr/xmgr</code> file
<code>-oxt</code>	<code>coord.xtc</code>	Output, Opt.	Trajectory: <code>xtc trr trj gro g96 pdb cpt</code>
<code>-ov</code>	<code>veloc.xvg</code>	Output, Opt.	<code>xvgr/xmgr</code> file
<code>-of</code>	<code>force.xvg</code>	Output, Opt.	<code>xvgr/xmgr</code> file
<code>-ob</code>	<code>box.xvg</code>	Output, Opt.	<code>xvgr/xmgr</code> file
<code>-ot</code>	<code>temp.xvg</code>	Output, Opt.	<code>xvgr/xmgr</code> file
<code>-ekt</code>	<code>ektrans.xvg</code>	Output, Opt.	<code>xvgr/xmgr</code> file
<code>-ekr</code>	<code>ekrot.xvg</code>	Output, Opt.	<code>xvgr/xmgr</code> file
<code>-vd</code>	<code>veldist.xvg</code>	Output, Opt.	<code>xvgr/xmgr</code> file
<code>-cv</code>	<code>veloc.pdb</code>	Output, Opt.	Protein data bank file
<code>-cf</code>	<code>force.pdb</code>	Output, Opt.	Protein data bank file
<code>-av</code>	<code>all_veloc.xvg</code>	Output, Opt.	<code>xvgr/xmgr</code> file
<code>-af</code>	<code>all_force.xvg</code>	Output, Opt.	<code>xvgr/xmgr</code> file

Other options

<code>-h</code>	bool	no	Print help info and quit
<code>-version</code>	bool	no	Print version info and quit
<code>-nice</code>	int	19	Set the nicelevel
<code>-b</code>	time	0	First frame (ps) to read from trajectory
<code>-e</code>	time	0	Last frame (ps) to read from trajectory
<code>-dt</code>	time	0	Only use frame when $t \text{ MOD } dt = \text{first time (ps)}$
<code>-tu</code>	enum	ps	Time unit: <code>fs, ps, ns, us, ms</code> or <code>s</code>
<code>-w</code>	bool	no	View output <code>.xvg</code> , <code>.xpm</code> , <code>.eps</code> and <code>.pdb</code> files
<code>-xvg</code>	enum	<code>xmgrace</code>	<code>xvg</code> plot formatting: <code>xmgrace</code> , <code>xmgr</code> or <code>none</code>
<code>-com</code>	bool	no	Plot data for the com of each group
<code>-pbc</code>	bool	yes	Make molecules whole for COM
<code>-mol</code>	bool	no	Index contains molecule numbers iso atom numbers
<code>-nojump</code>	bool	no	Remove jumps of atoms across the box
<code>-x</code>	bool	yes	Plot X-component
<code>-y</code>	bool	yes	Plot Y-component
<code>-z</code>	bool	yes	Plot Z-component
<code>-ng</code>	int	1	Number of groups to consider
<code>-len</code>	bool	no	Plot vector length
<code>-fp</code>	bool	no	Full precision output
<code>-bin</code>	real	1	Binwidth for velocity histogram (nm/ps)

```
-ctime  real    -1  Use frame at this time for x in -cv and -cf instead of the average x
-scale  real     0  Scale factor for .pdb output, 0 is autoscale
```

D.79 g_tune_pme

For a given number `-np` or `-ntmpi` of processors/threads, this program systematically times `mdrun` with various numbers of PME-only nodes and determines which setting is fastest. It will also test whether performance can be enhanced by shifting load from the reciprocal to the real space part of the Ewald sum. Simply pass your `.tpr` file to `g_tune_pme` together with other options for `mdrun` as needed.

Which executables are used can be set in the environment variables `MPIRUN` and `MDRUN`. If these are not present, `'mpirun'` and `'mdrun'` will be used as defaults. Note that for certain MPI frameworks you need to provide a machine- or hostfile. This can also be passed via the `MPIRUN` variable, e.g.

```
export MPIRUN="/usr/local/mpirun -machinefile hosts"
```

Please call `g_tune_pme` with the normal options you would pass to `mdrun` and add `-np` for the number of processors to perform the tests on, or `-ntmpi` for the number of threads. You can also add `-r` to repeat each test several times to get better statistics.

`g_tune_pme` can test various real space / reciprocal space workloads for you. With `-ntpr` you control how many extra `.tpr` files will be written with enlarged cutoffs and smaller Fourier grids respectively. Typically, the first test (number 0) will be with the settings from the input `.tpr` file; the last test (number `ntpr`) will have the Coulomb cutoff specified by `-rmax` with a somewhat smaller PME grid at the same time. In this last test, the Fourier spacing is multiplied with `rmax/rcoulomb`. The remaining `.tpr` files will have equally-spaced Coulomb radii (and Fourier spacings) between these extremes. **Note** that you can set `-ntpr` to 1 if you just seek the optimal number of PME-only nodes; in that case your input `.tpr` file will remain unchanged.

For the benchmark runs, the default of 1000 time steps should suffice for most MD systems. The dynamic load balancing needs about 100 time steps to adapt to local load imbalances, therefore the time step counters are by default reset after 100 steps. For large systems (>1M atoms), as well as for a higher accuracy of the measurements, you should set `-resetstep` to a higher value. From the 'DD' load imbalance entries in the `md.log` output file you can tell after how many steps the load is sufficiently balanced. Example call:

```
g_tune_pme -np 64 -s protein.tpr -launch
```

After calling `mdrun` several times, detailed performance information is available in the output file `perf.out`. **Note** that during the benchmarks, a couple of temporary files are written (options `-b*`), these will be automatically deleted after each test.

If you want the simulation to be started automatically with the optimized parameters, use the command line option `-launch`.

Files

<code>-p</code>	<code>perf.out</code>	Output	Generic output file
<code>-err</code>	<code>bencherr.log</code>	Output	Log file
<code>-so</code>	<code>tuned.tpr</code>	Output	Run input file: <code>tpr tpb tpa</code>
<code>-s</code>	<code>topol.tpr</code>	Input	Run input file: <code>tpr tpb tpa</code>
<code>-o</code>	<code>traj.trr</code>	Output	Full precision trajectory: <code>trr trj cpt</code>
<code>-x</code>	<code>traj.xtc</code>	Output, Opt.	Compressed trajectory (portable xdr format)
<code>-cpi</code>	<code>state.cpt</code>	Input, Opt.	Checkpoint file
<code>-cpo</code>	<code>state.cpt</code>	Output, Opt.	Checkpoint file
<code>-c</code>	<code>confout.gro</code>	Output	Structure file: <code>gro g96 pdb</code> etc.
<code>-e</code>	<code>ener.edr</code>	Output	Energy file

-g	md.log	Output	Log file
-dhdl	dhdl.xvg	Output, Opt.	xvgr/xmgr file
-field	field.xvg	Output, Opt.	xvgr/xmgr file
-table	table.xvg	Input, Opt.	xvgr/xmgr file
-tabletf	tabletf.xvg	Input, Opt.	xvgr/xmgr file
-tablep	tablep.xvg	Input, Opt.	xvgr/xmgr file
-tableb	table.xvg	Input, Opt.	xvgr/xmgr file
-rerun	rerun.xtc	Input, Opt.	Trajectory: xtc trr trj gro g96 pdb cpt
-tpi	tpi.xvg	Output, Opt.	xvgr/xmgr file
-tpid	tpidist.xvg	Output, Opt.	xvgr/xmgr file
-ei	sam.edi	Input, Opt.	ED sampling input
-eo	edsam.xvg	Output, Opt.	xvgr/xmgr file
-j	wham.gct	Input, Opt.	General coupling stuff
-jo	bam.gct	Output, Opt.	General coupling stuff
-ffout	gct.xvg	Output, Opt.	xvgr/xmgr file
-devout	deviatie.xvg	Output, Opt.	xvgr/xmgr file
-runav	runaver.xvg	Output, Opt.	xvgr/xmgr file
-px	pullx.xvg	Output, Opt.	xvgr/xmgr file
-pf	pullf.xvg	Output, Opt.	xvgr/xmgr file
-ro	rotation.xvg	Output, Opt.	xvgr/xmgr file
-ra	rotangles.log	Output, Opt.	Log file
-rs	rotslabs.log	Output, Opt.	Log file
-rt	rottorque.log	Output, Opt.	Log file
-mtx	nm.mtx	Output, Opt.	Hessian matrix
-dn	dipole.ndx	Output, Opt.	Index file
-bo	bench.trr	Output	Full precision trajectory: trr trj cpt
-bx	bench.xtc	Output	Compressed trajectory (portable xdr format)
-bcpo	bench.cpt	Output	Checkpoint file
-bc	bench.gro	Output	Structure file: gro g96 pdb etc.
-be	bench.edr	Output	Energy file
-bg	bench.log	Output	Log file
-beo	benchedo.xvg	Output, Opt.	xvgr/xmgr file
-bdhdl	benchdhdl.xvg	Output, Opt.	xvgr/xmgr file
-bfield	benchfld.xvg	Output, Opt.	xvgr/xmgr file
-btpi	benchtpi.xvg	Output, Opt.	xvgr/xmgr file
-btpid	benchtpid.xvg	Output, Opt.	xvgr/xmgr file
-bjo	bench.gct	Output, Opt.	General coupling stuff
-bffout	benchgct.xvg	Output, Opt.	xvgr/xmgr file
-bdevout	benchdev.xvg	Output, Opt.	xvgr/xmgr file
-brunav	benchrnav.xvg	Output, Opt.	xvgr/xmgr file
-bpx	benchpx.xvg	Output, Opt.	xvgr/xmgr file
-bpf	benchpf.xvg	Output, Opt.	xvgr/xmgr file
-bro	benchrot.xvg	Output, Opt.	xvgr/xmgr file
-bra	benchrota.log	Output, Opt.	Log file
-brs	benchrots.log	Output, Opt.	Log file
-brt	benchrott.log	Output, Opt.	Log file
-bmtx	benchn.mtx	Output, Opt.	Hessian matrix
-bdn	bench.ndx	Output, Opt.	Index file

Other options

-h	bool	no	Print help info and quit
-version	bool	no	Print version info and quit

-nice	int	0	Set the nicelevel
-xvg	enum	xmgrace	xvg plot formatting: xmgrace, xmgr or none
-np	int	1	Number of nodes to run the tests on (must be > 2 for separate PME nodes)
-npstring	enum	-np	Specify the number of processors to \$MPIRUN using this string: -np, -n or none
-ntmpi	int	1	Number of MPI-threads to run the tests on (turns MPI & mpirun off)
-r	int	2	Repeat each test this often
-max	real	0.5	Max fraction of PME nodes to test with
-min	real	0.25	Min fraction of PME nodes to test with
-npme	enum	auto	Within -min and -max, benchmark all possible values for -npme, or just a reasonable subset. Auto neglects -min and -max and chooses reasonable values around a guess for npme derived from the .tpr: auto, all or subset
-fix	int	-2	If ≥ -1 , do not vary the number of PME-only nodes, instead use this fixed value and only vary rcoulomb and the PME grid spacing.
-rmax	real	0	If >0, maximal rcoulomb for -ntpr>1 (rcoulomb upscaling results in fourier grid downscaling)
-rmin	real	0	If >0, minimal rcoulomb for -ntpr>1
-scalevdw	bool	yes	Scale rvdw along with rcoulomb
-ntpr	int	0	Number of .tpr files to benchmark. Create this many files with different rcoulomb scaling factors depending on -rmin and -rmax. If < 1, automatically choose the number of .tpr files to test
-steps	step	1000	Take timings for this many steps in the benchmark runs
-resetstep	int	100	Let dlb equilibrate this many steps before timings are taken (reset cycle counters after this many steps)
-simsteps	step	-1	If non-negative, perform this many steps in the real run (overwrites nsteps from .tpr, add .cpt steps)
-launch	bool	no	Launch the real simulation after optimization
-bench	bool	yes	Run the benchmarks or just create the input .tpr files?
-append	bool	yes	Append to previous output files when continuing from checkpoint instead of adding the simulation part number to all file names (for launch only)
-cpnum	bool	no	Keep and number checkpoint files (launch only)

D.80 g_vanhove

`g_vanhove` computes the Van Hove correlation function. The Van Hove $G(r,t)$ is the probability that a particle that is at r_0 at time zero can be found at position r_0+r at time t . `g_vanhove` determines G not for a vector r , but for the length of r . Thus it gives the probability that a particle moves a distance of r in time t . Jumps across the periodic boundaries are removed. Corrections are made for scaling due to isotropic or anisotropic pressure coupling.

With option `-om` the whole matrix can be written as a function of t and r or as a function of \sqrt{t} and r (option `-sqrt`).

With option `-or` the Van Hove function is plotted for one or more values of t . Option `-nr` sets the number of times, option `-fr` the number spacing between the times. The binwidth is set with option `-rbin`. The number of bins is determined automatically.

With option `-ot` the integral up to a certain distance (option `-rt`) is plotted as a function of time.

For all frames that are read the coordinates of the selected particles are stored in memory. Therefore the program may use a lot of memory. For options `-om` and `-ot` the program may be slow. This is because the calculation scales as the number of frames times `-fm` or `-ft`. Note that with the `-dt` option the memory

usage and calculation time can be reduced.

Files

-f	traj.xtc	Input	Trajectory: xtc trr trj gro g96 pdb cpt
-s	topol.tpr	Input	Structure+mass(db): tpr tpb tpa gro g96 pdb
-n	index.ndx	Input, Opt.	Index file
-om	vanhove.xpm	Output, Opt.	X PixMap compatible matrix file
-or	vanhove_r.xvg	Output, Opt.	xvgr/xmgr file
-ot	vanhove_t.xvg	Output, Opt.	xvgr/xmgr file

Other options

-h	bool	no	Print help info and quit
-version	bool	no	Print version info and quit
-nice	int	19	Set the nicelevel
-b	time	0	First frame (ps) to read from trajectory
-e	time	0	Last frame (ps) to read from trajectory
-dt	time	0	Only use frame when t MOD dt = first time (ps)
-w	bool	no	View output .xvg, .xpm, .eps and .pdb files
-xvg	enum	xmgrace	xvg plot formatting: xmgrace, xmgr or none
-sqrt	real	0	Use \sqrt{t} on the matrix axis which binspacing # in \sqrt{ps}
-fm	int	0	Number of frames in the matrix, 0 is plot all
-rmax	real	2	Maximum r in the matrix (nm)
-rbin	real	0.01	Binwidth in the matrix and for -or (nm)
-mmax	real	0	Maximum density in the matrix, 0 is calculate (1/nm)
-nlevels	int	81	Number of levels in the matrix
-nr	int	1	Number of curves for the -or output
-fr	int	0	Frame spacing for the -or output
-rt	real	0	Integration limit for the -ot output (nm)
-ft	int	0	Number of frames in the -ot output, 0 is plot all

D.81 *g_velacc*

g_velacc computes the velocity autocorrelation function. When the -m option is used, the momentum autocorrelation function is calculated.

With option -mol the velocity autocorrelation function of molecules is calculated. In this case the index group should consist of molecule numbers instead of atom numbers.

Be sure that your trajectory contains frames with velocity information (i.e. nstvout was set in your original .mdp file), and that the time interval between data collection points is much shorter than the time scale of the autocorrelation.

Files

-f	traj.trr	Input	Full precision trajectory: trr trj cpt
-s	topol.tpr	Input, Opt.	Structure+mass(db): tpr tpb tpa gro g96 pdb
-n	index.ndx	Input, Opt.	Index file
-o	vac.xvg	Output	xvgr/xmgr file
-os	spectrum.xvg	Output, Opt.	xvgr/xmgr file

Other options

-h	bool	no	Print help info and quit
-version	bool	no	Print version info and quit
-nice	int	19	Set the nicelevel

-b	time	0	First frame (ps) to read from trajectory
-e	time	0	Last frame (ps) to read from trajectory
-dt	time	0	Only use frame when $t \text{ MOD } dt = \text{first time (ps)}$
-w	bool	no	View output <code>.xvg</code> , <code>.xpm</code> , <code>.eps</code> and <code>.pdb</code> files
-xvg	enum	xmgrace	xvg plot formatting: <code>xmgrace</code> , <code>xmgr</code> or <code>none</code>
-m	bool	no	Calculate the momentum autocorrelation function
-recip	bool	yes	Use cm^{-1} on X-axis instead of $1/\text{ps}$ for spectra.
-mol	bool	no	Calculate the velocity acf of molecules
-acflen	int	-1	Length of the ACF, default is half the number of frames
-normalize	bool	yes	Normalize ACF
-P	enum	0	Order of Legendre polynomial for ACF (0 indicates none): 0, 1, 2 or 3
-fitfn	enum	none	Fit function: <code>none</code> , <code>exp</code> , <code>aexp</code> , <code>exp_exp</code> , <code>vac</code> , <code>exp5</code> , <code>exp7</code> , <code>exp9</code> or <code>erffit</code>
-ncskip	int	0	Skip this many points in the output file of correlation functions
-beginfit	real	0	Time where to begin the exponential fit of the correlation function
-endfit	real	-1	Time where to end the exponential fit of the correlation function, -1 is until the end

D.82 g_wham

This is an analysis program that implements the Weighted Histogram Analysis Method (WHAM). It is intended to analyze output files generated by umbrella sampling simulations to compute a potential of mean force (PMF).

At present, three input modes are supported.

* With option `-it`, the user provides a file which contains the file names of the umbrella simulation run-input files (`.tpr` files), AND, with option `-ix`, a file which contains file names of the pullx `mdrun` output files. The `.tpr` and pullx files must be in corresponding order, i.e. the first `.tpr` created the first pullx, etc.

* Same as the previous input mode, except that the the user provides the pull force output file names (`pullf.xvg`) with option `-if`. From the pull force the position in the umbrella potential is computed. This does not work with tabulated umbrella potentials.

* With option `-ip`, the user provides file names of (gzipped) `.pdo` files, i.e. the GROMACS 3.3 umbrella output files. If you have some unusual reaction coordinate you may also generate your own `.pdo` files and feed them with the `-ip` option into to `g_wham`. The `.pdo` file header must be similar to the following:

```
# UMBRELLA 3.0
# Component selection:  0 0 1
# nSkip 1
# Ref.  Group 'TestAtom'
# Nr.  of pull groups 2
# Group 1 'GR1' Umb.  Pos.  5.0 Umb.  Cons.  1000.0
# Group 2 'GR2' Umb.  Pos.  2.0 Umb.  Cons.  500.0
#####
```

The number of pull groups, umbrella positions, force constants, and names may (of course) differ. Following the header, a time column and a data column for each pull group follows (i.e. the displacement with respect to the umbrella center). Up to four pull groups are possible per `.pdo` file at present.

By default, the output files are

`-o` PMF output file

`-hist` Histograms output file

Always check whether the histograms sufficiently overlap.

The umbrella potential is assumed to be harmonic and the force constants are read from the `.tpr` or `.pdo` files. If a non-harmonic umbrella force was applied a tabulated potential can be provided with `-tab`.

WHAM OPTIONS

`-bins` Number of bins used in analysis
`-temp` Temperature in the simulations
`-tol` Stop iteration if profile (probability) changed less than tolerance
`-auto` Automatic determination of boundaries
`-min, -max` Boundaries of the profile

The data points that are used to compute the profile can be restricted with options `-b`, `-e`, and `-dt`. Adjust `-b` to ensure sufficient equilibration in each umbrella window.

With `-log` (default) the profile is written in energy units, otherwise (with `-nolog`) as probability. The unit can be specified with `-unit`. With energy output, the energy in the first bin is defined to be zero. If you want the free energy at a different position to be zero, set `-zprof0` (useful with bootstrapping, see below).

For cyclic or periodic reaction coordinates (dihedral angle, channel PMF without osmotic gradient), the option `-cycl` is useful. *g_wham* will make use of the periodicity of the system and generate a periodic PMF. The first and the last bin of the reaction coordinate will assumed be neighbors.

Option `-sym` symmetrizes the profile around $z=0$ before output, which may be useful for, e.g. membranes.

AUTOCORRELATIONS

With `-ac`, *g_wham* estimates the integrated autocorrelation time (IACT) τ for each umbrella window and weights the respective window with $1/[1+2*\tau/dt]$. The IACTs are written to the file defined with `-oiact`. In verbose mode, all autocorrelation functions (ACFs) are written to `hist_autocorr.xvg`. Because the IACTs can be severely underestimated in case of limited sampling, option `-acsig` allows one to smooth the IACTs along the reaction coordinate with a Gaussian (σ provided with `-acsig`, see output in `iact.xvg`). Note that the IACTs are estimated by simple integration of the ACFs while the ACFs are larger 0.05. If you prefer to compute the IACTs by a more sophisticated (but possibly less robust) method such as fitting to a double exponential, you can compute the IACTs with *g_analyze* and provide them to *g_wham* with the file `iact-in.dat` (option `-iiact`), which should contain one line per input file (`.pdo` or `pullx/f` file) and one column per pull group in the respective file.

ERROR ANALYSIS

Statistical errors may be estimated with bootstrap analysis. Use it with care, otherwise the statistical error may be substantially underestimated. More background and examples for the bootstrap technique can be found in Hub, de Groot and Van der Spoel, JCTC (2010) 6: 3713-3720.

`-nBootstrap` defines the number of bootstraps (use, e.g., 100). Four bootstrapping methods are supported and selected with `-bs-method`.

(1) `b-hist` Default: complete histograms are considered as independent data points, and the bootstrap is carried out by assigning random weights to the histograms ("Bayesian bootstrap"). Note that each point along the reaction coordinate must be covered by multiple independent histograms (e.g. 10 histograms), otherwise the statistical error is underestimated.

(2) `hist` Complete histograms are considered as independent data points. For each bootstrap, N histograms are randomly chosen from the N given histograms (allowing duplication, i.e. sampling with replacement). To avoid gaps without data along the reaction coordinate blocks of histograms (`-histbs-block`) may be defined. In that case, the given histograms are divided into blocks and only histograms within each block are mixed. Note that the histograms within each block must be representative for all possible histograms, otherwise the statistical error is underestimated.

(3) `traj` The given histograms are used to generate new random trajectories, such that the generated data

points are distributed according the given histograms and properly autocorrelated. The autocorrelation time (ACT) for each window must be known, so use `-ac` or provide the ACT with `-iiact`. If the ACT of all windows are identical (and known), you can also provide them with `-bs-tau`. Note that this method may severely underestimate the error in case of limited sampling, that is if individual histograms do not represent the complete phase space at the respective positions.

(4) `traj-gauss` The same as method `traj`, but the trajectories are not bootstrapped from the umbrella histograms but from Gaussians with the average and width of the umbrella histograms. That method yields similar error estimates like method `traj`.

Bootstrapping output:

`-bsres` Average profile and standard deviations

`-bsprof` All bootstrapping profiles

With `-vbs` (verbose bootstrapping), the histograms of each bootstrap are written, and, with bootstrap method `traj`, the cumulative distribution functions of the histograms.

Files

<code>-ixpullx-files.dat</code>	Input, Opt.	Generic data file
<code>-ifpullf-files.dat</code>	Input, Opt.	Generic data file
<code>-it tpr-files.dat</code>	Input, Opt.	Generic data file
<code>-ip pdo-files.dat</code>	Input, Opt.	Generic data file
<code>-o profile.svg</code>	Output	xvgr/xmgr file
<code>-hist histo.svg</code>	Output	xvgr/xmgr file
<code>-oiact iact.svg</code>	Output, Opt.	xvgr/xmgr file
<code>-iiact iact-in.dat</code>	Input, Opt.	Generic data file
<code>-bsres bsResult.svg</code>	Output, Opt.	xvgr/xmgr file
<code>-bsprof bsProfs.svg</code>	Output, Opt.	xvgr/xmgr file
<code>-tab umb-pot.dat</code>	Input, Opt.	Generic data file

Other options

<code>-h</code>	bool	no	Print help info and quit
<code>-version</code>	bool	no	Print version info and quit
<code>-nice</code>	int	19	Set the nicelevel
<code>-xvg</code>	enum	xmgrace	xvg plot formatting: <code>xmgrace</code> , <code>xmgr</code> or <code>none</code>
<code>-min</code>	real	0	Minimum coordinate in profile
<code>-max</code>	real	0	Maximum coordinate in profile
<code>-auto</code>	bool	yes	Determine min and max automatically
<code>-bins</code>	int	200	Number of bins in profile
<code>-temp</code>	real	298	Temperature
<code>-tol</code>	real	1e-06	Tolerance
<code>-v</code>	bool	no	Verbose mode
<code>-b</code>	real	50	First time to analyse (ps)
<code>-e</code>	real	1e+20	Last time to analyse (ps)
<code>-dt</code>	real	0	Analyse only every dt ps
<code>-histonly</code>	bool	no	Write histograms and exit
<code>-boundsonly</code>	bool	no	Determine min and max and exit (with <code>-auto</code>)
<code>-log</code>	bool	yes	Calculate the log of the profile before printing
<code>-unit</code>	enum	kJ	Energy unit in case of log output: <code>kJ</code> , <code>kCal</code> or <code>kT</code>
<code>-zprof0</code>	real	0	Define profile to 0.0 at this position (with <code>-log</code>)
<code>-cycl</code>	bool	no	Create cyclic/periodic profile. Assumes min and max are the same point.
<code>-sym</code>	bool	no	Symmetrize profile around $z=0$
<code>-ac</code>	bool	no	Calculate integrated autocorrelation times and use in wham
<code>-acsig</code>	real	0	Smooth autocorrelation times along reaction coordinate with Gaussian of this σ
<code>-ac-trestart</code>	real	1	When computing autocorrelation functions, restart computing every .. (ps)

<code>-nBootstrap</code>	<code>int</code>	<code>0</code>	nr of bootstraps to estimate statistical uncertainty (e.g., 200)
<code>-bs-method</code>	<code>enum</code>	<code>b-hist</code>	Bootstrap method: <code>b-hist</code> , <code>hist</code> , <code>traj</code> or <code>traj-gauss</code>
<code>-bs-tau</code>	<code>real</code>	<code>0</code>	Autocorrelation time (ACT) assumed for all histograms. Use option <code>-ac</code> if ACT is unknown.
<code>-bs-seed</code>	<code>int</code>	<code>-1</code>	Seed for bootstrapping. (-1 = use time)
<code>-histbs-block</code>	<code>int</code>	<code>8</code>	When mixing histograms only mix within blocks of <code>-histbs-block</code> .
<code>-vbs</code>	<code>bool</code>	<code>no</code>	Verbose bootstrapping. Print the CDFs and a histogram file for each bootstrap.

D.83 *g_wheel*

g_wheel plots a helical wheel representation of your sequence. The input sequence is in the `.dat` file where the first line contains the number of residues and each consecutive line contains a residue name.

Files

<code>-f</code>	<code>nnnice.dat</code>	Input	Generic data file
<code>-o</code>	<code>plot.eps</code>	Output	Encapsulated PostScript (tm) file

Other options

<code>-h</code>	<code>bool</code>	<code>no</code>	Print help info and quit
<code>-version</code>	<code>bool</code>	<code>no</code>	Print version info and quit
<code>-nice</code>	<code>int</code>	<code>19</code>	Set the nicelevel
<code>-r0</code>	<code>int</code>	<code>1</code>	The first residue number in the sequence
<code>-rot0</code>	<code>real</code>	<code>0</code>	Rotate around an angle initially (90 degrees makes sense)
<code>-T</code>	<code>string</code>		Plot a title in the center of the wheel (must be shorter than 10 characters, or it will overwrite the wheel)
<code>-nn</code>	<code>bool</code>	<code>yes</code>	Toggle numbers

D.84 *g_x2top*

g_x2top generates a primitive topology from a coordinate file. The program assumes all hydrogens are present when defining the hybridization from the atom name and the number of bonds. The program can also make an `.rtp` entry, which you can then add to the `.rtp` database.

When `-param` is set, equilibrium distances and angles and force constants will be printed in the topology for all interactions. The equilibrium distances and angles are taken from the input coordinates, the force constant are set with command line options. The force fields somewhat supported currently are:

G53a5 GROMOS96 53a5 Forcefield (official distribution)

oplsaa OPLS-AA/L all-atom force field (2001 aminoacid dihedrals)

The corresponding data files can be found in the library directory with name `atomname2type.n2t`. Check Chapter 5 of the manual for more information about file formats. By default, the force field selection is interactive, but you can use the `-ff` option to specify one of the short names above on the command line instead. In that case *g_x2top* just looks for the corresponding file.

Files

<code>-f</code>	<code>conf.gro</code>	Input	Structure file: <code>gro</code> <code>g96</code> <code>pdb</code> <code>tpr</code> etc.
<code>-o</code>	<code>out.top</code>	Output, Opt.	Topology file
<code>-r</code>	<code>out.rtp</code>	Output, Opt.	Residue Type file used by <code>pdb2gmX</code>

Other options

-h	bool	no	Print help info and quit
-version	bool	no	Print version info and quit
-nice	int	0	Set the nicelevel
-ff	string	oplsaa	Force field for your simulation. Type "select" for interactive selection.
-v	bool	no	Generate verbose output in the top file.
-nexcl	int	3	Number of exclusions
-H14	bool	yes	Use 3rd neighbour interactions for hydrogen atoms
-alldih	bool	no	Generate all proper dihedrals
-remdih	bool	no	Remove dihedrals on the same bond as an improper
-pairs	bool	yes	Output 1-4 interactions (pairs) in topology file
-name	string	ICE	Name of your molecule
-pbc	bool	yes	Use periodic boundary conditions.
-pdbq	bool	no	Use the B-factor supplied in a .pdb file for the atomic charges
-param	bool	yes	Print parameters in the output
-round	bool	yes	Round off measured values
-kb	real	400000	Bonded force constant (kJ/mol/nm ²)
-kt	real	400	Angle force constant (kJ/mol/rad ²)
-kp	real	5	Dihedral angle force constant (kJ/mol/rad ²)

- The atom type selection is primitive. Virtually no chemical knowledge is used
- Periodic boundary conditions screw up the bonding
- No improper dihedrals are generated
- The atoms to atomtype translation table is incomplete (`atomname2type.n2t` file in the data directory). Please extend it and send the results back to the GROMACS crew.

D.85 g_xrama

`g_xrama` shows a Ramachandran movie, that is, it shows the Phi/Psi angles as a function of time in an X-Window.

Static Phi/Psi plots for printing can be made with `g_rama`.

Some of the more common X command line options can be used:

`-bg`, `-fg` change colors, `-font fontname`, changes the font.

Files

-f	traj.xtc	Input	Trajectory: xtc trr trj gro g96 pdb cpt
-s	topol.tpr	Input	Run input file: tpr tpb tpa

Other options

-h	bool	no	Print help info and quit
-version	bool	no	Print version info and quit
-nice	int	0	Set the nicelevel
-b	time	0	First frame (ps) to read from trajectory
-e	time	0	Last frame (ps) to read from trajectory
-dt	time	0	Only use frame when $t \text{ MOD } dt = \text{first time (ps)}$

D.86 *make_edi*

make_edi generates an essential dynamics (ED) sampling input file to be used with *mdrun* based on eigenvectors of a covariance matrix (*g_covar*) or from a normal modes analysis (*g_nmeig*). ED sampling can be used to manipulate the position along collective coordinates (eigenvectors) of (biological) macromolecules during a simulation. Particularly, it may be used to enhance the sampling efficiency of MD simulations by stimulating the system to explore new regions along these collective coordinates. A number of different algorithms are implemented to drive the system along the eigenvectors (*-linfix*, *-linacc*, *-radfix*, *-radacc*, *-radcon*), to keep the position along a certain (set of) coordinate(s) fixed (*-linfix*), or to only monitor the projections of the positions onto these coordinates (*-mon*).

References:

A. Amadei, A.B.M. Linssen, B.L. de Groot, D.M.F. van Aalten and H.J.C. Berendsen; An efficient method for sampling the essential subspace of proteins., *J. Biomol. Struct. Dyn.* 13:615-626 (1996)

B.L. de Groot, A. Amadei, D.M.F. van Aalten and H.J.C. Berendsen; Towards an exhaustive sampling of the configurational spaces of the two forms of the peptide hormone guanylin, *J. Biomol. Struct. Dyn.* 13 : 741-751 (1996)

B.L. de Groot, A. Amadei, R.M. Scheek, N.A.J. van Nuland and H.J.C. Berendsen; An extended sampling of the configurational space of HPr from *E. coli* Proteins: *Struct. Funct. Gen.* 26: 314-322 (1996)

You will be prompted for one or more index groups that correspond to the eigenvectors, reference structure, target positions, etc.

-mon: monitor projections of the coordinates onto selected eigenvectors.

-linfix: perform fixed-step linear expansion along selected eigenvectors.

-linacc: perform acceptance linear expansion along selected eigenvectors. (steps in the desired directions will be accepted, others will be rejected).

-radfix: perform fixed-step radius expansion along selected eigenvectors.

-radacc: perform acceptance radius expansion along selected eigenvectors. (steps in the desired direction will be accepted, others will be rejected). **Note:** by default the starting MD structure will be taken as origin of the first expansion cycle for radius expansion. If *-ori* is specified, you will be able to read in a structure file that defines an external origin.

-radcon: perform acceptance radius contraction along selected eigenvectors towards a target structure specified with *-tar*.

NOTE: each eigenvector can be selected only once.

-outfrq: frequency (in steps) of writing out projections etc. to *.xvg* file

-slope: minimal slope in acceptance radius expansion. A new expansion cycle will be started if the spontaneous increase of the radius (in nm/step) is less than the value specified.

-maxedsteps: maximum number of steps per cycle in radius expansion before a new cycle is started.

Note on the parallel implementation: since ED sampling is a 'global' thing (collective coordinates etc.), at least on the 'protein' side, ED sampling is not very parallel-friendly from an implementation point of view. Because parallel ED requires some extra communication, expect the performance to be lower as in a free MD simulation, especially on a large number of nodes and/or when the ED group contains a lot of atoms.

Please also note that if your ED group contains more than a single protein, then the *.tpr* file must contain the correct PBC representation of the ED group. Take a look on the initial RMSD from the reference structure, which is printed out at the start of the simulation; if this is much higher than expected, one of the ED molecules might be shifted by a box vector.

All ED-related output of *mdrun* (specify with *-eo*) is written to a *.xvg* file as a function of time in intervals of *OUTFRQ* steps.

Note that you can impose multiple ED constraints and flooding potentials in a single simulation (on different molecules) if several `.edi` files were concatenated first. The constraints are applied in the order they appear in the `.edi` file. Depending on what was specified in the `.edi` input file, the output file contains for each ED dataset

- * the RMSD of the fitted molecule to the reference structure (for atoms involved in fitting prior to calculating the ED constraints)
- * projections of the positions onto selected eigenvectors

FLOODING:

with `-flood`, you can specify which eigenvectors are used to compute a flooding potential, which will lead to extra forces expelling the structure out of the region described by the covariance matrix. If you switch `-restrain` the potential is inverted and the structure is kept in that region.

The origin is normally the average structure stored in the `eigvec.trr` file. It can be changed with `-ori` to an arbitrary position in configuration space. With `-tau`, `-deltaF0`, and `-Eflnull` you control the flooding behaviour. `Efl` is the flooding strength, it is updated according to the rule of adaptive flooding. `Tau` is the time constant of adaptive flooding, high τ means slow adaption (i.e. growth). `DeltaF0` is the flooding strength you want to reach after `tau` ps of simulation. To use constant `Efl` set `-tau` to zero.

`-alpha` is a fudge parameter to control the width of the flooding potential. A value of 2 has been found to give good results for most standard cases in flooding of proteins. α basically accounts for incomplete sampling, if you sampled further the width of the ensemble would increase, this is mimicked by $\alpha > 1$. For restraining, $\alpha < 1$ can give you smaller width in the restraining potential.

RESTART and FLOODING: If you want to restart a crashed flooding simulation please find the values `deltaF` and `Efl` in the output file and manually put them into the `.edi` file under `DELTA_F0` and `EFL_NULL`.

Files

<code>-f</code>	<code>eigvec.trr</code>	Input	Full precision trajectory: <code>trr trj cpt</code>
<code>-eig</code>	<code>eigenval.xvg</code>	Input, Opt.	<code>xvgr/xmgr</code> file
<code>-s</code>	<code>topol.tpr</code>	Input	Structure+mass(db): <code>tpr tpb tpa gro g96 pdb</code>
<code>-n</code>	<code>index.ndx</code>	Input, Opt.	Index file
<code>-tar</code>	<code>target.gro</code>	Input, Opt.	Structure file: <code>gro g96 pdb tpr etc.</code>
<code>-ori</code>	<code>origin.gro</code>	Input, Opt.	Structure file: <code>gro g96 pdb tpr etc.</code>
<code>-o</code>	<code>sam.edi</code>	Output	ED sampling input

Other options

<code>-h</code>	bool	no	Print help info and quit
<code>-version</code>	bool	no	Print version info and quit
<code>-nice</code>	int	0	Set the nicelevel
<code>-xvg</code>	enum	<code>xmgrace</code>	xvg plot formatting: <code>xmgrace</code> , <code>xmgr</code> or <code>none</code>
<code>-mon</code>	string		Indices of eigenvectors for projections of <code>x</code> (e.g. <code>1,2-5,9</code>) or <code>1-100:10</code> means <code>1 11 21 31 ... 91</code>
<code>-linfix</code>	string		Indices of eigenvectors for fixed increment linear sampling
<code>-linacc</code>	string		Indices of eigenvectors for acceptance linear sampling
<code>-radfix</code>	string		Indices of eigenvectors for fixed increment radius expansion
<code>-radacc</code>	string		Indices of eigenvectors for acceptance radius expansion
<code>-radcon</code>	string		Indices of eigenvectors for acceptance radius contraction
<code>-flood</code>	string		Indices of eigenvectors for flooding
<code>-outfrq</code>	int	100	Frequency (in steps) of writing output in <code>.xvg</code> file
<code>-slope</code>	real	0	Minimal slope in acceptance radius expansion
<code>-linstep</code>	string		Stepsizes (nm/step) for fixed increment linear sampling (put in quotes! "1.0 2.3 5.1 -3.1")

<code>-accdir</code>	string		Directions for acceptance linear sampling - only sign counts! (put in quotes! "-1 +1 -1.1")
<code>-radstep</code>	real	0	Stepsize (nm/step) for fixed increment radius expansion
<code>-maxedsteps</code>	int	0	Maximum number of steps per cycle
<code>-eqsteps</code>	int	0	Number of steps to run without any perturbations
<code>-deltaF0</code>	real	150	Target destabilization energy for flooding
<code>-deltaF</code>	real	0	Start deltaF with this parameter - default 0, nonzero values only needed for restart
<code>-tau</code>	real	0.1	Coupling constant for adaption of flooding strength according to deltaF0, 0 = infinity i.e. constant flooding strength
<code>-Eflnull</code>	real	0	The starting value of the flooding strength. The flooding strength is updated according to the adaptive flooding scheme. For a constant flooding strength use <code>-tau 0</code> .
<code>-T</code>	real	300	T is temperature, the value is needed if you want to do flooding
<code>-alpha</code>	real	1	Scale width of gaussian flooding potential with α^2
<code>-restrain</code>	bool	no	Use the flooding potential with inverted sign -> effects as quasiharmonic restraining potential
<code>-hessian</code>	bool	no	The eigenvectors and eigenvalues are from a Hessian matrix
<code>-harmonic</code>	bool	no	The eigenvalues are interpreted as spring constant
<code>-constF</code>	string		Constant force flooding: manually set the forces for the eigenvectors selected with <code>-flood</code> (put in quotes! "1.0 2.3 5.1 -3.1"). No other flooding parameters are needed when specifying the forces directly.

D.87 *make_ndx*

Index groups are necessary for almost every gromacs program. All these programs can generate default index groups. You **ONLY** have to use *make_ndx* when you need SPECIAL index groups. There is a default index group for the whole system, 9 default index groups for proteins, and a default index group is generated for every other residue name.

When no index file is supplied, also *make_ndx* will generate the default groups. With the index editor you can select on atom, residue and chain names and numbers. When a run input file is supplied you can also select on atom type. You can use NOT, AND and OR, you can split groups into chains, residues or atoms. You can delete and rename groups.

The atom numbering in the editor and the index file starts at 1.

Files

<code>-f</code>	<code>conf.gro</code>	Input, Opt.	Structure file: gro g96 pdb tpr etc.
<code>-n</code>	<code>index.ndx</code>	Input, Opt., Mandatory	Index file
<code>-o</code>	<code>index.ndx</code>	Output	Index file

Other options

<code>-h</code>	bool	no	Print help info and quit
<code>-version</code>	bool	no	Print version info and quit
<code>-nice</code>	int	0	Set the nicelevel
<code>-natoms</code>	int	0	set number of atoms (default: read from coordinate or index file)

D.88 *mdrun*

The *mdrun* program is the main computational chemistry engine within GROMACS. Obviously, it performs Molecular Dynamics simulations, but it can also perform Stochastic Dynamics, Energy Minimization, test particle insertion or (re)calculation of energies. Normal mode analysis is another option. In this

case `mdrun` builds a Hessian matrix from single conformation. For usual Normal Modes-like calculations, make sure that the structure provided is properly energy-minimized. The generated matrix can be diagonalized by `g_nmeig`.

The `mdrun` program reads the run input file (`-s`) and distributes the topology over nodes if needed. `mdrun` produces at least four output files. A single log file (`-g`) is written, unless the option `-seppot` is used, in which case each node writes a log file. The trajectory file (`-o`), contains coordinates, velocities and optionally forces. The structure file (`-c`) contains the coordinates and velocities of the last step. The energy file (`-e`) contains energies, the temperature, pressure, etc, a lot of these things are also printed in the log file. Optionally coordinates can be written to a compressed trajectory file (`-x`).

The option `-dhdl` is only used when free energy calculation is turned on.

A simulation can be run in parallel using two different parallelization schemes: MPI parallelization and/or OpenMP thread parallelization. The MPI parallelization uses multiple processes when `mdrun` is compiled with a normal MPI library or threads when `mdrun` is compiled with the GROMACS built-in thread-MPI library. OpenMP threads are supported when `mdrun` is compiled with OpenMP. Full OpenMP support is only available with the Verlet cut-off scheme, with the (older) group scheme only PME-only processes can use OpenMP parallelization. In all cases `mdrun` will by default try to use all the available hardware resources. With a normal MPI library only the options `-ntomp` (with the Verlet cut-off scheme) and `-ntomp_pme`, for PME-only processes, can be used to control the number of threads. With thread-MPI there are additional options `-nt`, which sets the total number of threads, and `-ntmpi`, which sets the number of thread-MPI threads. Note that using combined MPI+OpenMP parallelization is almost always slower than single parallelization, except at the scaling limit, where especially OpenMP parallelization of PME reduces the communication cost. OpenMP-only parallelization is much faster than MPI-only parallelization on a single CPU(-die). Since we currently don't have proper hardware topology detection, `mdrun` compiled with thread-MPI will only automatically use OpenMP-only parallelization when you use up to 4 threads, up to 12 threads with Intel Nehalem/Westmere, or up to 16 threads with Intel Sandy Bridge or newer CPUs. Otherwise MPI-only parallelization is used (except with GPUs, see below).

To quickly test the performance of the new Verlet cut-off scheme with old `.tpr` files, either on CPUs or CPUs+GPUs, you can use the `-testverlet` option. This should not be used for production, since it can slightly modify potentials and it will remove charge groups making analysis difficult, as the `.tpr` file will still contain charge groups. For production simulations it is highly recommended to specify `cutoff-scheme = Verlet` in the `.mdp` file.

With GPUs (only supported with the Verlet cut-off scheme), the number of GPUs should match the number of MPI processes or MPI threads, excluding PME-only processes/threads. With thread-MPI the number of MPI threads will automatically be set to the number of GPUs detected. When you want to use a subset of the available GPUs, you can use the `-gpu_id` option, where GPU id's are passed as a string, e.g. `02` for using GPUs 0 and 2. When you want different GPU id's on different nodes of a compute cluster, use the `GMX_GPU_ID` environment variable instead. The format for `GMX_GPU_ID` is identical to `-gpu_id`, but an environment variable can have different values on different nodes of a cluster.

When using PME with separate PME nodes or with a GPU, the two major compute tasks, the non-bonded force calculation and the PME calculation run on different compute resources. If this load is not balanced, some of the resources will be idle part of time. With the Verlet cut-off scheme this load is automatically balanced when the PME load is too high (but not when it is too low). This is done by scaling the Coulomb cut-off and PME grid spacing by the same amount. In the first few hundred steps different settings are tried and the fastest is chosen for the rest of the simulation. This does not affect the accuracy of the results, but it does affect the decomposition of the Coulomb energy into particle and mesh contributions. The auto-tuning can be turned off with the option `-notunepme`.

`mdrun pins` (sets affinity of) threads to specific cores, when all (logical) cores on a compute node are used by `mdrun`, even when no multi-threading is used, as this usually results in significantly better performance. If the queuing systems or the OpenMP library pinned threads, we honor this and don't pin again, even

though the layout may be sub-optimal. If you want to have `mdrun` override an already set thread affinity or pin threads when using less cores, use `-pin on`. With SMT (simultaneous multithreading), e.g. Intel Hyper-Threading, there are multiple logical cores per physical core. The option `-pinstride` sets the stride in logical cores for pinning consecutive threads. Without SMT, 1 is usually the best choice. With Intel Hyper-Threading 2 is best when using half or less of the logical cores, 1 otherwise. The default value of 0 do exactly that: it minimizes the threads per logical core, to optimize performance. If you want to run multiple `mdrun` jobs on the same physical node, you should set `-pinstride` to 1 when using all logical cores. When running multiple `mdrun` (or other) simulations on the same physical node, some simulations need to start pinning from a non-zero core to avoid overloading cores; with `-pinoffset` you can specify the offset in logical cores for pinning.

When `mdrun` is started using MPI with more than 1 process or with thread-MPI with more than 1 thread, MPI parallelization is used. By default domain decomposition is used, unless the `-pd` option is set, which selects particle decomposition.

With domain decomposition, the spatial decomposition can be set with option `-dd`. By default `mdrun` selects a good decomposition. The user only needs to change this when the system is very inhomogeneous. Dynamic load balancing is set with the option `-dlb`, which can give a significant performance improvement, especially for inhomogeneous systems. The only disadvantage of dynamic load balancing is that runs are no longer binary reproducible, but in most cases this is not important. By default the dynamic load balancing is automatically turned on when the measured performance loss due to load imbalance is 5% or more. At low parallelization these are the only important options for domain decomposition. At high parallelization the options in the next two sections could be important for increasing the performance.

When PME is used with domain decomposition, separate nodes can be assigned to do only the PME mesh calculation; this is computationally more efficient starting at about 12 nodes. The number of PME nodes is set with option `-npme`, this can not be more than half of the nodes. By default `mdrun` makes a guess for the number of PME nodes when the number of nodes is larger than 11 or performance wise not compatible with the PME grid x dimension. But the user should optimize `npme`. Performance statistics on this issue are written at the end of the log file. For good load balancing at high parallelization, the PME grid x and y dimensions should be divisible by the number of PME nodes (the simulation will run correctly also when this is not the case).

This section lists all options that affect the domain decomposition.

Option `-rdd` can be used to set the required maximum distance for inter charge-group bonded interactions. Communication for two-body bonded interactions below the non-bonded cut-off distance always comes for free with the non-bonded communication. Atoms beyond the non-bonded cut-off are only communicated when they have missing bonded interactions; this means that the extra cost is minor and nearly independent of the value of `-rdd`. With dynamic load balancing option `-rdd` also sets the lower limit for the domain decomposition cell sizes. By default `-rdd` is determined by `mdrun` based on the initial coordinates. The chosen value will be a balance between interaction range and communication cost.

When inter charge-group bonded interactions are beyond the bonded cut-off distance, `mdrun` terminates with an error message. For pair interactions and tabulated bonds that do not generate exclusions, this check can be turned off with the option `-noddcheck`.

When constraints are present, option `-rcon` influences the cell size limit as well. Atoms connected by NC constraints, where NC is the LINCS order plus 1, should not be beyond the smallest cell size. A error message is generated when this happens and the user should change the decomposition or decrease the LINCS order and increase the number of LINCS iterations. By default `mdrun` estimates the minimum cell size required for P-LINCS in a conservative fashion. For high parallelization it can be useful to set the distance required for P-LINCS with the option `-rcon`.

The `-dds` option sets the minimum allowed x, y and/or z scaling of the cells with dynamic load balancing. `mdrun` will ensure that the cells can scale down by at least this factor. This option is used for the automated spatial decomposition (when not using `-dd`) as well as for determining the number of grid pulses, which in

turn sets the minimum allowed cell size. Under certain circumstances the value of `-dds` might need to be adjusted to account for high or low spatial inhomogeneity of the system.

The option `-gcom` can be used to only do global communication every `n` steps. This can improve performance for highly parallel simulations where this global communication step becomes the bottleneck. For a global thermostat and/or barostat the temperature and/or pressure will also only be updated every `-gcom` steps. By default it is set to the minimum of `nstcalcenergy` and `nstlist`.

With `-rerun` an input trajectory can be given for which forces and energies will be (re)calculated. Neighbor searching will be performed for every frame, unless `nstlist` is zero (see the `.mdp` file).

ED (essential dynamics) sampling and/or additional flooding potentials are switched on by using the `-ei` flag followed by an `.edi` file. The `.edi` file can be produced with the `make_edi` tool or by using options in the `essdyn` menu of the WHAT IF program. `mdrun` produces a `.xvg` output file that contains projections of positions, velocities and forces onto selected eigenvectors.

When user-defined potential functions have been selected in the `.mdp` file the `-table` option is used to pass `mdrun` a formatted table with potential functions. The file is read from either the current directory or from the `GMXLIB` directory. A number of pre-formatted tables are presented in the `GMXLIB` dir, for 6-8, 6-9, 6-10, 6-11, 6-12 Lennard-Jones potentials with normal Coulomb. When pair interactions are present, a separate table for pair interaction functions is read using the `-tablep` option.

When tabulated bonded functions are present in the topology, interaction functions are read using the `-tableb` option. For each different tabulated interaction type the table file name is modified in a different way: before the file extension an underscore is appended, then a 'b' for bonds, an 'a' for angles or a 'd' for dihedrals and finally the table number of the interaction type.

The options `-px` and `-pf` are used for writing pull COM coordinates and forces when pulling is selected in the `.mdp` file.

With `-multi` or `-multidir`, multiple systems can be simulated in parallel. As many input files/directories are required as the number of systems. The `-multidir` option takes a list of directories (one for each system) and runs in each of them, using the input/output file names, such as specified by e.g. the `-s` option, relative to these directories. With `-multi`, the system number is appended to the run input and each output filename, for instance `topol.tpr` becomes `topol0.tpr`, `topol1.tpr` etc. The number of nodes per system is the total number of nodes divided by the number of systems. One use of this option is for NMR refinement: when distance or orientation restraints are present these can be ensemble averaged over all the systems.

With `-replex` replica exchange is attempted every given number of steps. The number of replicas is set with the `-multi` or `-multidir` option, described above. All run input files should use a different coupling temperature, the order of the files is not important. The random seed is set with `-reseed`. The velocities are scaled and neighbor searching is performed after every exchange.

Finally some experimental algorithms can be tested when the appropriate options have been given. Currently under investigation are: polarizability and X-ray bombardments.

The option `-membed` does what used to be `g_membed`, i.e. embed a protein into a membrane. The data file should contain the options that were passed to `g_membed` before. The `-mn` and `-mp` both apply to this as well.

The option `-pforce` is useful when you suspect a simulation crashes due to too large forces. With this option coordinates and forces of atoms with a force larger than a certain value will be printed to `stderr`.

Checkpoints containing the complete state of the system are written at regular intervals (option `-cpt`) to the file `-cpo`, unless option `-cpt` is set to -1. The previous checkpoint is backed up to `state_prev.cpt` to make sure that a recent state of the system is always available, even when the simulation is terminated while writing a checkpoint. With `-cpnum` all checkpoint files are kept and appended with the step number. A simulation can be continued by reading the full state from file with option `-cpi`. This option is intelligent

in the way that if no checkpoint file is found, Gromacs just assumes a normal run and starts from the first step of the `.tpr` file. By default the output will be appending to the existing output files. The checkpoint file contains checksums of all output files, such that you will never loose data when some output files are modified, corrupt or removed. There are three scenarios with `-cpi`:

- * no files with matching names are present: new output files are written
- * all files are present with names and checksums matching those stored in the checkpoint file: files are appended
- * otherwise no files are modified and a fatal error is generated

With `-noappend` new output files are opened and the simulation part number is added to all output file names. Note that in all cases the checkpoint file itself is not renamed and will be overwritten, unless its name does not match the `-cpi` option.

With checkpointing the output is appended to previously written output files, unless `-noappend` is used or none of the previous output files are present (except for the checkpoint file). The integrity of the files to be appended is verified using checksums which are stored in the checkpoint file. This ensures that output can not be mixed up or corrupted due to file appending. When only some of the previous output files are present, a fatal error is generated and no old output files are modified and no new output files are opened. The result with appending will be the same as from a single run. The contents will be binary identical, unless you use a different number of nodes or dynamic load balancing or the FFT library uses optimizations through timing.

With option `-maxh` a simulation is terminated and a checkpoint file is written at the first neighbor search step where the run time exceeds `-maxh*0.99` hours.

When `mdrun` receives a TERM signal, it will set `nsteps` to the current step plus one. When `mdrun` receives an INT signal (e.g. when `ctrl+C` is pressed), it will stop after the next neighbor search step (with `nstlist=0` at the next step). In both cases all the usual output will be written to file. When running with MPI, a signal to one of the `mdrun` processes is sufficient, this signal should not be sent to `mpirun` or the `mdrun` process that is the parent of the others.

When `mdrun` is started with MPI, it does not run `niced` by default.

Files

<code>-s</code>	<code>topol.tpr</code>	Input	Run input file: <code>tpr tpb tpa</code>
<code>-o</code>	<code>traj.trr</code>	Output	Full precision trajectory: <code>tr trj cpt</code>
<code>-x</code>	<code>traj.xtc</code>	Output, Opt.	Compressed trajectory (portable xdr format)
<code>-cpi</code>	<code>state.cpt</code>	Input, Opt.	Checkpoint file
<code>-cpi</code>	<code>state.cpt</code>	Output, Opt.	Checkpoint file
<code>-c</code>	<code>confout.gro</code>	Output	Structure file: <code>gro g96 pdb</code> etc.
<code>-e</code>	<code>ener.edr</code>	Output	Energy file
<code>-g</code>	<code>md.log</code>	Output	Log file
<code>-dhdl</code>	<code>dhdl.xvg</code>	Output, Opt.	<code>xvgr/xmgr</code> file
<code>-field</code>	<code>field.xvg</code>	Output, Opt.	<code>xvgr/xmgr</code> file
<code>-table</code>	<code>table.xvg</code>	Input, Opt.	<code>xvgr/xmgr</code> file
<code>-tabletf</code>	<code>tabletf.xvg</code>	Input, Opt.	<code>xvgr/xmgr</code> file
<code>-tablep</code>	<code>tablep.xvg</code>	Input, Opt.	<code>xvgr/xmgr</code> file
<code>-tableb</code>	<code>table.xvg</code>	Input, Opt.	<code>xvgr/xmgr</code> file
<code>-rerun</code>	<code>rerun.xtc</code>	Input, Opt.	Trajectory: <code>xtc trr trj gro g96 pdb cpt</code>
<code>-tpr</code>	<code>tpr.xvg</code>	Output, Opt.	<code>xvgr/xmgr</code> file
<code>-tpid</code>	<code>tpidist.xvg</code>	Output, Opt.	<code>xvgr/xmgr</code> file
<code>-ei</code>	<code>sam.edi</code>	Input, Opt.	ED sampling input
<code>-eo</code>	<code>edsam.xvg</code>	Output, Opt.	<code>xvgr/xmgr</code> file
<code>-j</code>	<code>wham.gct</code>	Input, Opt.	General coupling stuff
<code>-jo</code>	<code>bam.gct</code>	Output, Opt.	General coupling stuff

-ffout	gct.xvg	Output, Opt.	xvgr/xmgr file
-devout	deviatie.xvg	Output, Opt.	xvgr/xmgr file
-runav	runaver.xvg	Output, Opt.	xvgr/xmgr file
-px	pullx.xvg	Output, Opt.	xvgr/xmgr file
-pf	pullf.xvg	Output, Opt.	xvgr/xmgr file
-ro	rotation.xvg	Output, Opt.	xvgr/xmgr file
-ra	rotangles.log	Output, Opt.	Log file
-rs	rotslabs.log	Output, Opt.	Log file
-rt	rottorque.log	Output, Opt.	Log file
-mtx	nm.mtx	Output, Opt.	Hessian matrix
-dn	dipole.ndx	Output, Opt.	Index file
-multidir	rundir	Input, Opt., Mdrun	Run directory
-membed	membed.dat	Input, Opt.	Generic data file
-mp	membed.top	Input, Opt.	Topology file
-mn	membed.ndx	Input, Opt.	Index file

Other options

-h	bool	no	Print help info and quit
-version	bool	no	Print version info and quit
-nice	int	0	Set the nicelevel
-deffnm	string		Set the default filename for all file options
-xvg	enum	xmgrace	xvg plot formatting: xmgrace, xmgr or none
-pd	bool	no	Use particle decomposition
-dd	vector	0 0 0	Domain decomposition grid, 0 is optimize
-ddorder	enum		
		interleave	DD node order: interleave, pp_pme or cartesian
-npme	int	-1	Number of separate nodes to be used for PME, -1 is guess
-nt	int	0	Total number of threads to start (0 is guess)
-ntmpi	int	0	Number of thread-MPI threads to start (0 is guess)
-ntomp	int	0	Number of OpenMP threads per MPI process/thread to start (0 is guess)
-ntomp_pme	int	0	Number of OpenMP threads per MPI process/thread to start (0 is -ntomp)
-pin	enum	auto	Fix threads (or processes) to specific cores: auto, on or off
-pinoffset	int	0	The starting logical core number for pinning to cores; used to avoid pinning threads from different mdrun instances to the same core
-pinstride	int	0	Pinning distance in logical cores for threads, use 0 to minimize the number of threads per physical core
-gpu_id	string		List of GPU id's to use
-ddcheck	bool	yes	Check for all bonded interactions with DD
-rdd	real	0	The maximum distance for bonded interactions with DD (nm), 0 is determine from initial coordinates
-rcon	real	0	Maximum distance for P-LINCS (nm), 0 is estimate
-dlb	enum	auto	Dynamic load balancing (with DD): auto, no or yes
-dds	real	0.8	Minimum allowed dlb scaling of the DD cell size
-gcom	int	-1	Global communication frequency
-nb	enum	auto	Calculate non-bonded interactions on: auto, cpu, gpu or gpu_cpu
-tunepme	bool	yes	Optimize PME load between PP/PME nodes or GPU/CPU
-testverlet	bool	no	Test the Verlet non-bonded scheme
-v	bool	no	Be loud and noisy
-compact	bool	yes	Write a compact log file
-seppot	bool	no	Write separate V and dVdl terms for each interaction type and node to the log file(s)
-pforce	real	-1	Print all forces larger than this (kJ/mol nm)
-reprod	bool	no	Try to avoid optimizations that affect binary reproducibility

-cpt	real	15	Checkpoint interval (minutes)
-cpnum	bool	no	Keep and number checkpoint files
-append	bool	yes	Append to previous output files when continuing from checkpoint instead of adding the simulation part number to all file names
-nsteps	step	-2	Run this number of steps, overrides .mdp file option
-maxh	real	-1	Terminate after 0.99 times this time (hours)
-multi	int	0	Do multiple simulations in parallel
-replex	int	0	Attempt replica exchange periodically with this period (steps)
-nex	int	0	Number of random exchanges to carry out each exchange interval (N^3 is one suggestion). -nex zero or not specified gives neighbor replica exchange.
-reseed	int	-1	Seed for replica exchange, -1 is generate a seed
-ionize	bool	no	Do a simulation including the effect of an X-Ray bombardment on your system

D.89 *mk_angndx*

mk_angndx makes an index file for calculation of angle distributions etc. It uses a run input file (*.tpr*) for the definitions of the angles, dihedrals etc.

Files

-s	<i>topol.tpr</i>	Input	Run input file: <i>tpr tpb tpa</i>
-n	<i>angle.ndx</i>	Output	Index file

Other options

-h	bool	no	Print help info and quit
-version	bool	no	Print version info and quit
-nice	int	0	Set the nicelevel
-type	enum	angle	Type of angle: angle, dihedral, improper or ryckaert-bellemans
-hyd	bool	yes	Include angles with atoms with mass < 1.5
-hq	real	-1	Ignore angles with atoms with mass < 1.5 and magnitude of their charge less than this value

D.90 *ngmx*

ngmx is the GROMACS trajectory viewer. This program reads a trajectory file, a run input file and an index file and plots a 3D structure of your molecule on your standard X Window screen. No need for a high end graphics workstation, it even works on Monochrome screens.

The following features have been implemented: 3D view, rotation, translation and scaling of your molecule(s), labels on atoms, animation of trajectories, hardcopy in PostScript format, user defined atom-filters runs on MIT-X (real X), open windows and motif, user friendly menus, option to remove periodicity, option to show computational box.

Some of the more common X command line options can be used: *-bg*, *-fg* change colors, *-font fontname* changes the font.

Files

-f	<i>traj.xtc</i>	Input	Trajectory: <i>xtc trr trj gro g96 pdb cpt</i>
-s	<i>topol.tpr</i>	Input	Run input file: <i>tpr tpb tpa</i>
-n	<i>index.ndx</i>	Input, Opt.	Index file

Other options

-h	bool	no	Print help info and quit
-version	bool	no	Print version info and quit
-nice	int	0	Set the nicelevel
-b	time	0	First frame (ps) to read from trajectory
-e	time	0	Last frame (ps) to read from trajectory
-dt	time	0	Only use frame when t MOD dt = first time (ps)

- Balls option does not work
- Some times dumps core without a good reason

D.91 pdb2gmx

This program reads a `.pdb` (or `.gro`) file, reads some database files, adds hydrogens to the molecules and generates coordinates in GROMACS (GROMOS), or optionally `.pdb`, format and a topology in GROMACS format. These files can subsequently be processed to generate a run input file.

`pdb2gmx` will search for force fields by looking for a `forcefield.itp` file in subdirectories `<forcefield>.ff` of the current working directory and of the GROMACS library directory as inferred from the path of the binary or the `GMXLIB` environment variable. By default the forcefield selection is interactive, but you can use the `-ff` option to specify one of the short names in the list on the command line instead. In that case `pdb2gmx` just looks for the corresponding `<forcefield>.ff` directory.

After choosing a force field, all files will be read only from the corresponding force field directory. If you want to modify or add a residue types, you can copy the force field directory from the GROMACS library directory to your current working directory. If you want to add new protein residue types, you will need to modify `residuetypes.dat` in the library directory or copy the whole library directory to a local directory and set the environment variable `GMXLIB` to the name of that directory. Check Chapter 5 of the manual for more information about file formats.

Note that a `.pdb` file is nothing more than a file format, and it need not necessarily contain a protein structure. Every kind of molecule for which there is support in the database can be converted. If there is no support in the database, you can add it yourself.

The program has limited intelligence, it reads a number of database files, that allow it to make special bonds (Cys-Cys, Heme-His, etc.), if necessary this can be done manually. The program can prompt the user to select which kind of LYS, ASP, GLU, CYS or HIS residue is desired. For Lys the choice is between neutral (two protons on NZ) or protonated (three protons, default), for Asp and Glu unprotonated (default) or protonated, for His the proton can be either on ND1, on NE2 or on both. By default these selections are done automatically. For His, this is based on an optimal hydrogen bonding conformation. Hydrogen bonds are defined based on a simple geometric criterion, specified by the maximum hydrogen-donor-acceptor angle and donor-acceptor distance, which are set by `-angle` and `-dist` respectively.

The protonation state of N- and C-termini can be chosen interactively with the `-ter` flag. Default termini are ionized (NH₃⁺ and COO⁻), respectively. Some force fields support zwitterionic forms for chains of one residue, but for polypeptides these options should NOT be selected. The AMBER force fields have unique forms for the terminal residues, and these are incompatible with the `-ter` mechanism. You need to prefix your N- or C-terminal residue names with "N" or "C" respectively to use these forms, making sure you preserve the format of the coordinate file. Alternatively, use named terminating residues (e.g. ACE, NME).

The separation of chains is not entirely trivial since the markup in user-generated PDB files frequently varies and sometimes it is desirable to merge entries across a TER record, for instance if you want a disulfide bridge or distance restraints between two protein chains or if you have a HEME group bound to a protein.

In such cases multiple chains should be contained in a single `moleculetype` definition. To handle this, `pdb2gmx` uses two separate options. First, `-chainsep` allows you to choose when a new chemical chain should start, and termini added when applicable. This can be done based on the existence of TER records, when the chain id changes, or combinations of either or both of these. You can also do the selection fully interactively. In addition, there is a `-merge` option that controls how multiple chains are merged into one `moleculetype`, after adding all the chemical termini (or not). This can be turned off (no merging), all non-water chains can be merged into a single molecule, or the selection can be done interactively.

`pdb2gmx` will also check the occupancy field of the `.pdb` file. If any of the occupancies are not one, indicating that the atom is not resolved well in the structure, a warning message is issued. When a `.pdb` file does not originate from an X-ray structure determination all occupancy fields may be zero. Either way, it is up to the user to verify the correctness of the input data (read the article!).

During processing the atoms will be reordered according to GROMACS conventions. With `-n` an index file can be generated that contains one group reordered in the same way. This allows you to convert a GROMOS trajectory and coordinate file to GROMOS. There is one limitation: reordering is done after the hydrogens are stripped from the input and before new hydrogens are added. This means that you should not use `-ignh`.

The `.gro` and `.g96` file formats do not support chain identifiers. Therefore it is useful to enter a `.pdb` file name at the `-o` option when you want to convert a multi-chain `.pdb` file.

The option `-vsite` removes hydrogen and fast improper dihedral motions. Angular and out-of-plane motions can be removed by changing hydrogens into virtual sites and fixing angles, which fixes their position relative to neighboring atoms. Additionally, all atoms in the aromatic rings of the standard amino acids (i.e. PHE, TRP, TYR and HIS) can be converted into virtual sites, eliminating the fast improper dihedral fluctuations in these rings. **Note** that in this case all other hydrogen atoms are also converted to virtual sites. The mass of all atoms that are converted into virtual sites, is added to the heavy atoms.

Also slowing down of dihedral motion can be done with `-heavyh` done by increasing the hydrogen-mass by a factor of 4. This is also done for water hydrogens to slow down the rotational motion of water. The increase in mass of the hydrogens is subtracted from the bonded (heavy) atom so that the total mass of the system remains the same.

Files

<code>-f</code>	<code>eiwit.pdb</code>	Input	Structure file: <code>gro g96 pdb tpr</code> etc.
<code>-o</code>	<code>conf.gro</code>	Output	Structure file: <code>gro g96 pdb</code> etc.
<code>-p</code>	<code>topol.top</code>	Output	Topology file
<code>-i</code>	<code>posre.itp</code>	Output	Include file for topology
<code>-n</code>	<code>clean.ndx</code>	Output, Opt.	Index file
<code>-q</code>	<code>clean.pdb</code>	Output, Opt.	Structure file: <code>gro g96 pdb</code> etc.

Other options

<code>-h</code>	bool	no	Print help info and quit
<code>-version</code>	bool	no	Print version info and quit
<code>-nice</code>	int	0	Set the nicelevel
<code>-chainsep</code>	enum		
	<code>id_or_ter</code>		Condition in PDB files when a new chain should be started (adding termini): <code>id_or_ter</code> , <code>id_and_ter</code> , <code>ter</code> , <code>id</code> or <code>interactive</code>
<code>-merge</code>	enum	no	Merge multiple chains into a single [moleculetype]: <code>no</code> , <code>all</code> or <code>interactive</code>
<code>-ff</code>	string	select	Force field, interactive by default. Use <code>-h</code> for information.
<code>-water</code>	enum	select	Water model to use: <code>select</code> , <code>none</code> , <code>spc</code> , <code>spce</code> , <code>tip3p</code> , <code>tip4p</code> or <code>tip5p</code>
<code>-inter</code>	bool	no	Set the next 8 options to interactive
<code>-ss</code>	bool	no	Interactive SS bridge selection
<code>-ter</code>	bool	no	Interactive termini selection, instead of charged (default)

-lys	bool	no	Interactive lysine selection, instead of charged
-arg	bool	no	Interactive arginine selection, instead of charged
-asp	bool	no	Interactive aspartic acid selection, instead of charged
-glu	bool	no	Interactive glutamic acid selection, instead of charged
-gln	bool	no	Interactive glutamine selection, instead of neutral
-his	bool	no	Interactive histidine selection, instead of checking H-bonds
-angle	real	135	Minimum hydrogen-donor-acceptor angle for a H-bond (degrees)
-dist	real	0.3	Maximum donor-acceptor distance for a H-bond (nm)
-una	bool	no	Select aromatic rings with united CH atoms on phenylalanine, tryptophane and tyrosine
-ignh	bool	no	Ignore hydrogen atoms that are in the coordinate file
-missing	bool	no	Continue when atoms are missing, dangerous
-v	bool	no	Be slightly more verbose in messages
-posrefc	real	1000	Force constant for position restraints
-vsite	enum	none	Convert atoms to virtual sites: none, hydrogens or aromatics
-heavyh	bool	no	Make hydrogen atoms heavy
-deuterate	bool	no	Change the mass of hydrogens to 2 amu
-chargegrp	bool	yes	Use charge groups in the .rtp file
-cmap	bool	yes	Use cmap torsions (if enabled in the .rtp file)
-renum	bool	no	Renumber the residues consecutively in the output
-rtpres	bool	no	Use .rtp entry names as residue names

D.92 tpbconv

tpbconv can edit run input files in four ways.

1. by modifying the number of steps in a run input file with options `-extend`, `-until` or `-nsteps` (`nsteps=-1` means unlimited number of steps)
2. (OBSOLETE) by creating a run input file for a continuation run when your simulation has crashed due to e.g. a full disk, or by making a continuation run input file. This option is obsolete, since `mdrun` now writes and reads checkpoint files. **Note** that a frame with coordinates and velocities is needed. When pressure and/or Nose-Hoover temperature coupling is used an energy file can be supplied to get an exact continuation of the original run.
3. by creating a `.tpx` file for a subset of your original `tpx` file, which is useful when you want to remove the solvent from your `.tpx` file, or when you want to make e.g. a pure $C\alpha$ `.tpx` file. Note that you may need to use `-nsteps -1` (or similar) to get this to work. **WARNING: this .tpx file is not fully functional.**
4. by setting the charges of a specified group to zero. This is useful when doing free energy estimates using the LIE (Linear Interaction Energy) method.

Files

-s	topol.tpr	Input	Run input file: tpr tpb tpa
-f	traj.trr	Input, Opt.	Full precision trajectory: trr trj cpt
-e	ener.edr	Input, Opt.	Energy file
-n	index.ndx	Input, Opt.	Index file
-o	tpxout.tpr	Output	Run input file: tpr tpb tpa

Other options

-h	bool	no	Print help info and quit
-version	bool	no	Print version info and quit
-nice	int	0	Set the nicelevel
-extend	real	0	Extend runtime by this amount (ps)

<code>-until</code>	real	0	Extend runtime until this ending time (ps)
<code>-nsteps</code>	int	0	Change the number of steps
<code>-time</code>	real	-1	Continue from frame at this time (ps) instead of the last frame
<code>-zeroq</code>	bool	no	Set the charges of a group (from the index) to zero
<code>-vel</code>	bool	yes	Require velocities from trajectory
<code>-cont</code>	bool	yes	For exact continuation, the constraints should not be applied before the first step
<code>-init_fep_state</code>	int	0	fep state to initialize from

D.93 *trjcat*

trjcat concatenates several input trajectory files in sorted order. In case of double time frames the one in the later file is used. By specifying `-settime` you will be asked for the start time of each file. The input files are taken from the command line, such that a command like `trjcat -f *.trr -o fixed.trr` should do the trick. Using `-cat`, you can simply paste several files together without removal of frames with identical time stamps.

One important option is inferred when the output file is amongst the input files. In that case that particular file will be appended to which implies you do not need to store double the amount of data. Obviously the file to append to has to be the one with lowest starting time since one can only append at the end of a file.

If the `-demux` option is given, the N trajectories that are read, are written in another order as specified in the `.xvg` file. The `.xvg` file should contain something like:

```
0 0 1 2 3 4 5
2 1 0 2 3 5 4
```

Where the first number is the time, and subsequent numbers point to trajectory indices. The frames corresponding to the numbers present at the first line are collected into the output trajectory. If the number of frames in the trajectory does not match that in the `.xvg` file then the program tries to be smart. Beware.

Files

<code>-f</code>	<code>traj.xtc</code>	Input, Mult.	Trajectory: xtc trr trj gro g96 pdb cpt
<code>-o</code>	<code>trajout.xtc</code>	Output, Mult.	Trajectory: xtc trr trj gro g96 pdb
<code>-n</code>	<code>index.ndx</code>	Input, Opt.	Index file
<code>-demux</code>	<code>remd.xvg</code>	Input, Opt.	xvgr/xmgr file

Other options

<code>-h</code>	bool	no	Print help info and quit
<code>-version</code>	bool	no	Print version info and quit
<code>-nice</code>	int	19	Set the nicelevel
<code>-tu</code>	enum	ps	Time unit: fs, ps, ns, us, ms or s
<code>-xvg</code>	enum	xmgrace	xvg plot formatting: xmgrace, xmgr or none
<code>-b</code>	time	-1	First time to use (ps)
<code>-e</code>	time	-1	Last time to use (ps)
<code>-dt</code>	time	0	Only write frame when $t \text{ MOD } dt = \text{first time (ps)}$
<code>-prec</code>	int	3	Precision for <code>.xtc</code> and <code>.gro</code> writing in number of decimal places
<code>-vel</code>	bool	yes	Read and write velocities if possible
<code>-settime</code>	bool	no	Change starting time interactively
<code>-sort</code>	bool	yes	Sort trajectory files (not frames)
<code>-keeplast</code>	bool	no	Keep overlapping frames at end of trajectory
<code>-overwrite</code>	bool	no	Overwrite overlapping frames during appending
<code>-cat</code>	bool	no	Do not discard double time frames

D.94 trjconv

`trjconv` can convert trajectory files in many ways:

1. from one format to another
2. select a subset of atoms
3. change the periodicity representation
4. keep multimeric molecules together
5. center atoms in the box
6. fit atoms to reference structure
7. reduce the number of frames
8. change the timestamps of the frames (`-t0` and `-timestep`)
9. cut the trajectory in small subtrajectories according to information in an index file. This allows subsequent analysis of the subtrajectories that could, for example, be the result of a cluster analysis. Use option `-sub`. This assumes that the entries in the index file are frame numbers and dumps each group in the index file to a separate trajectory file.
10. select frames within a certain range of a quantity given in an `.xvg` file.

The program `trjcat` is better suited for concatenating multiple trajectory files.

Currently seven formats are supported for input and output: `.xtc`, `.trr`, `.trj`, `.gro`, `.g96`, `.pdb` and `.g87`. The file formats are detected from the file extension. The precision of `.xtc` and `.gro` output is taken from the input file for `.xtc`, `.gro` and `.pdb`, and from the `-ndec` option for other input formats. The precision is always taken from `-ndec`, when this option is set. All other formats have fixed precision. `.trr` and `.trj` output can be single or double precision, depending on the precision of the `trjconv` binary. Note that velocities are only supported in `.trr`, `.trj`, `.gro` and `.g96` files.

Option `-app` can be used to append output to an existing trajectory file. No checks are performed to ensure integrity of the resulting combined trajectory file.

Option `-sep` can be used to write every frame to a separate `.gro`, `.g96` or `.pdb` file. By default, all frames are written to one file. `.pdb` files with all frames concatenated can be viewed with `rasmol -nmrpdb`.

It is possible to select part of your trajectory and write it out to a new trajectory file in order to save disk space, e.g. for leaving out the water from a trajectory of a protein in water. **ALWAYS** put the original trajectory on tape! We recommend to use the portable `.xtc` format for your analysis to save disk space and to have portable files.

There are two options for fitting the trajectory to a reference either for essential dynamics analysis, etc. The first option is just plain fitting to a reference structure in the structure file. The second option is a progressive fit in which the first timeframe is fitted to the reference structure in the structure file to obtain and each subsequent timeframe is fitted to the previously fitted structure. This way a continuous trajectory is generated, which might not be the case when using the regular fit method, e.g. when your protein undergoes large conformational transitions.

Option `-pbc` sets the type of periodic boundary condition treatment:

- * `mol` puts the center of mass of molecules in the box, and requires a run input file to be supplied with `-s`.
- * `res` puts the center of mass of residues in the box.
- * `atom` puts all the atoms in the box.
- * `nojump` checks if atoms jump across the box and then puts them back. This has the effect that all molecules will remain whole (provided they were whole in the initial conformation). **Note** that this ensures a continuous trajectory but molecules may diffuse out of the box. The starting configuration for this procedure is taken from the structure file, if one is supplied, otherwise it is the first frame.
- * `cluster` clusters all the atoms in the selected index such that they are all closest to the center of mass of the cluster, which is iteratively updated. **Note** that this will only give meaningful results if you in fact have a cluster. Luckily that can be checked afterwards using a trajectory viewer. Note also that if your

molecules are broken this will not work either.

The separate option `-clustercenter` can be used to specify an approximate center for the cluster. This is useful e.g. if you have two big vesicles, and you want to maintain their relative positions.

* `whole` only makes broken molecules whole.

Option `-ur` sets the unit cell representation for options `mol`, `res` and `atom` of `-pbc`. All three options give different results for triclinic boxes and identical results for rectangular boxes. `rect` is the ordinary brick shape. `tric` is the triclinic unit cell. `compact` puts all atoms at the closest distance from the center of the box. This can be useful for visualizing e.g. truncated octahedra or rhombic dodecahedra. The center for options `tric` and `compact` is `tric` (see below), unless the option `-boxcenter` is set differently.

Option `-center` centers the system in the box. The user can select the group which is used to determine the geometrical center. Option `-boxcenter` sets the location of the center of the box for options `-pbc` and `-center`. The center options are: `tric`: half of the sum of the box vectors, `rect`: half of the box diagonal, `zero`: zero. Use option `-pbc mol` in addition to `-center` when you want all molecules in the box after the centering.

It is not always possible to use combinations of `-pbc`, `-fit`, `-ur` and `-center` to do exactly what you want in one call to `trjconv`. Consider using multiple calls, and check out the GROMACS website for suggestions.

With `-dt`, it is possible to reduce the number of frames in the output. This option relies on the accuracy of the times in your input trajectory, so if these are inaccurate use the `-timestep` option to modify the time (this can be done simultaneously). For making smooth movies, the program `g_filter` can reduce the number of frames while using low-pass frequency filtering, this reduces aliasing of high frequency motions.

Using `-trunc trjconv` can truncate `.trj` in place, i.e. without copying the file. This is useful when a run has crashed during disk I/O (i.e. full disk), or when two contiguous trajectories must be concatenated without having double frames.

Option `-dump` can be used to extract a frame at or near one specific time from your trajectory.

Option `-drop` reads an `.xvg` file with times and values. When options `-dropunder` and/or `-dropover` are set, frames with a value below and above the value of the respective options will not be written.

Files

<code>-f</code>	<code>traj.xtc</code>	Input	Trajectory: xtc trr trj gro g96 pdb cpt
<code>-o</code>	<code>trajout.xtc</code>	Output	Trajectory: xtc trr trj gro g96 pdb
<code>-s</code>	<code>topol.tpr</code>	Input, Opt.	Structure+mass(db): tpr tpb tpa gro g96 pdb
<code>-n</code>	<code>index.ndx</code>	Input, Opt.	Index file
<code>-fr</code>	<code>frames.ndx</code>	Input, Opt.	Index file
<code>-sub</code>	<code>cluster.ndx</code>	Input, Opt.	Index file
<code>-drop</code>	<code>drop.xvg</code>	Input, Opt.	xvgr/xmgr file

Other options

<code>-h</code>	bool	no	Print help info and quit
<code>-version</code>	bool	no	Print version info and quit
<code>-nice</code>	int	19	Set the nicelevel
<code>-b</code>	time	0	First frame (ps) to read from trajectory
<code>-e</code>	time	0	Last frame (ps) to read from trajectory
<code>-tu</code>	enum	ps	Time unit: fs, ps, ns, us, ms or s
<code>-w</code>	bool	no	View output <code>.xvg</code> , <code>.xpm</code> , <code>.eps</code> and <code>.pdb</code> files
<code>-xvg</code>	enum	xmgrace	xvg plot formatting: xmgrace, xmgr or none
<code>-skip</code>	int	1	Only write every nr-th frame
<code>-dt</code>	time	0	Only write frame when $t \text{ MOD } dt = \text{first time (ps)}$
<code>-round</code>	bool	no	Round measurements to nearest picosecond

-dump	time	-1	Dump frame nearest specified time (ps)
-t0	time	0	Starting time (ps) (default: don't change)
-timestep	time	0	Change time step between input frames (ps)
-pbc	enum	none	PBC treatment (see help text for full description): none, mol, res, atom, nojump, cluster or whole
-ur	enum	rect	Unit-cell representation: rect, tric or compact
-center	bool	no	Center atoms in box
-boxcenter	enum	tric	Center for -pbc and -center: tric, rect or zero
-box	vector	0 0 0	Size for new cubic box (default: read from input)
-clustercenter	vector	0 0 0	Optional starting point for pbc cluster option
-trans	vector	0 0 0	All coordinates will be translated by trans. This can advantageously be combined with -pbc mol -ur compact.
-shift	vector	0 0 0	All coordinates will be shifted by frametr*shift
-fit	enum	none	Fit molecule to ref structure in the structure file: none, rot+trans, rotxy+transxy, translation, transxy or progressive
-ndec	int	3	Precision for .xtc and .gro writing in number of decimal places
-vel	bool	yes	Read and write velocities if possible
-force	bool	no	Read and write forces if possible
-trunc	time	-1	Truncate input trajectory file after this time (ps)
-exec	string		Execute command for every output frame with the frame number as argument
-app	bool	no	Append output
-split	time	0	Start writing new file when t MOD split = first time (ps)
-sep	bool	no	Write each frame to a separate .gro, .g96 or .pdb file
-nzero	int	0	If the -sep flag is set, use these many digits for the file numbers and prepend zeros as needed
-dropunder	real	0	Drop all frames below this value
-dropover	real	0	Drop all frames above this value
-conect	bool	no	Add conect records when writing .pdb files. Useful for visualization of non-standard molecules, e.g. coarse grained ones

D.95 trjorder

`trjorder` orders molecules according to the smallest distance to atoms in a reference group or on z-coordinate (with option `-z`). With distance ordering, it will ask for a group of reference atoms and a group of molecules. For each frame of the trajectory the selected molecules will be reordered according to the shortest distance between atom number `-da` in the molecule and all the atoms in the reference group. The center of mass of the molecules can be used instead of a reference atom by setting `-da` to 0. All atoms in the trajectory are written to the output trajectory.

`trjorder` can be useful for e.g. analyzing the `n` waters closest to a protein. In that case the reference group would be the protein and the group of molecules would consist of all the water atoms. When an index group of the first `n` waters is made, the ordered trajectory can be used with any Gromacs program to analyze the `n` closest waters.

If the output file is a `.pdb` file, the distance to the reference target will be stored in the B-factor field in order to color with e.g. Rasmol.

With option `-nshell` the number of molecules within a shell of radius `-r` around the reference group are printed.

Files

-f	traj.xtc	Input	Trajectory: xtc trr trj gro g96 pdb cpt
-s	topol.tpr	Input	Structure+mass(db): tpr tpb tpa gro g96 pdb

-n	index.ndx	Input, Opt.	Index file
-o	ordered.xtc	Output, Opt.	Trajectory: xtc trr trj gro g96 pdb
-nshell	nshell.xvg	Output, Opt.	xvgr/xmgr file

Other options

-h	bool	no	Print help info and quit
-version	bool	no	Print version info and quit
-nice	int	19	Set the nicelevel
-b	time	0	First frame (ps) to read from trajectory
-e	time	0	Last frame (ps) to read from trajectory
-dt	time	0	Only use frame when $t \text{ MOD } dt = \text{first time (ps)}$
-xvg	enum xmgrace		xvg plot formatting: xmgrace, xmgr or none
-na	int	3	Number of atoms in a molecule
-da	int	1	Atom used for the distance calculation, 0 is COM
-com	bool	no	Use the distance to the center of mass of the reference group
-r	real	0	Cutoff used for the distance calculation when computing the number of molecules in a shell around e.g. a protein
-z	bool	no	Order molecules on z-coordinate

D.96 xpm2ps

xpm2ps makes a beautiful color plot of an XPixelMap file. Labels and axis can be displayed, when they are supplied in the correct matrix format. Matrix data may be generated by programs such as do_dssp, g_rms or g_mdmat.

Parameters are set in the .m2p file optionally supplied with -di. Reasonable defaults are provided. Settings for the y-axis default to those for the x-axis. Font names have a defaulting hierarchy: titlefont -> legendfont; titlefont -> (xfont -> yfont -> ytickfont) -> xtickfont, e.g. setting titlefont sets all fonts, setting xfont sets yfont, ytickfont and xtickfont.

When no .m2p file is supplied, many settings are taken from command line options. The most important option is -size, which sets the size of the whole matrix in postscript units. This option can be overridden with the -bx and -by options (and the corresponding parameters in the .m2p file), which set the size of a single matrix element.

With -f2 a second matrix file can be supplied. Both matrix files will be read simultaneously and the upper left half of the first one (-f) is plotted together with the lower right half of the second one (-f2). The diagonal will contain values from the matrix file selected with -diag. Plotting of the diagonal values can be suppressed altogether by setting -diag to none. In this case, a new color map will be generated with a red gradient for negative numbers and a blue for positive. If the color coding and legend labels of both matrices are identical, only one legend will be displayed, else two separate legends are displayed. With -combine, an alternative operation can be selected to combine the matrices. The output range is automatically set to the actual range of the combined matrix. This can be overridden with -cmin and -cmax.

-title can be set to none to suppress the title, or to ylabel to show the title in the Y-label position (alongside the y-axis).

With the -rainbow option, dull grayscale matrices can be turned into attractive color pictures.

Merged or rainbowed matrices can be written to an XPixelMap file with the -xpm option.

Files

-f	root.xpm	Input	X PixMap compatible matrix file
-f2	root2.xpm	Input, Opt.	X PixMap compatible matrix file

-di	ps.m2p	Input, Opt., List	Input file for mat2ps
-do	out.m2p	Output, Opt.	Input file for mat2ps
-o	plot.eps	Output, Opt.	Encapsulated PostScript (tm) file
-xpm	root.xpm	Output, Opt.	X PixMap compatible matrix file

Other options

-h	bool	no	Print help info and quit
-version	bool	no	Print version info and quit
-nice	int	0	Set the nicelevel
-w	bool	no	View output .xvg, .xpm, .eps and .pdb files
-frame	bool	yes	Display frame, ticks, labels, title and legend
-title	enum	top	Show title at: top, once, ylabel or none
-yonce	bool	no	Show y-label only once
-legend	enum	both	Show legend: both, first, second or none
-diag	enum	first	Diagonal: first, second or none
-size	real	400	Horizontal size of the matrix in ps units
-bx	real	0	Element x-size, overrides -size (also y-size when -by is not set)
-by	real	0	Element y-size
-rainbow	enum	no	Rainbow colors, convert white to: no, blue or red
-gradient	vector	0 0 0	Re-scale colormap to a smooth gradient from white 1,1,1 to r,g,b
-skip	int	1	only write out every nr-th row and column
-zeroline	bool	no	insert line in .xpm matrix where axis label is zero
-legoffset	int	0	Skip first N colors from .xpm file for the legend
-combine	enum	halves	Combine two matrices: halves, add, sub, mult or div
-cmin	real	0	Minimum for combination output
-cmax	real	0	Maximum for combination output

Bibliography

- [1] Bekker, H., Berendsen, H. J. C., Dijkstra, E. J., Achterop, S., van Drunen, R., van der Spoel, D., Sijbers, A., Keegstra, H., Reitsma, B., Renardus, M. K. R. Gromacs: A parallel computer for molecular dynamics simulations. In *Physics Computing 92* (Singapore, 1993). de Groot, R. A., Nadrchal, J., eds. . World Scientific.
- [2] Berendsen, H. J. C., van der Spoel, D., van Drunen, R. GROMACS: A message-passing parallel molecular dynamics implementation. *Comp. Phys. Comm.* 91:43–56, 1995.
- [3] Lindahl, E., Hess, B., van der Spoel, D. GROMACS 3.0: A package for molecular simulation and trajectory analysis. *J. Mol. Mod.* 7:306–317, 2001.
- [4] van der Spoel, D., Lindahl, E., Hess, B., Groenhof, G., Mark, A. E., Berendsen, H. J. C. GROMACS: Fast, Flexible and Free. *J. Comp. Chem.* 26:1701–1718, 2005.
- [5] Hess, B., Kutzner, C., van der Spoel, D., Lindahl, E. GROMACS 4: Algorithms for Highly Efficient, Load-Balanced, and Scalable Molecular Simulation. *J. Chem. Theory Comp.* 4(3):435–447, 2008.
- [6] Pronk, S., Páll, S., Schulz, R., Larsson, P., Bjelkmar, P., Apostolov, R., Shirts, M. R., Smith, J. C., Kasson, P. M., van der Spoel, D., Hess, B., Lindahl, E. Gromacs 4.5: a high-throughput and highly parallel open source molecular simulation toolkit. *Bioinformatics* 29(7):845–854, 2013.
- [7] van Gunsteren, W. F., Berendsen, H. J. C. Computer simulation of molecular dynamics: Methodology, applications, and perspectives in chemistry. *Angew. Chem. Int. Ed. Engl.* 29:992–1023, 1990.
- [8] Fraaije, J. G. E. M. Dynamic density functional theory for microphase separation kinetics of block copolymer melts. *J. Chem. Phys.* 99:9202–9212, 1993.
- [9] McQuarrie, D. A. *Statistical Mechanics*. New York: Harper & Row. 1976.
- [10] van Gunsteren, W. F., Berendsen, H. J. C. Algorithms for macromolecular dynamics and constraint dynamics. *Mol. Phys.* 34:1311–1327, 1977.
- [11] van Gunsteren, W. F., Karplus, M. Effect of constraints on the dynamics of macromolecules. *Macromolecules* 15:1528–1544, 1982.

- [12] Darden, T., York, D., Pedersen, L. Particle mesh Ewald: An $N \log(N)$ method for Ewald sums in large systems. *J. Chem. Phys.* 98:10089–10092, 1993.
- [13] Essmann, U., Perera, L., Berkowitz, M. L., Darden, T., Lee, H., Pedersen, L. G. A smooth particle mesh ewald potential. *J. Chem. Phys.* 103:8577–8592, 1995.
- [14] Geman, S., Geman, D. Stochastic relaxation, Gibbs distributions and the Bayesian restoration of images. *IEEE Trans. Patt. Anal. Mach. Int.* 6:721, 1984.
- [15] Nilges, M., Clore, G. M., Gronenborn, A. M. Determination of three-dimensional structures of proteins from interproton distance data by dynamical simulated annealing from a random array of atoms. *FEBS Lett.* 239:129–136, 1988.
- [16] van Schaik, R. C., Berendsen, H. J. C., Torda, A. E., van Gunsteren, W. F. A structure refinement method based on molecular dynamics in 4 spatial dimensions. *J. Mol. Biol.* 234:751–762, 1993.
- [17] Zimmerman, K. All purpose molecular mechanics simulator and energy minimizer. *J. Comp. Chem.* 12:310–319, 1991.
- [18] Adams, D. J., Adams, E. M., Hills, G. J. The computer simulation of polar liquids. *Mol. Phys.* 38:387–400, 1979.
- [19] Bekker, H., Dijkstra, E. J., Renardus, M. K. R., Berendsen, H. J. C. An efficient, box shape independent non-bonded force and virial algorithm for molecular dynamics. *Mol. Sim.* 14:137–152, 1995.
- [20] Hockney, R. W., Goel, S. P., Eastwood, J. Quiet High Resolution Computer Models of a Plasma. *J. Comp. Phys.* 14:148–158, 1974.
- [21] Verlet, L. Computer experiments on classical fluids. I. Thermodynamical properties of Lennard-Jones molecules. *Phys. Rev.* 159:98–103, 1967.
- [22] Berendsen, H. J. C., van Gunsteren, W. F. Practical algorithms for dynamics simulations.
- [23] Swope, W. C., Andersen, H. C., Berens, P. H., Wilson, K. R. A computer-simulation method for the calculation of equilibrium-constants for the formation of physical clusters of molecules: Application to small water clusters. *J. Chem. Phys.* 76:637–649, 1982.
- [24] Tuckerman, M., Berne, B. J., Martyna, G. J. Reversible multiple time scale molecular dynamics. *J. Chem. Phys.* 97(3):1990–2001, 1992.
- [25] Berendsen, H. J. C., Postma, J. P. M., DiNola, A., Haak, J. R. Molecular dynamics with coupling to an external bath. *J. Chem. Phys.* 81:3684–3690, 1984.
- [26] Andersen, H. C. Molecular dynamics simulations at constant pressure and/or temperature. *J. Chem. Phys.* 72:2384, 1980.
- [27] Nosé, S. A molecular dynamics method for simulations in the canonical ensemble. *Mol. Phys.* 52:255–268, 1984.

- [28] Hoover, W. G. Canonical dynamics: equilibrium phase-space distributions. *Phys. Rev. A* 31:1695–1697, 1985.
- [29] Bussi, G., Donadio, D., Parrinello, M. Canonical sampling through velocity rescaling. *J. Chem. Phys.* 126:014101, 2007.
- [30] Berendsen, H. J. C. Transport properties computed by linear response through weak coupling to a bath. In: *Computer Simulations in Material Science*. Meyer, M., Pontikis, V. eds. . Kluwer 1991 139–155.
- [31] Cooke, B., Schmidler, S. J. Preserving the Boltzmann ensemble in replica-exchange molecular dynamics. *J. Chem. Phys.* 129:164112, 2008.
- [32] Martyna, G. J., Klein, M. L., Tuckerman, M. E. Nosé-Hoover chains: The canonical ensemble via continuous dynamics. *J. Chem. Phys.* 97:2635–2643, 1992.
- [33] Martyna, G. J., Tuckerman, M. E., Tobias, D. J., Klein, M. L. Explicit reversible integrators for extended systems dynamics. *Mol. Phys.* 87:1117–1157, 1996.
- [34] Holian, B. L., Voter, A. F., Ravelo, R. Thermostatted molecular dynamics: How to avoid the Toda demon hidden in Nosé-Hoover dynamics. *Phys. Rev. E* 52(3):2338–2347, 1995.
- [35] Eastwood, M. P., Stafford, K. A., Lippert, R. A., Jensen, M. O., Maragakis, P., Predescu, C., Dror, R. O., Shaw, D. E. Equipartition and the calculation of temperature in biomolecular simulations. *J. Chem. Theory Comp.* ASAP:DOI: 10.1021/ct9002916, 2010.
- [36] Parrinello, M., Rahman, A. Polymorphic transitions in single crystals: A new molecular dynamics method. *J. Appl. Phys.* 52:7182–7190, 1981.
- [37] Nosé, S., Klein, M. L. Constant pressure molecular dynamics for molecular systems. *Mol. Phys.* 50:1055–1076, 1983.
- [38] Tuckerman, M. E., Alejandre, J., López-Rendón, R., Jochim, A. L., Martyna, G. J. A Liouville-operator derived measure-preserving integrator for molecular dynamics simulations in the isothermal-isobaric ensemble. *J. Phys. A.* 59:5629–5651, 2006.
- [39] Yu, T.-Q., Alejandre, J., Lopez-Rendon, R., Martyna, G. J., Tuckerman, M. E. Measure-preserving integrators for molecular dynamics in the isothermal-isobaric ensemble derived from the liouville operator. *Chem. Phys.* 370:294–305, 2010.
- [40] Dick, B. G., Overhauser, A. W. Theory of the dielectric constants of alkali halide crystals. *Phys. Rev.* 112:90–103, 1958.
- [41] Jordan, P. C., van Maaren, P. J., Mavri, J., van der Spoel, D., Berendsen, H. J. C. Towards phase transferable potential functions: Methodology and application to nitrogen. *J. Chem. Phys.* 103:2272–2285, 1995.
- [42] van Maaren, P. J., van der Spoel, D. Molecular dynamics simulations of a water with a novel shell-model potential. *J. Phys. Chem. B.* 105:2618–2626, 2001.

- [43] Ryckaert, J. P., Ciccotti, G., Berendsen, H. J. C. Numerical integration of the cartesian equations of motion of a system with constraints; molecular dynamics of n-alkanes. *J. Comp. Phys.* 23:327–341, 1977.
- [44] Miyamoto, S., Kollman, P. A. SETTLE: An analytical version of the SHAKE and RATTLE algorithms for rigid water models. *J. Comp. Chem.* 13:952–962, 1992.
- [45] Andersen, H. C. RATTLE: A “Velocity” version of the SHAKE algorithm for molecular dynamics calculations. *J. Comp. Phys.* 52:24–34, 1983.
- [46] Hess, B., Bekker, H., Berendsen, H. J. C., Fraaije, J. G. E. M. LINCS: A linear constraint solver for molecular simulations. *J. Comp. Chem.* 18:1463–1472, 1997.
- [47] Hess, B. P-LINCS: A parallel linear constraint solver for molecular simulation. *J. Chem. Theory Comp.* 4:116–122, 2007.
- [48] van Gunsteren, W. F., Berendsen, H. J. C. A leap-frog algorithm for stochastic dynamics. *Mol. Sim.* 1:173–185, 1988.
- [49] Goga, N., Rzepiela, A. J., de Vries, A. H., Marrink, S. J., Berendsen, H. J. C. Efficient algorithms for Langevin and DPD dynamics. *J. Chem. Theory Comp.* 8:3637–3649, 2012.
- [50] Byrd, R. H., Lu, P., Nocedal, J. A limited memory algorithm for bound constrained optimization. *SIAM J. Scientific. Statistic. Comput.* 16:1190–1208, 1995.
- [51] Zhu, C., Byrd, R. H., Nocedal, J. L-BFGS-B: Algorithm 778: L-BFGS-B, FORTRAN routines for large scale bound constrained optimization. *ACM Trans. Math. Softw.* 23:550–560, 1997.
- [52] Levitt, M., Sander, C., Stern, P. S. The normal modes of a protein: Native bovine pancreatic trypsin inhibitor. *Int. J. Quant. Chem: Quant. Biol. Symp.* 10:181–199, 1983.
- [53] Gō, N., Noguti, T., Nishikawa, T. Dynamics of a small globular protein in terms of low-frequency vibrational modes. *Proc. Natl. Acad. Sci. USA* 80:3696–3700, 1983.
- [54] Brooks, B., Karplus, M. Harmonic dynamics of proteins: Normal modes and fluctuations in bovine pancreatic trypsin inhibitor. *Proc. Natl. Acad. Sci. USA* 80:6571–6575, 1983.
- [55] Hayward, S., Gō, N. Collective variable description of native protein dynamics. *Annu. Rev. Phys. Chem.* 46:223–250, 1995.
- [56] Bennett, C. H. Efficient Estimation of Free Energy Differences from Monte Carlo Data. *J. Comp. Phys.* 22:245–268, 1976.
- [57] Shirts, M. R., Chodera, J. D. Statistically optimal analysis of multiple equilibrium simulations. *J. Chem. Phys.* 129:124105, 2008.
- [58] Hukushima, K., Nemoto, K. Exchange Monte Carlo Method and Application to Spin Glass Simulations. *J. Phys. Soc. Jpn.* 65:1604–1608, 1996.
- [59] Sugita, Y., Okamoto, Y. Replica-exchange molecular dynamics method for protein folding. *Chem. Phys. Lett.* 314:141–151, 1999.

- [60] Seibert, M., Patriksson, A., Hess, B., van der Spoel, D. Reproducible polypeptide folding and structure prediction using molecular dynamics simulations. *J. Mol. Biol.* 354:173–183, 2005.
- [61] Okabe, T., Kawata, M., Okamoto, Y., Mikami, M. Replica-exchange Monte Carlo method for the isobaric-isothermal ensemble. *Chem. Phys. Lett.* 335:435–439, 2001.
- [62] Chodera, J. D., Shirts, M. R. Replica exchange and expanded ensemble simulations as gibbs sampling: Simple improvements for enhanced mixing. *J. Chem. Phys.* 135:194110, 2011.
- [63] de Groot, B. L., Amadei, A., van Aalten, D. M. F., Berendsen, H. J. C. Towards an exhaustive sampling of the configurational spaces of the two forms of the peptide hormone guanylin. *J. Biomol. Str. Dyn.* 13(5):741–751, 1996.
- [64] de Groot, B. L., Amadei, A., Scheek, R. M., van Nuland, N. A. J., Berendsen, H. J. C. An extended sampling of the configurational space of HPr from *E. coli*. *PROTEINS: Struct. Funct. Gen.* 26:314–322, 1996.
- [65] Lange, O. E., Schafer, L. V., Grubmuller, H. Flooding in GROMACS: Accelerated barrier crossings in molecular dynamics. *J. Comp. Chem.* 27:1693–1702, 2006.
- [66] Lyubartsev, A. P., Martsinovski, A. A., Shevkunov, S. V., Vorontsov-Velyaminov, P. N. New approach to Monte Carlo calculation of the free energy: Method of expanded ensembles. *J. Chem. Phys.* 96:1776–1783, 1992.
- [67] Liem, S. Y., Brown, D., Clarke, J. H. R. Molecular dynamics simulations on distributed memory machines. *Comput. Phys. Commun.* 67(2):261–267, 1991.
- [68] Bowers, K. J., Dror, R. O., Shaw, D. E. The midpoint method for parallelization of particle simulations. *J. Chem. Phys.* 124(18):184109–184109, 2006.
- [69] Qiu, D., Shenkin, P., Hollinger, F., Still, W. The GB/SA Continuum Model for Solvation. A Fast Analytical Method for the Calculation of Approximate Born Radii. *J. Phys. Chem. A.* 101:3005–3014, 1997.
- [70] Hawkins, D., Cramer, C., Truhlar, D. Parametrized Models of Aqueous Free Energies of Solvation Based on Pairwise Descreening of Solute Atomic Charges from a Dielectric Medium. *J. Phys. Chem.* 100:19824–19839, 1996.
- [71] Onufriev, A., Bashford, D., Case, D. Exploring protein native states and large-scale conformational changes with a modified Generalized Born model. *PROTEINS: Struct. Funct. Gen.* 55(2):383–394, 2004.
- [72] Larsson, P., Lindahl, E. A High-Performance Parallel-Generalized Born Implementation Enabled by Tabulated Interaction Rescaling. *J. Comp. Chem.* 31(14):2593–2600, 2010.
- [73] Schaefer, M., Bartels, C., Karplus, M. Solution conformations and thermodynamics of structured peptides: molecular dynamics simulation with an implicit solvation model. *J. Mol. Biol.* 284(3):835–848, 1998.

- [74] Tironi, I. G., Sperb, R., Smith, P. E., van Gunsteren, W. F. A generalized reaction field method for molecular dynamics simulations. *J. Chem. Phys.* 102:5451–5459, 1995.
- [75] van der Spoel, D., van Maaren, P. J. The origin of layer structure artifacts in simulations of liquid water. *J. Chem. Theory Comp.* 2:1–11, 2006.
- [76] Berendsen, H. J. C. Electrostatic interactions. In: *Computer Simulation of Biomolecular Systems*. van Gunsteren, W. F., Weiner, P. K., Wilkinson, A. J. eds. . ESCOM Leiden 1993 161–181.
- [77] van Gunsteren, W. F., Billeter, S. R., Eising, A. A., Hünenberger, P. H., Krüger, P., Mark, A. E., Scott, W. R. P., Tironi, I. G. *Biomolecular Simulation: The GROMOS96 manual and user guide*. Zürich, Switzerland: Hochschulverlag AG an der ETH Zürich. 1996.
- [78] van Gunsteren, W. F., Berendsen, H. J. C. *Gromos-87 manual*. Biomos BV Nijenborgh 4, 9747 AG Groningen, The Netherlands 1987.
- [79] Morse, P. M. Diatomic molecules according to the wave mechanics. II. vibrational levels. *Phys. Rev.* 34:57–64, 1929.
- [80] Berendsen, H. J. C., Postma, J. P. M., van Gunsteren, W. F., Hermans, J. Interaction models for water in relation to protein hydration. In: *Intermolecular Forces*. Pullman, B. ed. . D. Reidel Publishing Company Dordrecht 1981 331–342.
- [81] Ferguson, D. M. Parametrization and evaluation of a flexible water model. *J. Comp. Chem.* 16:501–511, 1995.
- [82] Warner Jr., H. R. Kinetic theory and rheology of dilute suspensions of finitely extendible dumbbells. *Ind. Eng. Chem. Fundam.* 11(3):379–387, 1972.
- [83] Brooks, B. R., Brucoleri, R. E., Olafson, B. D., States, D. J., Swaminathan, S., Karplus, M. CHARMM: a program for macromolecular energy, minimization, and dynamics calculation. *J. Comp. Chem.* 4:187–217, 1983.
- [84] Lawrence, C. P., Skinner, J. L. Flexible TIP4P model for molecular dynamics simulation of liquid water. *Chem. Phys. Lett.* 372:842–847, 2003.
- [85] Jorgensen, W. L., Tirado-Rives, J. Potential energy functions for atomic-level simulations of water and organic and biomolecular systems. *Proc. Natl. Acad. Sci. USA* 102:6665–6670, 2005.
- [86] Torda, A. E., Scheek, R. M., van Gunsteren, W. F. Time-dependent distance restraints in molecular dynamics simulations. *Chem. Phys. Lett.* 157:289–294, 1989.
- [87] Hess, B., Scheek, R. M. Orientation restraints in molecular dynamics simulations using time and ensemble averaging. *J. Magn. Reson.* 164:19–27, 2003.
- [88] Thole, B. T. Molecular polarizabilities with a modified dipole interaction. *Chem. Phys.* 59:341–345, 1981.

- [89] Lamoureux, G., Roux, B. Modeling induced polarization with classical drude oscillators: Theory and molecular dynamics simulation algorithm. *J. Phys. Chem. A.* 119:3025–3039, 2004.
- [90] Lamoureux, G., MacKerell, A. D., Roux, B. A simple polarizable model of water based on classical drude oscillators. *J. Phys. Chem. A.* 119:5185–5197, 2004.
- [91] Noskov, S. Y., Lamoureux, G., Roux, B. Molecular dynamics study of hydration in ethanol-water mixtures using a polarizable force field. *J. Phys. Chem. B.* 109:6705–6713, 2005.
- [92] van Gunsteren, W. F., Mark, A. E. Validation of molecular dynamics simulations. *J. Chem. Phys.* 108:6109–6116, 1998.
- [93] Beutler, T. C., Mark, A. E., van Schaik, R. C., Greber, P. R., van Gunsteren, W. F. Avoiding singularities and numerical instabilities in free energy calculations based on molecular simulations. *Chem. Phys. Lett.* 222:529–539, 1994.
- [94] Pham, T. T., Shirts, M. R. Identifying low variance pathways for free energy calculations of molecular transformations in solution phase. *J. Chem. Phys.* 135:034114, 2011.
- [95] Pham, T. T., Shirts, M. R. Optimal pairwise and non-pairwise alchemical pathways for free energy calculations of molecular transformation in solution phase. *J. Chem. Phys.* 136:124120, 2012.
- [96] Jorgensen, W. L., Tirado-Rives, J. The OPLS potential functions for proteins. energy minimizations for crystals of cyclic peptides and crambin. *J. Am. Chem. Soc.* 110:1657–1666, 1988.
- [97] Berendsen, H. J. C., van Gunsteren, W. F. Molecular dynamics simulations: Techniques and approaches. In: *Molecular Liquids-Dynamics and Interactions.* et al., A. J. B. ed. NATO ASI C 135. Reidel Dordrecht, The Netherlands 1984 475–500.
- [98] Allen, M. P., Tildesley, D. J. *Computer Simulations of Liquids.* Oxford: Oxford Science Publications. 1987.
- [99] Ewald, P. P. Die Berechnung optischer und elektrostatischer Gitterpotentiale. *Ann. Phys.* 64:253–287, 1921.
- [100] Hockney, R. W., Eastwood, J. W. *Computer simulation using particles.* New York: McGraw-Hill. 1981.
- [101] Ballenegger, V., Cerdà, J. J., Holm, C. How to convert SPME to P3M: Influence functions and error estimates. *J. Chem. Theory Comp.* 8(3):936–947, 2012.
- [102] van Buuren, A. R., Marrink, S. J., Berendsen, H. J. C. A molecular dynamics study of the decane/water interface. *J. Phys. Chem.* 97:9206–9212, 1993.
- [103] Mark, A. E., van Helden, S. P., Smith, P. E., Janssen, L. H. M., van Gunsteren, W. F. Convergence properties of free energy calculations: α -cyclodextrin complexes as a case study. *J. Am. Chem. Soc.* 116:6293–6302, 1994.

- [104] Jorgensen, W. L., Chandrasekhar, J., Madura, J. D., Impey, R. W., Klein, M. L. Comparison of simple potential functions for simulating liquid water. *J. Chem. Phys.* 79:926–935, 1983.
- [105] van Buuren, A. R., Berendsen, H. J. C. Molecular Dynamics simulation of the stability of a 22 residue alpha-helix in water and 30% trifluoroethanol. *Biopolymers* 33:1159–1166, 1993.
- [106] Liu, H., Müller-Plathe, F., van Gunsteren, W. F. A force field for liquid dimethyl sulfoxide and liquid properties of liquid dimethyl sulfoxide calculated using molecular dynamics simulation. *J. Am. Chem. Soc.* 117:4363–4366, 1995.
- [107] Oostenbrink, C., Villa, A., Mark, A. E., Van Gunsteren, W. F. A biomolecular force field based on the free enthalpy of hydration and solvation: The GROMOS force-field parameter sets 53A5 and 53A6. *Journal of Computational Chemistry* 25(13):1656–1676, 2004.
- [108] Cornell, W. D., Cieplak, P., Bayly, C. I., Gould, I. R., Merz, K. R. Jr., Ferguson, D. M., Spellmeyer, D. C., Fox, T., Caldwell, J. W., Kollman, P. A. A Second Generation Force Field for the Simulation of Proteins, Nucleic Acids, and Organic Molecules. *J. Am. Chem. Soc.* 117(19):5179–5197, 1995.
- [109] Kollman, P. A. Advances and Continuing Challenges in Achieving Realistic and Predictive Simulations of the Properties of Organic and Biological Molecules. *Acc. Chem. Res.* 29(10):461–469, 1996.
- [110] Wang, J., Cieplak, P., Kollman, P. A. How Well Does a Restrained Electrostatic Potential (RESP) Model Perform in Calculating Conformational Energies of Organic and Biological Molecules? *J. Comp. Chem.* 21(12):1049–1074, 2000.
- [111] Hornak, V., Abel, R., Okur, A., Strockbine, B., Roitberg, A., Simmerling, C. Comparison of Multiple Amber Force Fields and Development of Improved Protein Backbone Parameters. *PROTEINS: Struct. Funct. Gen.* 65:712–725, 2006.
- [112] Lindorff-Larsen, K., Piana, S., Palmo, K., Maragakis, P., Klepeis, J. L., Dorris, R. O., Shaw, D. E. Improved side-chain torsion potentials for the AMBER ff99SB protein force field. *PROTEINS: Struct. Funct. Gen.* 78:1950–1958, 2010.
- [113] Duan, Y., Wu, C., Chowdhury, S., Lee, M. C., Xiong, G., Zhang, W., Yang, R., Cieplak, P., Luo, R., Lee, T., Caldwell, J., Wang, J., Kollman, P. A Point-Charge Force Field for Molecular Mechanics Simulations of Proteins Based on Condensed-Phase Quantum Mechanical Calculations. *J. Comp. Chem.* 24(16):1999–2012, 2003.
- [114] García, A. E., Sanbonmatsu, K. Y. α -Helical stabilization by side chain shielding of backbone hydrogen bonds. *Proc. Natl. Acad. Sci. USA* 99(5):2782–2787, 2002.
- [115] MacKerell, J. A. D., Feig, M., Brooks III, C. L. Extending the treatment of backbone energetics in protein force fields: limitations of gas-phase quantum mechanics in reproducing protein conformational distributions in molecular dynamics simulations. *J. Comp. Chem.* 25(11):1400–15, 2004.

- [116] MacKerell, A. D., Bashford, D., Bellott, Dunbrack, R. L., Evanseck, J. D., Field, M. J., Fischer, S., Gao, J., Guo, H., Ha, S., Joseph-McCarthy, D., Kuchnir, L., Kuczera, K., Lau, F. T. K., Mattos, C., Michnick, S., Ngo, T., Nguyen, D. T., Prodhom, B., Reiher, W. E., Roux, B., Schlenkrich, M., Smith, J. C., Stote, R., Straub, J., Watanabe, M., Wiorkiewicz-Kuczera, J., Yin, D., Karplus, M. All-atom empirical potential for molecular modeling and dynamics studies of proteins. *J. Phys. Chem. B.* 102(18):3586–3616, 1998.
- [117] Feller, S. E., MacKerell, A. D. An improved empirical potential energy function for molecular simulations of phospholipids. *J. Phys. Chem. B.* 104(31):7510–7515, 2000.
- [118] Foloppe, N., MacKerell, A. D. All-atom empirical force field for nucleic acids: I. Parameter optimization based on small molecule and condensed phase macromolecular target data. *J. Comp. Chem.* 21(2):86–104, 2000.
- [119] Bjelkmar, P., Larsson, P., Cuendet, M. A., Hess, B., Lindahl, E. Implementation of the CHARMM force field in GROMACS: Analysis of protein stability effects from correction maps, virtual interaction sites, and water models. *J. Chem. Theory Comp.* 6:459–466, 2010.
- [120] Rühle, V., Junghans, C., Lukyanov, A., Kremer, K., Andrienko, D. Versatile Object-Oriented toolkit for Coarse-Graining applications. *J. Chem. Theory Comp.* 5(12):3211–3223, 2009.
- [121] Bereau, T., Wang, Z.-J., Deserno, M. Solvent-free coarse-grained model for unbiased high-resolution protein-lipid interactions. (submitted).
- [122] Wang, Z.-J., Deserno, M. A systematically coarse-grained solvent-free model for quantitative phospholipid bilayer simulations. *J. Phys. Chem. B.* 114(34):11207–11220, 2010.
- [123] IUPAC-IUB Commission on Biochemical Nomenclature. Abbreviations and Symbols for the Description of the Conformation of Polypeptide Chains. Tentative Rules (1969). *Biochemistry* 9:3471–3478, 1970.
- [124] Mahoney, M. W., Jorgensen, W. L. A five-site model for liquid water and the reproduction of the density anomaly by rigid, nonpolarizable potential functions. *J. Chem. Phys.* 112:8910–8922, 2000.
- [125] Ryckaert, J. P., Bellemans, A. Molecular dynamics of liquid alkanes. *Far. Disc. Chem. Soc.* 66:95–106, 1978.
- [126] de Loof, H., Nilsson, L., Rigler, R. Molecular dynamics simulations of galanin in aqueous and nonaqueous solution. *J. Am. Chem. Soc.* 114:4028–4035, 1992.
- [127] van der Spoel, D., van Buuren, A. R., Tieleman, D. P., Berendsen, H. J. C. Molecular dynamics simulations of peptides from BPTI: A closer look at amide-aromatic interactions. *J. Biomol. NMR* 8:229–238, 1996.
- [128] Neumann, R. M. Entropic approach to Brownian Movement. *Am. J. Phys.* 48:354–357, 1980.
- [129] Jarzynski, C. Nonequilibrium equality for free energy differences. *Phys. Rev. Lett.* 78(14):2690 – 2693, 1997.

- [130] O. Engin, M. S. A. Villa, Hess, B. Driving forces for adsorption of amphiphilic peptides to air-water interface. *J. Phys. Chem. B*.
- [131] Kutzner, C., Czub, J., Grubmüller, H. Keep it flexible: Driving macromolecular rotary motions in atomistic simulations with GROMACS. *J. Chem. Theory Comp.* 7:1381–1393, 2011.
- [132] Feenstra, K. A., Hess, B., Berendsen, H. J. C. Improving efficiency of large time-scale molecular dynamics simulations of hydrogen-rich systems. *J. Comp. Chem.* 20:786–798, 1999.
- [133] Hess, B. Determining the shear viscosity of model liquids from molecular dynamics. *J. Chem. Phys.* 116:209–217, 2002.
- [134] Dewar, M. J. S. Development and status of MINDO/3 and MNDO. *J. Mol. Struct.* 100:41, 1983.
- [135] Guest, M. F., Harrison, R. J., van Lenthe, J. H., van Corler, L. C. H. Computational chemistry on the FPS-X64 scientific computers - Experience on single- and multi-processor systems. *Theor. Chim. Act.* 71:117, 1987.
- [136] Frisch, M. J., Trucks, G. W., Schlegel, H. B., Scuseria, G. E., Robb, M. A., Cheeseman, J. R., Montgomery, J. A. Jr., Vreven, T., Kudin, K. N., Burant, J. C., Millam, J. M., Iyengar, S. S., Tomasi, J., Barone, V., Mennucci, B., Cossi, M., Scalmani, G., Rega, N., Petersson, G. A., Nakatsuji, H., Hada, M., Ehara, M., Toyota, K., Fukuda, R., Hasegawa, J., Ishida, M., Nakajima, T., Honda, Y., Kitao, O., Nakai, H., Klene, M., Li, X., Knox, J. E., Hratchian, H. P., Cross, J. B., Bakken, V., Adamo, C., Jaramillo, J., Gomperts, R., Stratmann, R. E., Yazyev, O., Austin, A. J., Cammi, R., Pomelli, C., Ochterski, J. W., Ayala, P. Y., Morokuma, K., Voth, G. A., Salvador, P., Dannenberg, J. J., Zakrzewski, V. G., Dapprich, S., Daniels, A. D., Strain, M. C., Farkas, O., Malick, D. K., Rabuck, A. D., Raghavachari, K., Foresman, J. B., Ortiz, J. V., Cui, Q., Baboul, A. G., Clifford, S., Cioslowski, J., Stefanov, B. B., Liu, G., Liashenko, A., Piskorz, P., Komaromi, I., Martin, R. L., Fox, D. J., Keith, T., Al-Laham, M. A., Peng, C. Y., Nanayakkara, A., Challacombe, M., Gill, P. M. W., Johnson, B., Chen, W., Wong, M. W., Gonzalez, C., Pople, J. A. Gaussian 03, Revision C.02. Gaussian, Inc., Wallingford, CT, 2004.
- [137] Car, R., Parrinello, M. Unified approach for molecular dynamics and density-functional theory. *Phys. Rev. Lett.* 55:2471–2474, 1985.
- [138] Field, M., Bash, P. A., Karplus, M. A combined quantum mechanical and molecular mechanical potential for molecular dynamics simulation. *J. Comp. Chem.* 11:700, 1990.
- [139] Maseras, F., Morokuma, K. IMOMM: A New Ab Initio + Molecular Mechanics Geometry Optimization Scheme of Equilibrium Structures and Transition States. *J. Comp. Chem.* 16:1170–1179, 1995.
- [140] Svensson, M., Humbel, S., Froes, R. D. J., Matsubara, T., Sieber, S., Morokuma, K. ONIOM a multilayered integrated MO + MM method for geometry optimizations and single point energy predictions. a test for Diels-Alder reactions and Pt(P(t-Bu)₃)₂ + H₂ oxidative addition. *J. Phys. Chem.* 100:19357, 1996.

- [141] Praprotnik, M., Delle Site, L., Kremer, K. Adaptive resolution molecular-dynamics simulation: Changing the degrees of freedom on the fly. *J. Chem. Phys.* 123:224106, 2005.
- [142] Praprotnik, M., Delle Site, L., Kremer, K. Multiscale simulation of soft matter: From scale bridging to adaptive resolution. *Annu. Rev. Phys. Chem.* 59:545–571, 2008.
- [143] Junghans, C., Poblete, S. A reference implementation of the adaptive resolution scheme in ESPResSo. *Comp. Phys. Comm.* 181:1449–1454, 2010.
- [144] Fritsch, S., Junghans, C., Kremer, K. Structure formation of toluene around c60: Implementation of the adaptive resolution scheme (adress) into gromacs. *J. Chem. Theory Comp.* 8:398–403, 2012.
- [145] Praprotnik, M., Poblete, S., Kremer, K. Statistical physics problems in adaptive resolution computer simulations of complex fluids. *J. Stat. Phys.* 145:946–966, 2011.
- [146] Delle Site, L. Some fundamental problems for an energy-conserving adaptive-resolution molecular dynamics scheme. *Phys. Rev. E* 76.
- [147] Poblete, S., Praprotnik, M., Kremer, K., Delle Site, L. Coupling different levels of resolution in molecular simulations. *J. Chem. Phys.* 132:114101, 2010.
- [148] Fritsch, S., Poblete, S., Junghans, C., Ciccottii, G., Delle Site, L., Kremer, K. Adaptive resolution molecular dynamics simulation through coupling to an internal particle reservoir. *Phys. Rev. Lett.* 108:170602, 2012.
- [149] van der Spoel, D., Berendsen, H. J. C. Molecular dynamics simulations of Leu-enkephalin in water and DMSO. *Biophys. J.* 72:2032–2041, 1997.
- [150] van der Spoel, D., van Maaren, P. J., Berendsen, H. J. C. A systematic study of water models for molecular simulation. *J. Chem. Phys.* 108:10220–10230, 1998.
- [151] Smith, P. E., van Gunsteren, W. F. The Viscosity of SPC and SPC/E Water. *Comp. Phys. Comm.* 215:315–318, 1993.
- [152] Balasubramanian, S., Mundy, C. J., Klein, M. L. Shear viscosity of polar fluids: Molecular dynamics calculations of water. *J. Chem. Phys.* 105:11190–11195, 1996.
- [153] van der Spoel, D., Vogel, H. J., Berendsen, H. J. C. Molecular dynamics simulations of N-terminal peptides from a nucleotide binding protein. *PROTEINS: Struct. Funct. Gen.* 24:450–466, 1996.
- [154] Amadei, A., Linssen, A. B. M., Berendsen, H. J. C. Essential dynamics of proteins. *PROTEINS: Struct. Funct. Gen.* 17:412–425, 1993.
- [155] Hess, B. Convergence of sampling in protein simulations. *Phys. Rev. E* 65:031910, 2002.
- [156] Hess, B. Similarities between principal components of protein dynamics and random diffusion. *Phys. Rev. E* 62:8438–8448, 2000.
- [157] Mu, Y., Nguyen, P. H., Stock, G. Energy landscape of a small peptide revealed by dihedral angle principal component analysis. *PROTEINS: Struct. Funct. Gen.* 58:45–52, 2005.

- [158] van der Spoel, D., van Maaren, P. J., Larsson, P., Timneanu, N. Thermodynamics of hydrogen bonding in hydrophilic and hydrophobic media. *J. Phys. Chem. B.* 110:4393–4398, 2006.
- [159] Luzar, A., Chandler, D. Hydrogen-bond kinetics in liquid water. *Nature* 379:55–57, 1996.
- [160] Luzar, A. Resolving the hydrogen bond dynamics conundrum. *J. Chem. Phys.* 113:10663–10675, 2000.
- [161] Kabsch, W., Sander, C. Dictionary of protein secondary structure: Pattern recognition of hydrogen-bonded and geometrical features. *Biopolymers* 22:2577–2637, 1983.
- [162] Williamson, M. P., Asakura, T. Empirical comparisons of models for chemical-shift calculation in proteins. *J. Magn. Reson. Ser. B* 101:63–71, 1993.
- [163] Bekker, H., Berendsen, H. J. C., Dijkstra, E. J., Achterop, S., v. Drunen, R., v. d. Spoel, D., Sijbers, A., Keegstra, H., Reitsma, B., Renardus, M. K. R. Gromacs Method of Virial Calculation Using a Single Sum. In *Physics Computing 92* (Singapore, 1993). de Groot, R. A., Nadrchal, J., eds. . World Scientific.
- [164] Berendsen, H. J. C., Grigera, J. R., Straatsma, T. P. The missing term in effective pair potentials. *J. Phys. Chem.* 91:6269–6271, 1987.
- [165] Bekker, H. Ontwerp van een special-purpose computer voor moleculaire dynamica simulaties. Master's thesis. RuG. 1987.
- [166] van Gunsteren, W. F., Berendsen, H. J. C. Molecular dynamics of simple systems. Practicum Handleiding voor MD Practicum Nijenborgh 4, 9747 AG, Groningen, The Netherlands 1994.

Index

- τ_T 32
 ϵ_r 70
1-4 interaction 80, 118
- A**
accelerate group 15
Adaptive Resolution Scheme 176
adding atom types 147
AdResS *see* Adaptive Resolution Scheme
AMBER force field 110
Andersen thermostat 32
angle
 restraint 84
 vibration 76
annealing, simulated
 see simulated annealing
atom *see* particle
 type 114
 types, adding *see* adding atom types
autocorrelation function 233
average, ensemble *see* ensemble average
- B**
BAR 54
Bennett's acceptance ratio 54
Berendsen pressure coupling
 see pressure coupling, Berendsen
 see temperature coupling, Berendsen
bond stretching 74
bonded parameter 117
Born-Oppenheimer 4
branched polymers 129
Brownian dynamics 50
Buckingham potential 69
building block 116
- C**
center of mass group 15
center-of-mass
 pulling 151
 velocity 18
charge group 19, 23, 24, 98, 193
CHARMM force field 110
chemistry, computational
 see computational chemistry
choosing groups 228
citing iv
CMAP 110
combination rule 68, 117, 137
compressibility 36
computational chemistry 1
conjugate gradient 51, 186
connection 120
constant, dielectric *see* dielectric constant
constraint 4
 algorithms 45, 120, 202
 force 144
 pulling 152
constraints 25, 60
correlation 233
Coulomb 69, 94
covariance analysis 239
cut-off 4, 71, 98, 195, 196
Cut-off schemes 19
- D**
database
 hydrogen \sim *see* hydrogen database
 termini \sim *see* termini database
default groups 228
deform 217
degrees of freedom 165
dielectric constant 70, 195
diffusion coefficient 235
dihedral 80
 restraint 84

- improper ~ *see* improper dihedral
 - proper ~ *see* proper dihedral
 - dipolar couplings 88
 - dispersion 67
 - correction 103, 196
 - distance restraint 85, 208
 - ensemble-averaged ~
 - see* ensemble-averaged distance restraint
 - time-averaged ~
 - see* time-averaged distance restraint
 - disulfide bonds 129
 - do_dssp 243, 254, 274
 - do_multiprot 254
 - do_shift 245, 254
 - dodecahedron 13
 - domain decomposition 58
 - double precision *see* precision, double
 - Drude 92
 - dummy atoms *see* virtual interaction sites
 - dynamic load balancing 59
 - dynamics
 - Brownian ~ *see* Brownian dynamics
 - Langevin ~ *see* Langevin dynamics
 - mesoscopic ~
 - see* mesoscopic dynamics
 - stochastic ~ *see* stochastic dynamics
- E**
- editconf 275
 - Einstein relation 235
 - electric field 217
 - electrostatics 193
 - eneconv 254, 277
 - energy
 - file 268
 - minimization 50, 188
 - kinetic ~ *see* kinetic energy
 - potential ~ *see* potential energy
 - energy-monitor group 15
 - Enforced Rotation 154
 - ensemble average 1
 - ensemble-averaged distance restraint 87
 - environment variables 248
 - equation, Schrödinger
 - see* Schrödinger equation
 - equations of motion 2, 26
 - equilibration 269
 - essential dynamics 56
 - Ewald
 - sum 73, 105, 193
 - particle-mesh ~ 73
 - exclusions 15, 97, 120, 204
 - Expanded Ensemble 57
 - calculations 213
 - extended ensemble 33
- F**
- FENE potential 76
 - file
 - type 183
 - energy ~ *see* energy file
 - index ~ *see* index file
 - log ~ *see* log file
 - topology ~ *see* topology file
 - trajectory ~ *see* trajectory file
 - files, GROMOS96 *see* GROMOS96 files
 - flooding 57
 - force
 - decomposition 58
 - force field 4, 67, 107, 146
 - organization 145
 - force-field, coarse-grained 110
 - Fortran 261
 - free energy
 - calculations 52, 165, 209
 - interactions 92
 - topologies 141
 - freedom, degrees of *see* degrees of freedom
 - freeze group 15, 42
 - frozen atoms 15, 42
- G**
- g_anadock 277
 - g_anaeig 240, 278
 - g_analyze 240, 280
 - g_angle 236, 282
 - g_bar 55, 283
 - g_bond 235, 284
 - g_bundle 285
 - g_chi 286
 - g_cluster 254, 288
 - g_clustsize 290

- | | | | |
|---------------|-------------------------|--------------------------|---------------------------------------|
| g_confrms | 291 | g_sans | 338 |
| g_covar | 240, 253, 291 | g_sas | 339 |
| g_current | 292 | g_select | 228, 230, 340 |
| g_density | 245, 293 | g_sgangle | 236, 237, 342 |
| g_densmap | 294 | g_sham | 343 |
| g_densorder | 295 | g_sigeps | 344 |
| g_dielectric | 296 | g_sorient | 344 |
| g_dipoles | 234, 254, 297 | g_spatial | 345 |
| g_disre | 299 | g_spol | 347 |
| g_dist | 299 | g_tcaf | 347 |
| g_dos | 300 | g_traj | 231, 245, 348 |
| g_dyecoupl | 301 | g_tune_pme | 253, 350 |
| g_dyndom | 302 | g_vanhove | 352 |
| g_enemat | 304 | g_velacc | 234, 353 |
| g_energy | 231, 235, 254, 270, 305 | g_wham | 254, 354 |
| g_filter | 309 | g_wheel | 243, 357 |
| g_gyrate | 237, 310 | g_x2top | 357 |
| g_h2order | 311 | g_xrama | 243, 358 |
| g_hbond | 241, 312 | genbox | 302 |
| g_helix | 314 | genconf | 304 |
| g_helixorient | 315 | Generalized Born methods | 63 |
| g_hydorder | 316 | genion | 139, 308 |
| g_kinetics | 316 | genrestr | 309 |
| g_lie | 317 | gmxccheck | 323 |
| g_mdmat | 237, 318 | gmxdump | 323 |
| g_membed | 318 | GMXRC | 248 |
| g_mindist | 237, 320 | GPUs | 255 |
| g_morph | 321 | grid search | 23 |
| g_msdl | 235, 321 | GROMOS87 | 108 |
| g_nmeig | 52, 253, 324 | force field | 108 |
| g_nmens | 52, 325 | GROMOS96 | |
| g_nmtraj | 326 | files | 109 |
| g_order | 243, 326 | force field | 108 |
| g_pme_error | 327 | grompp | 117, 118, 138, 139, 166, 254, 335 |
| g_polystat | 328 | group | 14 |
| g_potential | 245, 328 | accelerate ~ | <i>see</i> accelerate group |
| g_principal | 329 | center of mass ~ | <i>see</i> center of mass group |
| g_protonate | 330 | charge ~ | <i>see</i> charge group |
| g_rama | 243, 330 | energy-monitor ~ | <i>see</i> energy-monitor group |
| g_rdf | 231, 330 | freeze ~ | <i>see</i> freeze group |
| g_rms | 238, 332 | planar ~ | <i>see</i> planar group |
| g_rmsdist | 239, 333 | temperature-coupling ~ | <i>see</i> temperature-coupling group |
| g_rmsf | 334 | XTC output ~ | <i>see</i> XTC output group |
| g_rotacf | 234, 336 | | |
| g_rotmat | 337 | | |
| g_saltbr | 338 | | |

- groups 139, 227
 choosing ~ *see* choosing groups
 default ~ *see* default groups
- H**
 harmonic interaction 120
 heme group 129
 Hessian 52
 html manual 183
 hydrogen database 125
- I**
 image, nearest *see* nearest image
 implicit solvation 63
 parameters 119
 improper dihedral 79
 index file 228
 install 247
 integration timestep 76
 integrator
 leap-frog ~ *see* leap-frog integrator
 velocity Verlet ~
see velocity Verlet integrator
 interaction list 97
 intramolecular pair interaction 118
 isothermal compressibility 36
- K**
 kinetic energy 25
- L**
 L-BFGS 51
 Langevin dynamics 49, 188
 leap-frog integrator 26, 185
 Lennard-Jones 68, 94
 limitations 3
 LINCS 46, 60, 95, 203
 list, interaction *see* interaction list
 load balancing, dynamic
see dynamic load balancing
 log file 189, 269
- M**
 make_edi 359
 make_ndx 228, 361
 Martini force field 111
 mass, modified *see* modified mass
- Maxwell-Boltzmann distribution 17
 MD
 units 7
 non-equilibrium ~
see non-equilibrium MD
 mdrun 251–253, 361
 mdrun-gpu 254
 mechanics, statistical
see statistical mechanics
 mesoscopic dynamics 2
 mirror image
 minimum image convention 12, 14
 79
 mk_angndx 228, 367
 modeling, molecular
see molecular modeling
 modified mass 166
 molecular modeling 1
 Morse potential 75
 motion, equations of
see equations of motion
 multiple time step 29
- N**
 nearest image 18
 neighbor
 list 18, 190
 searching 18, 190
 third ~ *see* third neighbor
 ngmx 230, 249, 254, 367
 NMA 52
 NMR refinement 208
 85
 non-bonded parameter 116
 non-equilibrium MD 15, 217
 normal-mode analysis 52, 187
 Nosé-Hoover temperature coupling
see temperature coupling, Nosé-Hoover
- O**
 octahedron 13
 online manual 183
 OpenMP 255
 OPLS/AA force field 110
 options
 standard 273

- orientation restraint 88, 209
- P**
- P-LINCS 60
- P3M-AD 107, 193
- parabolic force 72
- parallelization 57
- parameter 113
- bonded ~ *see* bonded parameter
 - non-bonded ~ *see* non-bonded parameter
 - run ~ *see* run parameter
- Parrinello-Rahman pressure coupling *see* pressure coupling, Parrinello-Rahman
- particle 113
- decomposition 58
- particle-mesh Ewald *see* PME
- Particle-Particle Particle-Mesh *see* P3M
- PCA *see* covariance analysis
- pdb2gmx 80, 83, 110, 116, 121, 129, 166, 368
- pencil decomposition 63
- performance 261
- periodic boundary conditions 11, 105, 257
- planar group 79
- PLUM force field 111
- PME 62, 106, 193
- Poisson solver 72
- polarizability 44
- position restraint 83, 185
- potential
- energy 25
 - function 108, 171
- potentials of mean force 165
- precision
- double ~ 247
 - single ~ 247
- pressure 25
- pressure coupling 36, 199
- Berendsen ~ 36
 - Parrinello-Rahman ~ 37
 - surface-tension ~ 38
- principal component analysis 56
- programs by topic 222
- proper dihedral 80
- pulling 205
- constraint ~ *see* constraint pulling
 - rotational ~ *see* enforced rotation
 - umbrella ~ *see* umbrella pulling
- Q**
- QSAR 1
- quadrupole 114
- quasi-Newtonian 186
- R**
- reaction field 70, 94
- reaction-field electrostatics 193
- reduced units 9
- refinement,nmr 85
- REMD 55
- removing COM motion 15, 18
- replica exchange 55
- repulsion 67
- residuetypes.dat 122, 229
- restraint
- angle ~ *see* angle restraint
 - dihedral ~ *see* dihedral restraint
 - distance ~ *see* distance restraint
 - orientation ~ *see* orientation restraint
 - position ~ *see* position restraint
- rhombic dodecahedron 11
- rotational pulling *see* enforced rotation
- run parameter 185
- S**
- sampling 44
- Schrödinger equation 1
- search
- grid ~ *see* grid search
 - simple ~ *see* simple search
- searching, neighbor *see* neighbor searching
- SETTLE 46, 120
- SHAKE 45, 95, 203
- shear 217
- shell 92
- model 44
 - molecular dynamics 188
- simple search 23
- simulated annealing 48, 201
- single precision *see* precision, single
- slow-growth methods 52
- soft-core interactions 95

- solver, Poisson *see* Poisson solver
 specbond.dat 129
 statistical mechanics 2
 steepest descent 50, 186
 stochastic dynamics 2, 49
 strain 217
 stretching, bond *see* bond stretching
 surface-tension pressure coupling
see pressure coupling, surface-tension
- T**
- tabulated
 bonded interaction function 82
 interaction functions 170
 targeted MD 165
 temperature 25
 temperature coupling 14, 30, 198
 Nosé-Hoover 33
 Berendsen ~ 31
 velocity-rescaling ~ 32
 temperature-coupling group 14, 25, 35
 termini database 126
 thermodynamic integration 54
 third neighbor 97
 Thole 92
 time lag 233
 time-averaged distance restraint 86
 timestep, integration
 see integration timestep
 topology 113
 file 130
 tpbconv 370
 trajectory file 44, 189
 triclinic unit cell 12
 trjcat 371
 trjconv 372
 trjorder 374
 truncated octahedron 11
 twin-range
 cut-off 29
 type
 atom ~ *see* atom type
 file ~ *see* file type
- U**
- umbrella pulling 152
- units 7
 Urey-Bradley bond-angle vibration 78
- V**
- velocity
 Verlet integrator 26
 center-of-mass ~
 see center-of-mass velocity
 velocity-rescaling temperature coupling
 see temperature coupling, velocity-rescaling
 Versatile Object-oriented Toolkit for Coarse-
 Graining Applications (VOTCA) 111
 vibration
 angle ~ *see* angle vibration
 Urey-Bradley bond-angle ~
 see Urey-Bradley bond-angle vibration
 virial 25, 98, 99, 257
 virtual interaction sites 99, 114, 166
 viscosity 168, 217, 235
 VOTCA package 178
- W**
- walls 204
 water 75
 weak coupling 31, 36
- X**
- XDR 183
 xmgr 233, 271
 xpm2ps 375
 XTC 15
 output group 15